

SPECIAL SERVICE FEATURE ISSUE

RADIO & TELEVISION NEWS

MARCH

1956

35 CENTS

in U.S. and Canada

World's Leading Electronics Magazine

IN THIS ISSUE

**COLOR TV TROUBLE
IN BLACK-AND-WHITE SETS**

**TRANSISTOR
SERVICING PRECAUTIONS**

**HOME TAPE RECORDERS
Planning Your Purchase**

NEW TUBE FOR U. H. F. TV

SERVICING YOUR V. T. V. M.

NEW TV RECEIVING TUBES

1956 EMERSON TEST POINTS

**TUNING AND LOADING TWO-WAY
FM MOBILE TRANSMITTERS**

**TAPE SYSTEM YOU CAN BUILD
Playback Preamp**

**GUIDED MISSILES
Maintenance
(See Page 35)**

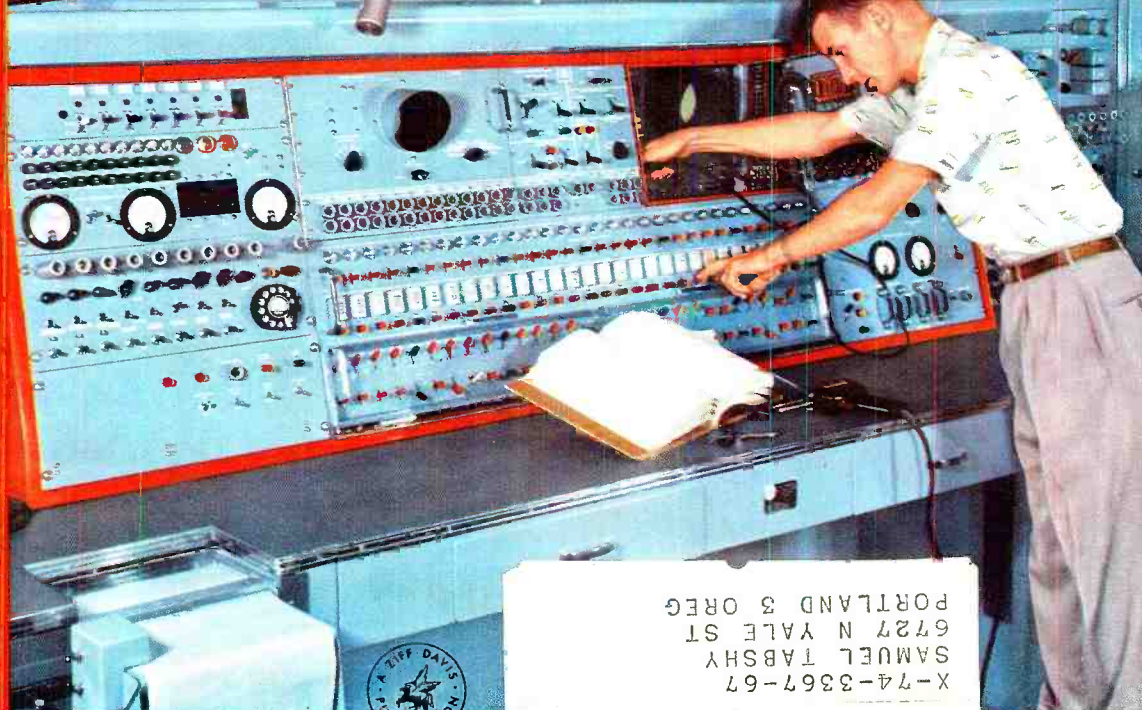
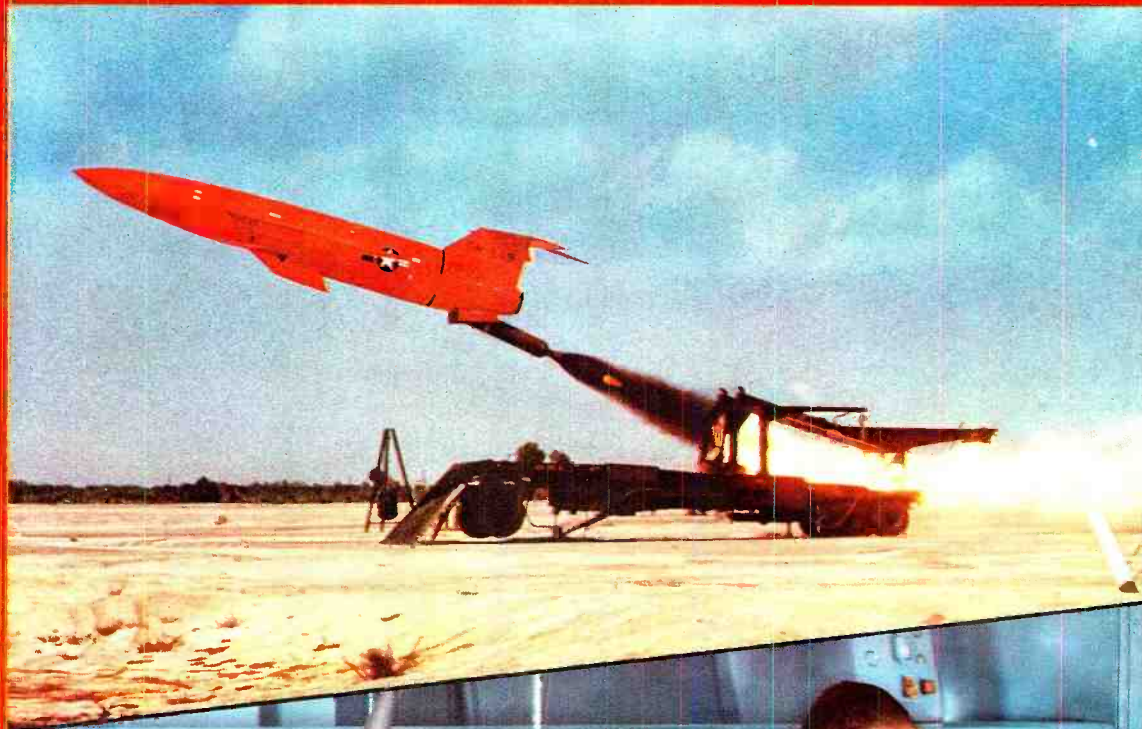

X-74-3367-67
SAMUEL TABSHY
6727 N YALE ST
PORTLAND 3 OREG

...STOP UNWANTED SOUNDS

with the NEW **664** VARIABLE D*



CARDIOID for P.A.

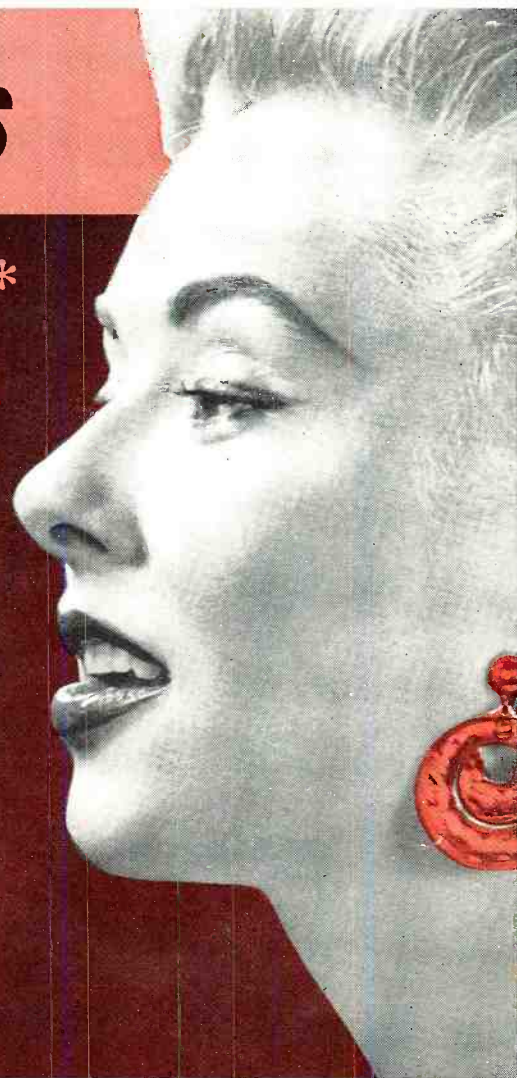

Now... Broadcast Performance Designed for Public Address

**COMPLETELY NEW ALL-PURPOSE CARDIOID DYNAMIC MICROPHONE
BRINGS NEW EFFICIENCY OVER WIDE FREQUENCY RANGE**

All the advantages of the E-V Variable D* are now available in the new high-fidelity "664"...for public address, recording, communications and similar applications. Uniform cardioid polar pattern provides high front-to-back discrimination against unwanted sounds, without close-talking boominess. Easily solves sound pick-up and reproduction problems under a great variety of conditions. Gives distinct, natural reproduction of voice and music. Increases working distance from microphone. Gives greater protection against feedback. Especially useful where ambient noise and severe reverberation exist. Pop-proof filter minimizes wind and breath blasts. E-V Acoustalloy diaphragm guarantees smooth wide-range reproduction. Can be used on a floor or desk stand or carried in the hand. No finer microphone for performance and value! *Write for Technical Specification Sheet.*

*EV Pat. Pend.

Model 664. Variable D* Super-Cardioid Dynamic Microphone. Uniform response at all frequencies from 60 to 13,000 cps. Output level -55 db. 150 ohm and high impedance. Impedance changed by moving one connection in connector. Line balanced to ground and phased. Acoustalloy diaphragm, shielded from dust and magnetic particles. Alnico V and Armo magnetic iron in non-welded circuit. Swivel permits aiming directly at sound source for most effective pick-up. Pressure cast case. $\frac{3}{8}$ "-27 thread. Satin chrome finish. 18 ft. cable with MC4M connector. On-Off switch. Size: $1\frac{1}{2}$ in. diam. $7\frac{3}{8}$ in. long not including stud. Net wt.: 1 lb. 10 oz. List Price **\$79.50**

Model 419 Desk Stand available for use with the "664" (extra).

Electro-Voice®

ELECTRO-VOICE, INC. • BUCHANAN, MICH.

Export: 13 East 40th Street, New York 16, N. Y. U. S. A. Cables: Arlab

HIGH-FIDELITY MICROPHONES • SPEAKER SYSTEMS • PHONO-CARTRIDGES • AND OTHER ELECTRO-ACOUSTIC PRODUCTS

www.americanradiohistory.com

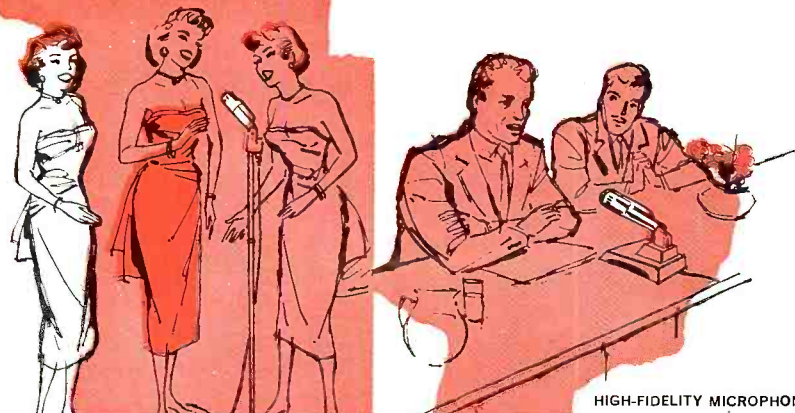

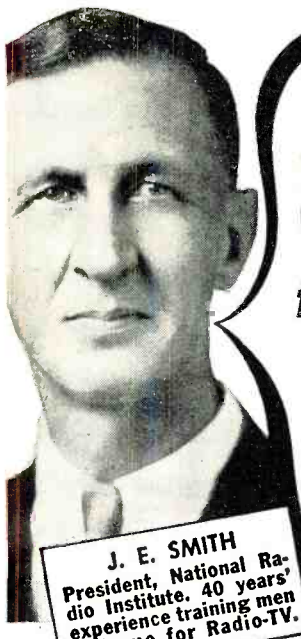

J. E. SMITH
President, National Radio Institute. 40 years' experience training men at home for Radio-TV.

I Will Send You A
SAMPLE LESSON FREE
to show you how easy, practical it is to
Train at Home for Good Radio-Television Jobs

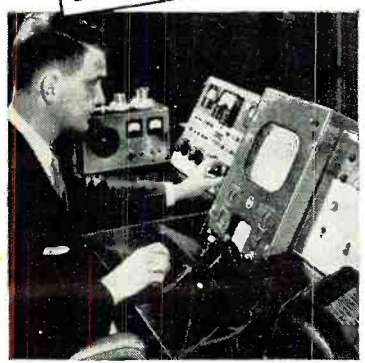

Make \$10, \$15 a Week Extra
Many men I train fix neighbors' Radios, make extra money, soon after they enroll. Actual equipment you build gives you practical experience.

America's Fast Growing Industry Offers You Good Pay Plus a Bright Future

TRAINING plus OPPORTUNITY is the PERFECT combination for ambitious men. Let me send you a sample lesson from my course to prove you can keep your job while TRAINING at home in your spare time for better pay and a brighter future. I will also send my 64-page book to show you that Radio-Television is today's field of OPPORTUNITY for properly trained men.

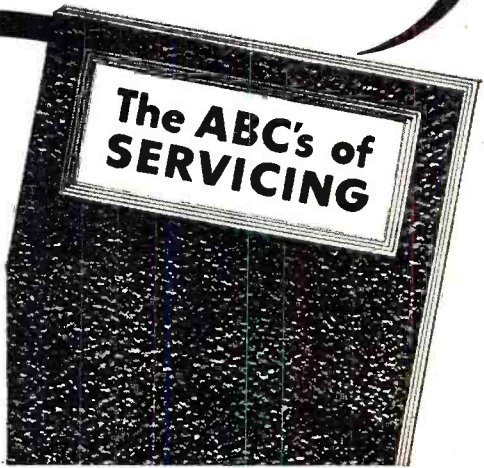

Television's Growth is Making More Jobs, Prosperity

Radio is bigger than ever and television is growing fast. Government, Aviation, Police, Ship, Microwave Relay, Two Way Communications for buses, taxis, railroads are other growing fields for Radio-Television trained men.

I Trained These Men

"I have a regular job as a police captain and also have a good spare time Radio and Television service business. Just opened my new showrooms and shop."—C. W. LEWIS, Pensacola, Florida.

"I decided to quit my job and do TV work full time. I love my work and am doing all right. If fellows knew what a wonderful investment NRI is, they would not hesitate."—W. F. KLINE, Cincinnati, Ohio.

"Thanks to NRI, I operated a successful Radio repair shop. Then I got a job with WPAQ, later WBOB and now am an engineer for WHPE."—VAN W. WORKMAN, High Point, N. Carolina.

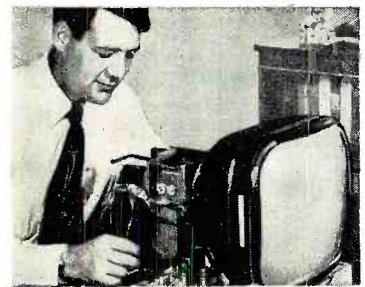

Mail Coupon—Find Out About This Tested Way to Better Pay

Take NRI training for as little as \$5 a month. Many NRI graduates make more in two weeks than the total cost of my training. Mail coupon today for Actual Lesson and 64-page Book—Both FREE. J. E. SMITH, National Radio Institute, Dept. 6CE Washington 9, D. C. Our 40th Year.

You Learn by Practicing with Equipment I Send



Nothing takes the place of practical experience. That's why NRI training is based on LEARNING BY DOING. My training includes kits of parts which you use to build equipment and get practical experience on circuits common to both Radio and Television. Shown at left is the low-power Broadcasting Transmitter you build as part of my Communications Course.



AVAILABLE TO **VETERANS** UNDER G.I. BILLS

Good for Both—FREE

Mr. J. E. Smith, President, Dept. 6CE
National Radio Institute, Washington 9, D.C.
Mail me Sample Lesson and 64-page Book, FREE.
(No salesman will call. Please write plainly.)

Name _____ Age _____
Address _____
City _____ Zone _____ State _____
VETS write in date of discharge _____
Approved Member, National Home Study Council

RADIO & TELEVISION NEWS is published monthly by Ziff-Davis Publishing Company, William B. Ziff, Chairman of the Board (1946-1953), at 64 E. Lake St., Chicago 1, Ill. Entered as second-class matter July 21, 1948, at the Post Office, Chicago, Ill., under the act of March 3, 1879. Authorized by Post Office Department, Ottawa, Canada, as second-class matter. SUBSCRIPTION RATES: Radio & Television News—one year U. S. and possessions, and Canada \$4.00; Pan-American Union countries \$4.50; all other foreign countries \$5.00.

Editor and Asst. Publisher
OLIVER READ, D.Sc., WJETI
 Managing Editor
WM. A. STOCKLIN, B. S.
 Technical Editor
H. S. RENNE, M. S.
 Service Editor
CHARLES TEPPER
 Associate Editor
P. B. HOEFER
 Assistant Editor
J. JUSTER
 Television Consultant
WALTER H. BUCHSBAUM
 Art Editor
FRANK SAYLES
 Draftsmen
J. A. GOLANEK
W. K. VAHLSING
 Advertising Director
L. L. OSTEN
 Advertising Manager
MURRAY GOLDMAN
 Midwest Adv. Manager
JOHN A. RONAN, JR.
 Western Adv. Manager
JOHN E. PAYNE



*First in radio-
 television-audio-electronics*

Average Net Paid Circulation 235,788

Radio News Trademark Reg. U. S. Pat. Office • Television News Trademark Reg. U. S. Pat. Office.

Reg. U. S. Pat. Off.

CONTENTS

MARCH, 1956

EDITORIAL—INDUSTRY NEWS

For the Record.....	O. Read	8
Spot Radio News.....	Washington Correspondent	16
The Future of Servicing—Guest Editorial.....	Dr. W. R. G. Baker	31
New TV Stations on the Air.....		182
New TV Grants Since Freeze Lift.....		182

HIGH-FIDELITY AND AUDIO

Home Tape Recorders—Planning Your Purchase.....	Herman Burstein	39
A Tape System You Can Build—Playback Preamplifier (Part 2).....	John L. MacAllister	49
.....	Bert Whyte	62
Certified Record Revue.....	Oliver Read & James Riley	64
Evolution of the Phonograph (Part 5).....		89
New Hi-Fi-Audio Equipment.....		100
A New FM Tuner.....	Harold Reed	112
Simplifying Tone Control Circuits.....	Richard H. Dorf	130
Non-Clipping Wave Squarer.....		

SERVICING

Television-Radio

Guided Missiles—Maintenance.....	Sam F. Kennedy	35
New TV Receiving Tubes.....	Robert B. Gary	38
Color TV Trouble in Black-and-White Sets.....	George C. Chernish	42
Tube Inventory for Service Shops.....	Murray Barlowe	44
Get a "New Look" into Your Service Shop.....		45
New Tube for U.H.F. TV.....	D. D. Mickey, Jr. & J. W. Rush	46
Auto Radio Search Tuners.....	James A. McRoberts	48
Transistor Servicing Precautions.....	Milton S. Kiver	53
The Art of Pulling a Chassis.....	Art Margolis	56
1956 Emerson Test Points.....	Harold Bernstein	58
Servicing Record Changers.....	E. Eugene Ecklund	60
New Picture Tubes for 1956.....	Walter H. Buchsbaum	63
Flying TV Service.....	Dean Smith	69
A Review of Servicing Techniques.....	Louis E. Garner, Jr.	70
Mac's Service Shop.....	John T. Frye	74
Horizontal Sweep—Questions & Answers.....	Jesse Dines	102
Antenna News.....		173
Radio-TV Service Industry News.....		176

Test Equipment

Servicing Your V.T.V.M.....	Sol Heller & Peter Orne	66
New Tube Tester Data.....		96
Using Your Test Equipment.....	Mel Byron	127
New Test Equipment for Servicing.....		141

AMATEUR—COMMUNICATIONS

Tuning and Loading Two-Way FM Mobile Transmitters.....	Jack Darr	52
Bandswitching Wavemeter.....	Robert J. Ropes, W9PAP	134

ELECTRONIC DESIGN

Remote Switching Circuit.....	Warner Clements	106
Safety Diode Protects Transistors.....	Rufus P. Turner	146

DEPARTMENTS

Within the Industry.....	26	Sales Aids.....	148
What's New in Radio.....	120	Technical Books.....	162
Manufacturers' Literature.....	170		

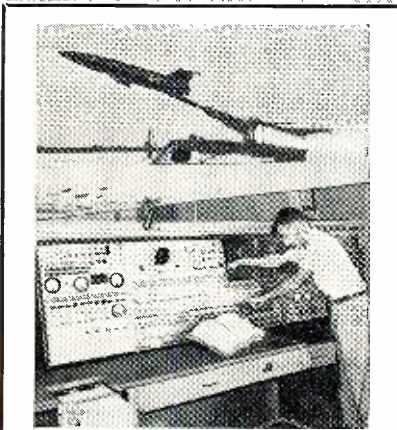

COVER PHOTO: (Top) First instant of flight of a TM-61 tactical missile during test at Cape Canaveral, Fla. (Bottom) Technician troubleshooting the complex digital filming system used in guided missile research. (Ektachrome—Official USAF Photo)

ZIFF-DAVIS PUBLISHING COMPANY

President
B. G. DAVIS
 Vice-Presidents
H. J. MORGANROTH
M. H. FROELICH
 Secretary-Treasurer
G. E. CARNEY
 Circulation Manager
M. MICHAELSON

BRANCH OFFICES

CHICAGO (1)
 64 E. Lake St., AN 3-5200
 LOS ANGELES (14)
 Sterler Center, 900 Wilshire Blvd., MI 4-9836



ZIFF-DAVIS PUBLISHING COMPANY
 WILLIAM B. ZIFF (1898-1953) FOUNDER
 Editorial and Executive Offices
 366 Madison Ave., New York 17, N. Y.
 VOLUME 55 • NUMBER 3



Member
 Audit Bureau of
 Circulations

Copyright 1956 by Ziff-Davis Publishing Company. All rights reserved.

SUBSCRIPTION SERVICE: All communications concerning subscriptions should be addressed to Circulation Dept., 64 E. Lake St., Chicago 1, Ill. Subscribers should allow at least four weeks for change of address. Include your old address as well as new—enclosing, if possible, an address label from a recent issue of this magazine.

CONTRIBUTIONS: Contributors are advised to retain a copy of their manuscripts and illustrations. Contributions should be mailed to the New York Editorial Office and must be accompanied by return postage. Contributions will be handled with reasonable care, but this magazine assumes no responsibility for their safety. Any copy accepted is subject to whatever adaptations and revisions are necessary to meet the requirements of this publication. Payment covers all author's, contributor's, and contestant's rights, title, and interest in and to the material accepted and will be made at our current rates upon acceptance. All photos and drawings will be considered as part of the material purchased.

Now IN YOUR OWN HOME Learn

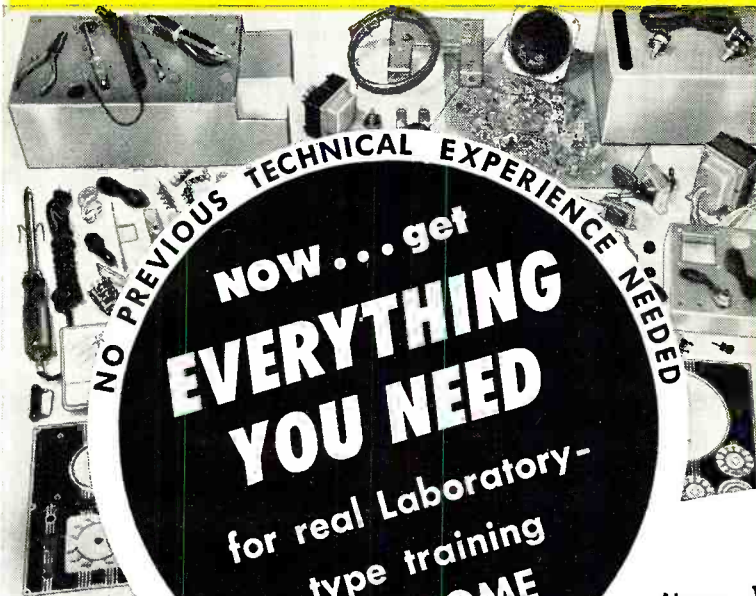

NO PREVIOUS TECHNICAL EXPERIENCE NEEDED

NOW... get
EVERYTHING YOU NEED
for real Laboratory-type training
AT HOME



OSCILLOSCOPE

VACUUM TUBE VOLTMETER



21 INCH

Build and keep this BIG DTI Engineered TV set—easily converted to U.H.F. (DTI offers another home training, but without the TV set.)

1. Build over 300 fascinating experiments from 16 BIG SHIPMENTS of Electronic-Radio parts which you KEEP.
2. Build valuable commercial-type test equipment—as shown to the left—which you KEEP. This includes a quality 5 INCH oscilloscope and vacuum tube voltmeter—both highly useful for Television work.
3. Build and keep a big 21 INCH TV Set. (D.T.I. offers another home training in Television-Radio-Electronics, but without the TV set.)
4. Use a 16 mm. movie projector and new series of highly instructive movies—a wonderful aid to help you grasp important fundamentals faster . . . easier . . . better.
5. Enjoy well-illustrated, easy-to-read lessons with handy FOLD-OUT diagrams.
6. Get an honest-to-goodness EMPLOYMENT SERVICE to help you get a good job after graduating—or assistance in starting your OWN SALES AND SERVICE BUSINESS. Mail coupon today for the complete details.

D.T.I.'s Training is available in Canada



HOME MOVIES

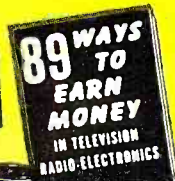

Get this information-packed publication

FREE!

Mail Coupon Today

AUTOMATION
ELECTRONICS

TELEVISION

RADIO-ELECTRONICS

the Amazingly Effective

D.T.I. WAY

—with the aid of BOTH HOME EQUIPMENT and HOME MOVIES

Above: Work over 300 fascinating experiments with this equipment

What will mailing the coupon below do for YOU? Just this! You'll find out about one of today's most remarkable . . . practical ways to prepare to get into America's amazing billion dollar opportunity field of TELEVISION-RADIO-ELECTRONICS. You'll see how to get into fascinating work that pays well . . . that offers one of America's most promising futures . . . that enables you to start your own business almost "on a shoe string," if you prefer this to a job opportunity.

And above all, you'll get some GOOD NEWS especially welcomed by men anxious to earn REAL MONEY in this thrilling field. For you'll see that NOW you can get the kind of practical, laboratory-type training so desirable for making real progress in Television-Radio-Electronics AND WITHOUT LEAVING HOME.

You'll see that DeVry Technical Institute sends everything needed to set up your own HOME LABORATORY.

You get and keep the same type of basic electronic equipment used in our modern Chicago Training Laboratories. You get home training that includes the knowledge and experience gained from training thousands of students first hand in Chicago. And to top it all, you use DTI's amazingly effective and exclusive home training aid—INSTRUCTIVE MOVIES. But why not get the complete story? Mail coupon today for information-packed literature.

MODERN LABORATORIES

If you prefer, get all your preparation in our new Chicago Training Laboratories—one of the finest of its kind. Ample instructors, modern equipment. Write for details!

MILITARY SERVICE!

If you're subject to military service, the information we have for you should prove very helpful. Mail coupon today.



"One of America's Foremost Electronics Training Centers"

DEVRY TECHNICAL INSTITUTE
CHICAGO 41, ILLINOIS
FORMERLY
DEFOREST'S TRAINING, INC.



DEVRY TECHNICAL INSTITUTE MEMBER OF NATIONAL HOME STUDY COUNCIL
4141 BELMONT AVE., CHICAGO 41, ILL.

I would like your Opportunity News Bulletin showing "89 Ways to Earn Money In Television-Radio-Electronics"; also, complete facts about the training opportunity made possible by your organization.

Name _____ Age _____
Address _____ (PLEASE PRINT) Apt. _____
City _____ Zone _____ State _____
Dept. RN-3-M

the fastest selling
ROTORS

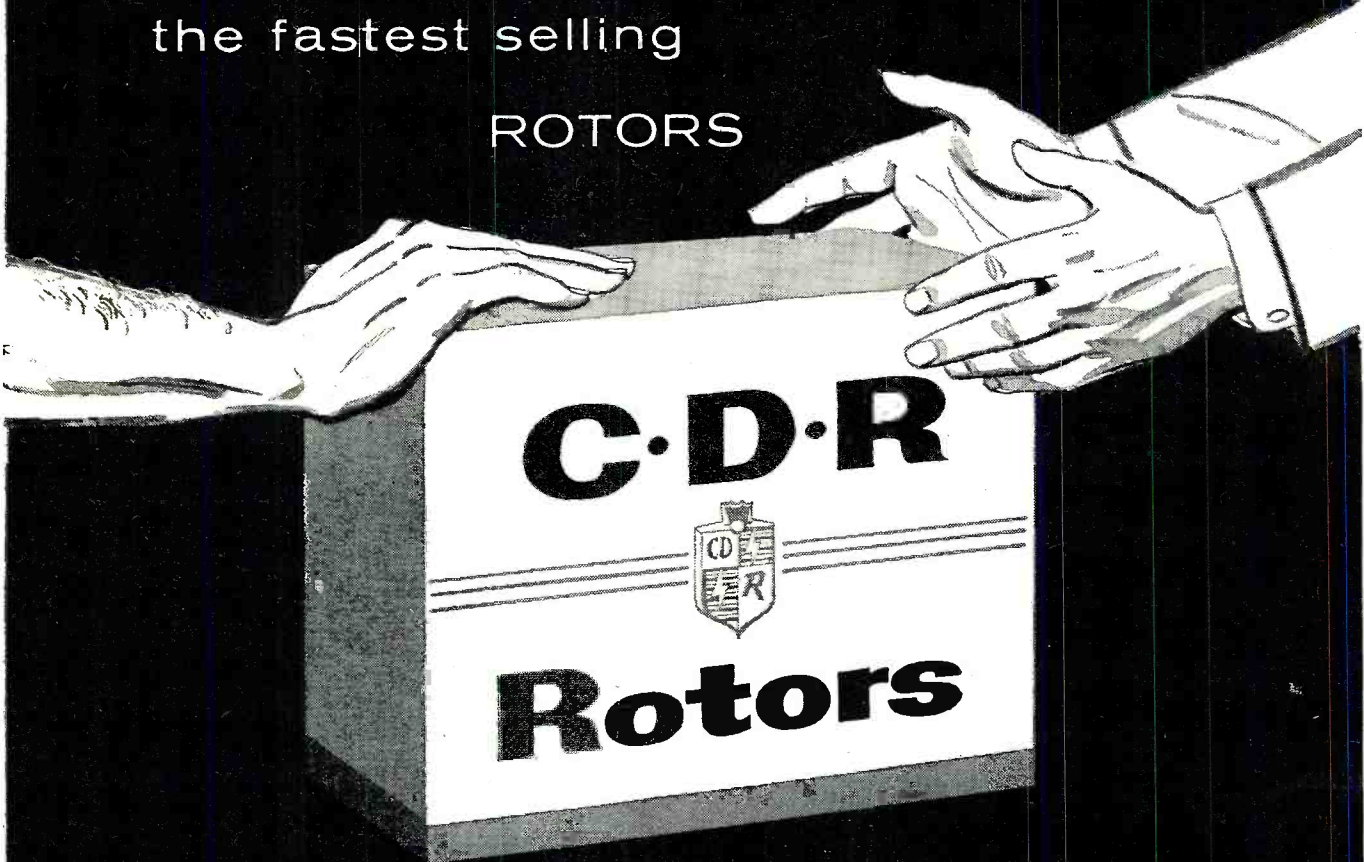

because ...

- ✓ Pre-Sold to millions every week on TV
- ✓ The Most Complete Line ... A Model for Every Need
- ✓ Superior Engineering ... they're Tried-Tested-Proven

<p>AR-22</p>	<p>AR-1</p>	<p>AR-2</p>	<p>TR-2</p>	<p>TR-4</p>	<p>TR-12</p>	<p>TR-11</p>
<p>Completely AUTO-MATIC version of the TR-2 with all the powerful features that made it famous.</p>	<p>Completely AUTO-MATIC rotor, powerful and dependable. Modern design cabinet. 4 wire cable.</p>	<p>Completely AUTO-MATIC rotor with thrust bearing. Handsome cabinet, 4 wire cable.</p>	<p>Heavy-duty rotor with plastic cabinet, "compass control" illuminated perfect pattern dial, 8 wire cable.</p>	<p>Heavy-duty rotor, modern cabinet with METER control dial, 4 wire cable.</p>	<p>Combination value ... complete rotor with thrust bearing. Modern cabinet with meter control dial, uses 4 wire cable.</p>	<p>Ideal budget all-purpose rotor, new modern cabinet featuring meter control dial, 4 wire cable.</p>



CORNELL-DUBILIER
SOUTH PLAINFIELD, N. J.



THE RADIART CORP.
CLEVELAND 13, OHIO

Here's a NEW Way to Reach the Top in TV SERVICING

**All-practice method—
professional techniques,
skills, knowledge of
circuits, etc.**



**Includes 17" picture tube, all other
tubes, components for a TV Receiver,
Scope, Signal Generator, HF Probe.
Low Introductory price under \$200,
on easy terms. Mail Coupon today.**

IF YOU HAVE some Radio or Television experience, or if you know basic Radio-Television principles but lack experience—NRI's new Professional Television Servicing course can train you to go places in TV servicing. This advertisement is your personal invitation to get a free copy of our booklet which describes this training in detail.

LEARN-BY-DOING "ALL THE WAY"

This is 100% learn-by-doing, practical training. We supply all the components, all tubes, including a 17-inch picture tube, and comprehensive manuals covering a thoroughly planned program of practice. You learn how experts diagnose TV receiver defects quickly. You see how various defects affect the performance of a TV receiver—picture and sound; learn to know the causes of defects, accurately, easily, and how to fix them. You do more than just build circuits. You get practice recognizing, isolating, and fixing innumerable TV receiver troubles.

You get actual experience aligning TV receivers, diagnosing the causes of complaints from scope patterns, eliminating interference, using germanium crystals to rectify the TV picture signal, obtaining maximum brightness and definition by properly adjusting the ion trap and centering magnets, etc. There isn't room on this or even several pages of this magazine to list all the servicing experience you get.

UHF AND COLOR TV MAKING NEW BOOM
Installing front-end channel selector strips in modern UHF-VHF Television receivers and learning UHF servicing problems and their solution is part of the practice you get if you live in a UHF area. To cash in on the coming color TV boom you'll need the kind of knowledge and experience which this training gives.

GET DETAILS OF NEW COURSE FREE

Once again—if you want to go places in TV servicing, we invite you to find out what you get, what you practice, what you learn from NRI's new course in Professional Television Servicing. See pictures of equipment supplied, read what you practice. Judge for yourself whether this training will further your ambition to reach the top in TV servicing. We believe it will. We believe many of tomorrow's top TV servicemen will be graduates of this training. Mailing the coupon involves no obligation.

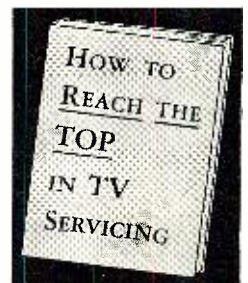

**National Radio Institute, Dept. 6CET
16th and U Sts., N.W., Washington 9, D. C.**

Please send my FREE copy of "How to Reach the Top in TV Servicing." I understand no salesman will call.

Name _____ Age _____

Address _____

City _____ Zone _____ State _____

APPROVED MEMBER NATIONAL HOME STUDY COUNCIL

E-V

**for PA
LIKE ON TV**

**636
Slimair
DYNAMIC
MICROPHONE**

Gives you features similar to those in the famous E-V Slim-Trim TV Microphones. That's why it is so outstanding for Public Address, Recording and other general-purpose use.
List Price \$70

**SMOOTH RESPONSE
60-13,000 CPS
HIGH OUTPUT
OMNIDIRECTIONAL
ACOUSTALLOY
DIAPHRAGM
BUILT-IN
BLAST FILTER**

Can be used
in the hand,
on a stand,
or overhead

SEND FOR BULLETIN

Electro-Voice
410 CARROLL ST. • BUCHANAN, MICH.
Export: 13 E. 40th St., N. Y. 16, U.S.A.

For the RECORD.

BY THE EDITOR

PROGRESS AND THE TECHNICIAN

THIS being our third annual Special Service Feature Issue, devoted mainly to bringing radio, TV, and electronic service technicians exclusive articles on subjects of vital interest to them, it may be appropriate to ask how the servicing profession has advanced itself in three years.

Three years ago the major problems facing the service business were adverse publicity tending to discredit all service dealers, the cut-rate service operator who oftentimes engaged in shady business deals, the threat of the spread of factory service branches, and the indiscriminate selling of electronic parts, by dealers and jobbers, to the public at discount prices. While three years is a relatively short period, some definite gains have been made in coping with these problems but, ironically, new ones have arisen to plague the service dealer.

Actually, no single factor is responsible for the improved standing of the service dealer in the eyes of his customers. There are many things involved: TV set makers, recognizing their responsibility for helping to establish a more responsible element in the service business, publicized the facts regarding the majority of TV service operations in this country. These facts, that, on the whole, charges for service were fair and equitable, that the customer himself invited the "gyp" operator by looking for bargains, that TV sets, no matter how well made, still require service because of their complexity, etc., impressed most of the set-owning public.

Service associations also contributed heavily in this improvement in public relations. Through unified promotions at a local level they helped to better relations between their members and the set-owning public. As the public became aware of the availability of legitimate, fair, well-run service shops, they decreased their patronage of the cut-throat operators. Most set owners now realize that a well-run TV service business must have a realistic minimum charge. Although the cut-throat operator is still in business in many localities, he is no longer the threat he once was.

As for the spread of factory service branches, this trend never really developed. Despite the excellent reputation and business enjoyed by one such factory service group, various factors have deterred other manufacturers from following suit. Many TV manufacturers are still investigating the advisability of opening such branches; however, their final decision will rest on the ability of the independent service industry to handle the more complex work involved in servicing color receivers.

Although some manufacturers have expressed doubts regarding the ability of the independent technician to handle a heavy concentration of color sets, the majority of the set makers feel that they can leave color servicing in the hands of the independents. That this faith does exist is indicated by the huge sums being spent by manufacturers on color TV service courses for the technician. On the whole, this question will probably not be finally decided for a few years or until more color receivers are in the hands of the public.

There are instances where TV service associations have pressured local electronic parts distributors to discontinue selling parts to the public at discount prices. Many view this complaint, however, as exaggerated. They claim that in this "do-it-yourself" age such buying is inevitable. There are many sources for parts at less than the list price and those who are desirous of obtaining such parts will seek them, even at great inconvenience to themselves. It may be that the answer to this problem lies in educating the "fix-it-yourself" segment of the public as to what they legitimately can and cannot do for the good of their sets. This, of course, is a case of "if you can't beat 'em—join 'em."

Of course, there are many new problems which have arisen to harass the service dealer—the drugstore tube checker, color TV, and transistor radios, for example. But there is no reason to expect that all of these things will not be successfully coped with by our dynamic new service industry. O. R.

free

ALLIED'S 1956 value-packed 324-PAGE CATALOG

the only **COMPLETE** catalog for everything in TV, Radio, Hi-Fi and Industrial Electronics

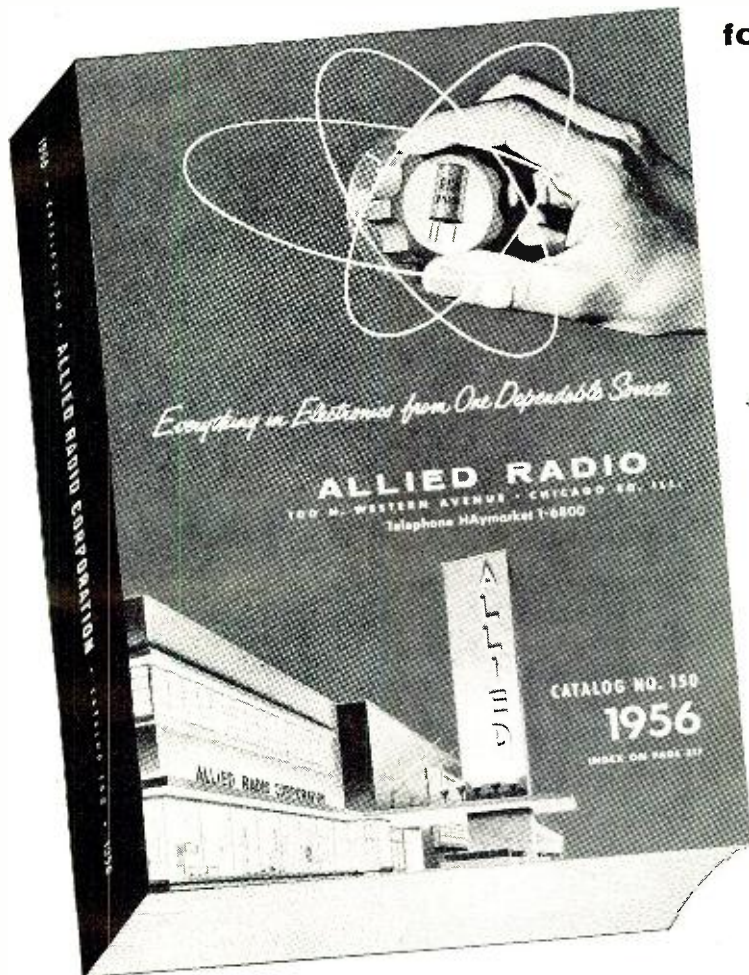

Get ALLIED's 1956 Catalog—it's *complete*, up-to-date—324 pages packed with the world's largest selection of quality electronic equipment at lowest, money-saving prices. Get *every* buying advantage at ALLIED: fastest shipment, expert personal help, lowest prices, assured satisfaction. Send today for your **FREE** copy of the big 1956 ALLIED Catalog.

World's Most Complete Stocks

- Latest Hi-Fi Systems and Components
- P.A. Systems and Accessories
- Recorders and Supplies • TV Tubes, Antennas, Accessories • Amateur Receivers, Transmitters, Station Gear
- Specialized Industrial Electronic Equipment • Test and Lab Instruments
- Huge Listings of Parts, Tubes, Transistors, Tools, Books

Featuring Super-Value Knight-Kits—top quality electronic equipment in precision-designed kit form
BUY DIRECT AND SAVE

EASY-PAY TERMS

Use our liberal Easy Payment Plan—only 10% down, 12 months to pay—no carrying charges if you pay in 60 days. Available on Hi-Fi and P.A. units, recorders, TV chassis, test instruments, kits, Amateur gear, etc.

HI-FI SPECIALISTS

To keep up with the latest and best in High Fidelity, look to ALLIED. Count on us for *all* the latest releases and largest stocks of Hi-Fi equipment. We specialize, too, in TV supply—and are foremost in the field of Builders' Kits.



send for the leading electronic supply guide

ALLIED RADIO CORP., Dept. 1-C-6
100 N. Western Ave., Chicago 80, Ill.

Send FREE 324-Page 1956 ALLIED Catalog.

Name _____

Address _____

City _____ Zone _____ State _____



ALLIED RADIO

World's Largest Electronic Supply House

March, 1956

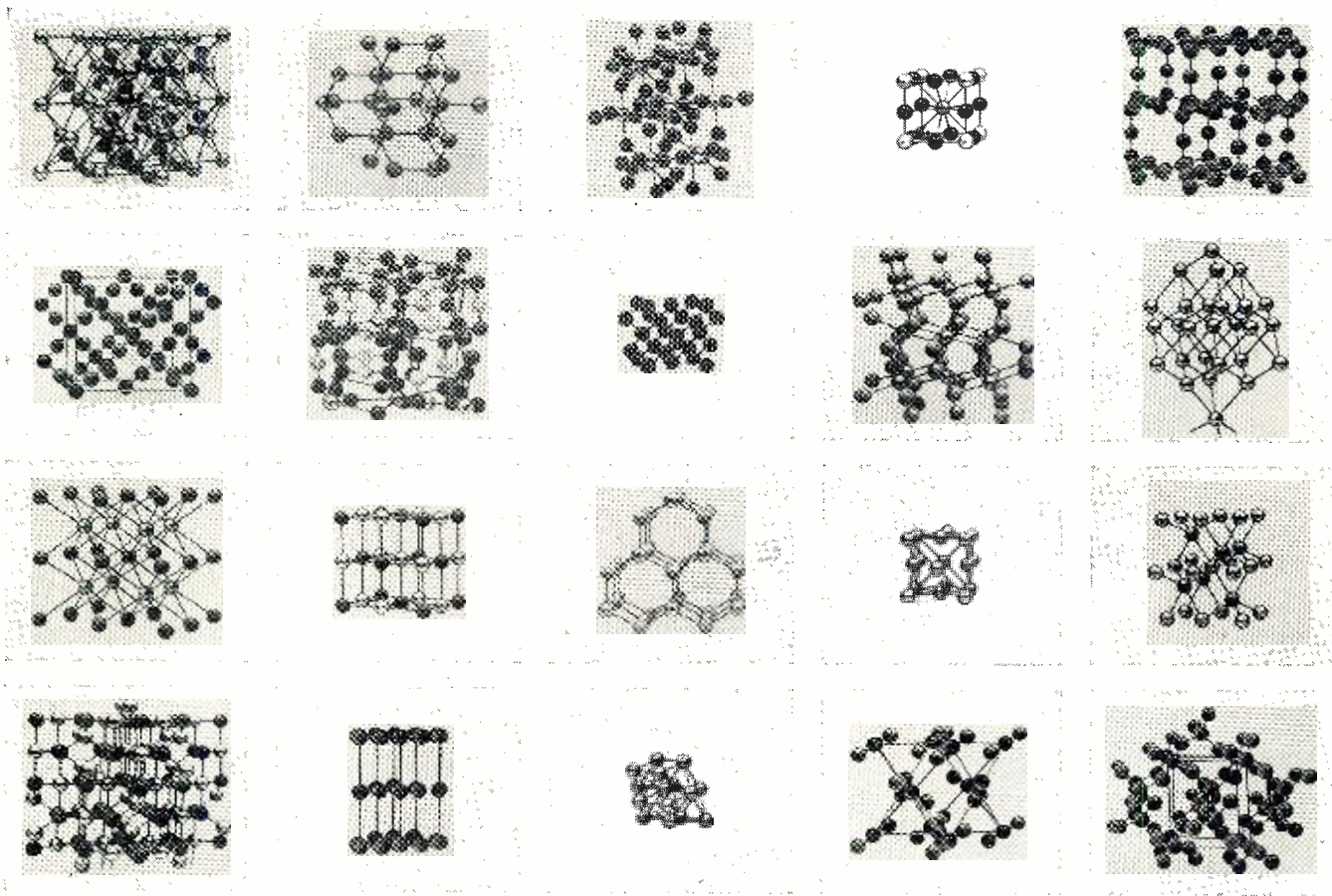

Crystal structure models. Top row, left to right: cuprite, zincblende, rutile, perovskite, tridymite. Second row: cristobalite, potassium dihydrogen phosphate, diamond, pyrites, arsenic. Third row: caesium chloride, sodium chloride, wurtzite, copper, niccolite. Fourth row: spinel, graphite, beryllium, carbon dioxide, alpha-quartz.

FROM ATOMS TO STARS

Research at Bell Telephone Laboratories ranges from the ultimate structure of solids to the radio signals from outer space. Radio interference research created the new science of radio astronomy; research in solids produced the transistor and the Bell Solar Battery.

Between atoms and stars lie great areas of effort and achievement in physics, electronics, metallurgy, chemistry and biology. Mechanical engineers visualize and design new devices. Mathematicians foreshadow new communications techniques.

Despite the diversity of their talents, Bell Laboratories scientists and engineers have much in common. A habit of teamwork channels these talents into great communications advances. These men have developed



Models of the atomic patterns in solids help Bell Laboratories scientists visualize their electrical behavior.

the world's finest telephone system. In doing so, many have become leaders in their fields. Opportunities for achievement await properly qualified scientists and engineers at Bell Telephone Laboratories.



Directional antenna used by Karl G. Jansky in discovery of stellar radio signals at Bell Telephone Laboratories in 1932.

BELL TELEPHONE LABORATORIES



WORLD CENTER OF COMMUNICATIONS RESEARCH • LARGEST INDUSTRIAL LABORATORY IN THE UNITED STATES

A REVOLUTIONARY IDEA

"...the greatest thing that has happened for music-lovers since the introduction of long-playing records"—DEEMS TAYLOR



★ YOU GET A 12-INCH 33 1/3 R.P.M. RECORDING OF A GREAT WORK OF MUSIC WITH AN OUTSTANDING ARTIST, ORCHESTRA OR CONDUCTOR...



★ ALWAYS ACCOMPANIED—AT NO EXTRA CHARGE—BY MUSICAL PROGRAM NOTES—THAT IS, A 10-INCH RECORD OF COMMENTARY, FULL OF MUSICAL ILLUSTRATIONS, TO ENHANCE YOUR ENJOYMENT AND UNDERSTANDING OF THE WORK

Music Appreciation Records

THIS new idea, originated a year ago by the Book-of-the-Month Club, has a twofold purpose: first, to help you build, systematically, a representative collection of recorded music—all the great works which are recognized as being necessities in every "basic" record library; and second, to enable music-lovers (particularly where there are young persons in the family) to increase their enjoyment and understanding of these masterpieces—and, indeed, all the music they hear.

HEART OF THE IDEA — MUSICAL ILLUSTRATIONS—The ten-inch recording sensibly takes the place of the time-honored printed "program notes"—almost necessarily inadequate, and usually impossible to follow by persons who have had no formal musical training. By contrast, this new idea now enables the writer of program notes to show you, by having a full orchestra demonstrate the main features of the

work, what to listen for in order to get the maximum enjoyment.

EVERY MONTH a great work of recorded music, featuring some of the world's most distinguished musicians, is announced and described in advance. You let it come, if you want it. If not, you can reject it by sending in an instruction form, always provided. When you decide you want the work described, the 12-inch Performance Record and the 10-inch Musical Program Notes are shipped together at a combined price of \$3.90, plus a small charge for mailing expenses.

A DEMONSTRATION OFFER—The two records by Leonard Bernstein described at the right will be sent you at once—without charge—if you enroll now in a trial subscription, and agree to buy only two other MUSIC-APPRECIATION selections during the next year, from among at least fifteen that will be made available.

FOR EXAMPLE

LEONARD
BERNSTEIN

conducts

DVORAK'S

New World Symphony

AND ALSO PROVIDES THE
MUSICAL PROGRAM NOTES



BOTH RECORDS

Given to you

IN A TRIAL SUBSCRIPTION

—if you agree to buy two other Music-Appreciation selections during the next year

PLEASE RETURN ONLY IF YOU HAVE A 33 1/3 R.P.M. RECORD PLAYER

MUSIC-APPRECIATION RECORDS R38-3
c/o Book-of-the-Month Club, Inc.
345 Hudson Street, New York 14, N. Y.

Please enroll me as a subscriber to MUSIC-APPRECIATION RECORDS and send me, without charge, the 12-inch 33 1/3 R.P.M. Demonstration Record of Dvorak's *New World Symphony* conducted by Leonard Bernstein, together with the 10-inch Musical Program Notes Record written and also conducted by Mr. Bernstein. I agree to buy two MUSIC-APPRECIATION selections during the next year, and I have the right to cancel my subscription any time after buying two selections.

Mr. }
Mrs. }
Miss } (PLEASE PRINT)

ADDRESS.....

CITY..... Postal Zone No. STATE.....
(if any)

MAR 67

**MR. SERVICE DEALER! INVEST IN...
YOUR FUTURE IN COLOR TV SERVICE
AND EQUIP YOUR SHOP *FREE!***

DURING THE FABULOUS
PHILCO
SHARE *and* PROFIT
DIVIDEND OPPORTUNITY



That's right! This is the year to equip for color and by concentrating your radio and TV Parts and Accessory purchases on Philco, you can earn FREE Philco color and B/W Test Equipment and Parts and Accessory Dividends . . . all at no extra cost! SHARE and PROFIT dividends go to work for you immediately . . . building EXTRA 100% profits because they cost you nothing. Sell them for full profit or put them to work in your own shop. Make your business prosper like never before! Now is the time to equip yourself for color servicing . . . FREE. See your Philco Distributor for details.

NO LIMIT TO WHAT YOU CAN EARN

Order your Parts and Accessories, then pick the dividends you need. Stock up on genuine Philco Parts and Accessories and earn the dividends of your choice through valuable SHARE and PROFIT stamps you receive with each purchase. SHARE and PROFIT stamps are redeemable at your Philco Distributor's for the dividends of your choice.

**PHILCO PUTS YOU IN THE COLOR
SERVICE BUSINESS WITH ONE COMPACT INSTRUMENT**
**PHILCO UNIVERSAL COLOR BAR AND
DOT BAR GENERATOR Model 7100**

It's new . . . highly efficient . . . designed to provide the widest possible variety of functions in the minimum amount of space. PHILCO MODEL 7100 can be used to completely trouble-shoot circuits associated with

color reproduction and make accurate convergence adjustments in any color receiver made. In conjunction with your present monochrome equipment, it gives you complete color service facilities!

PLUS OTHER VALUABLE *FREE* DIVIDENDS LIKE THESE

- Store Aids and Fixtures
- Dealer Store Identification Signs
- Your Choice of Parts and Accessories
- 6 HP Lauson Outboard Motor

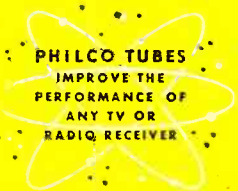

PHILCO CORPORATION
ACCESSORY DIVISION PHILADELPHIA 34, PA.



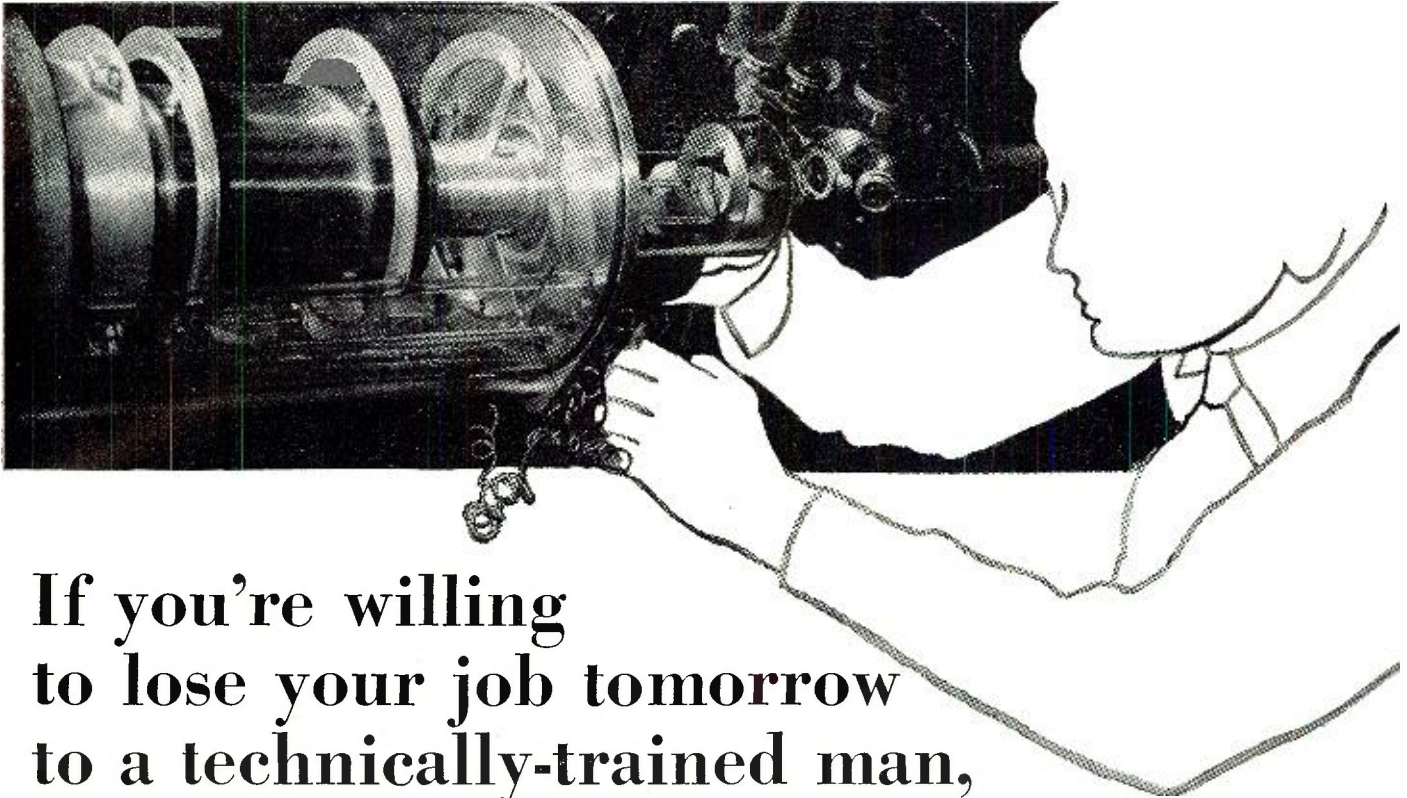

If you're willing to lose your job tomorrow to a technically-trained man, *turn the page, mister*

But, if you're interested in an honest-to-goodness career in the vigorous young electronics industry, here's how you can step ahead of competition, move up to a better job, earn more money, and be sure of holding your technical job even if the brass is firing instead of hiring.

The "how" is CREI training in radio-television-electronics. You don't have to be a college graduate. You *do* have to be willing to study—at home. You can do it while holding down a full-time job. Thousands have. However, you must have some prior electronic experience, either in military service, professional employment, experimenting, or ham operating. Since 1927 CREI has provided alert young men with the technical knowledge that leads to more responsibility, more job security, more money. More than a quarter century of experience qualifies CREI to train you.

What qualifies *you* for CREI? If you have a high school education, you're off to a good start. If you have a knack for math, so much the better. If you are currently working in some phase of the electronics industry, you'll get going faster. But remember this: CREI starts with fundamentals and takes you along at your own speed. You are not held back by a class, not pushed to keep up with others who have more experience or education. You set your own pace. Your CREI instructors guide you through the lesson material and *grade* your written work personally. You master the fundamentals, then get into more advanced phases of electronics engineering principles and practice. Finally you may elect training at career level in highly specialized applications of radio or television engineering or aeronautical radio.

How good is CREI training? Here are a few ways to judge. Ask an electronics engineer, if you know one.

Ask a high-school or college physics teacher. Ask a radio station engineer. Check up on our professional reputation: CREI home study courses are accredited by the Engineers' Council for Professional Development; CREI is an approved member of the National Council of Technical Schools. Ask personnel managers how they regard a man with a CREI "ticket." Look at this partial listing of organizations *that pay CREI* to train their own personnel: All American Cables & Radio, Inc.; Canadian Aviation Electronics, Ltd.; Canadian Broadcasting Corporation; Columbia Broadcasting System; Hoffinan Radio Corp.; Machlett Labs.; Glenn L. Martin Co.; Magnavox Co.; Pan American Airways, Atlantic Division; Radio Corporation of America; United Air Lines. Finally, ask a CREI graduate to tell you about our Placement Bureau, which currently has on file more requests for trained men than we can fill.

What's the next step? The logical one is to get more information than we can cram into one page. The coupon below, properly filled out, will bring you a fact-packed booklet called "Your Future in the New World of Electronics." It includes outlines of courses offered, a resume of career opportunities, full details about the school, and tuition details. It's free.

Note: CREI also offers Residence School instruction, day or evening, in Washington, D.C. New classes start frequently. If you are a veteran discharged after June 27, 1950, let the new GI Bill help you obtain resident instruction. Check the coupon for more data.

CAPITOL RADIO ENGINEERING INSTITUTE
Accredited Technical Institute Curricula • Founded 1927
3224 16th St., N. W., Dept. 113-C, Washington 10, D. C.

Please send me your course outline and **FREE** illustrated Booklet "Your Future in the New World of Electronics" . . . describing opportunities and CREI home study courses in Practical Electronics Engineering.

CHECK FIELD OF GREATEST INTEREST

Practical Radio Electronics Engineering
 Broadcast Radio Engineering (AM, FM, TV)
 Practical Television Engineering
 Practical Aeronautical Electronics Engineering

To help us answer your request intelligently, please give the following information:

EMPLOYED BY

I **TYPE OF PRESENT WORK**

SCHOOL BACKGROUND

ELECTRONICS EXPERIENCE

Name.....
Street.....
City..... Zone..... State.....

CHECK: Home Study Residence School Veteran

Dealers by the thousands are
making the **SWITCH**

to this great insulator idea!



when we say

SWITCH

WE MEAN

business!

New indoor antenna has

gliding

SWITCH

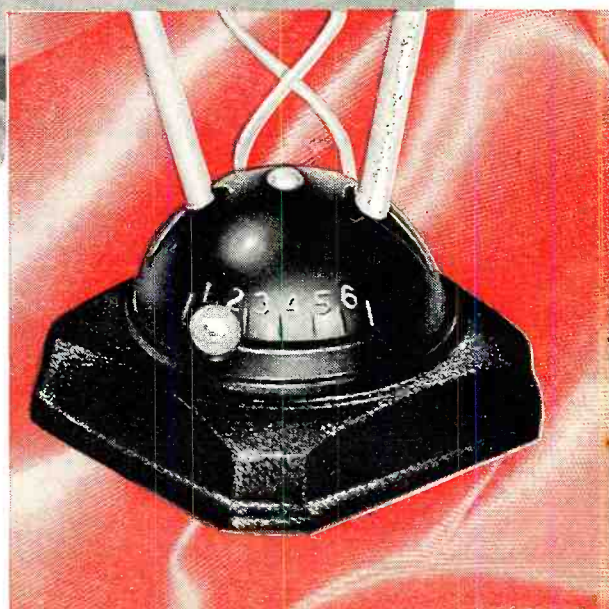

Only **CHANNEL MASTER**®

Millions already sold!
Here's why:

STANDOUT

insulators

have this revolutionary
2 in 1 design

It's a wood-screw insulator

... it's a machine-screw insulator

*... and it's **BETTER** in both applications!*

STANDOUT insulators and buckles are already outselling all others — *after only a few months on the market!* This remarkable record provides positive proof of the solid acceptance STANDOUTs have won among dealers all over the country.

Why has the response to STANDOUTs been so enthusiastic? **BECAUSE** they cut space and dollar investments in accessories by more than 65% . . . **BECAUSE** they increase space and dollar turnover by more than 200% . . . **BECAUSE** they are easier to install, stronger, more durable.

"T-Nut" buckle with 8 threads.

More threads than any other buckle (nut type or extruded) — 8 full machined threads! Tighten as hard as you want, you can't strip it!



Pointed Screw makes positive contact.

Strap won't slip while you're tightening. Won't twist or slip on mast after installation. Straps have convenient "taper-tip."



Needle-sharp point

Finer thread, sharper point means easier starting — even in hardwood. Minimizes possibility of splitting.

Ordinary standoff point.



STANDOUT point.

All popular types and sizes available, including full assortment of specialized hardware. See your Channel Master distributor

CHANNEL MASTER'S

new **Glide-o-Matic**

INDOOR TV ANTENNA

The Glide-o-Matic's sensational low-loss **gliding switch** is different from all others! Provides highest electrical efficiency . . . **AND** — it's the most convenient to operate!

Glide-o-Matic also gives you:

- Maximum performance on all channels — VHF and UHF.
- Weighted tip-proof base — with "can't scratch" felt covering.
- Ready for COLOR TV.
- Powerful retail merchandising support.

Available in
4
popular color
harmonies:

Mahogany	with brass	model no. 3700
Ebony	with brass	model no. 3701
Ivory	with brass	model no. 3702
Ebony	with aluminum	model no. 3703

A performance hit with men...

A style hit with women!

Glide-o-Matic practically sells itself. Smartly styled . . . blends into any setting. Packed in colorful "tell and sell" carton with convenient "carry away" handle.



\$9.95
list

Also available:

CHANNEL MASTER'S ALL-VU
model no. **381**, all-VHF, all UHF.

\$8⁹⁵
list



CHANNEL MASTER'S PRE-VU
model no. **380** all-channel VHF.

\$7⁹⁵
list



CHANNEL MASTER CORP.
ELLENVILLE, N. Y.

WORLD'S LARGEST MANUFACTURER OF TV ANTENNAS AND ACCESSORIES

The
Microphone
makes the
difference...

between an ordinary
performance and a
truly fine distortion-
free recording.

Your tape recording or PA
equipment can reproduce a
much wider range of voice
or music—if you use these

SHURE microphones!



"SONODYNE" Model 51

A dynamic semi-directional microphone with excellent response to 10,000 cps. Widely used by performers, bands and recording artists. Ideal as a moderate-cost replacement for conventional tape recorder and PA microphones. Multi-impedance switch gives you the versatility of three microphones in one. Supplied with 15' microphone cable. Rich satin chrome finish. List price \$49.50.



"MONOPLEX" Model 737A

The only uni-directional crystal microphone made! Super-cardioid polar pattern reduces pickup of background noises and reverberation by 73% to provide clear noise-free recordings. Frequency response to 10,000 cps. Has moisture-proofed "Metal Seal" crystal and internal sponge-rubber floating mount for long operating life. 15' cable, satin chrome finish. List price \$46.00.



The Mark of Quality

SHURE BROTHERS, INC.

225 West Huron Street, Chicago 10, Illinois

Spot Radio News

★ Presenting latest information on the Radio Industry.

By RADIO & TELEVISION NEWS'
WASHINGTON EDITOR

THE SIGNIFICANT DEVELOPMENTS in the field of electronics, which revolutionized radio, TV, wire and cable operation during '55, were dramatically reviewed in a year-end statement by FCC's chairman, George C. McConaughy, and quoted as having spurred sight and sound activity to a new high.

As the Commission closed its books for the year, it was disclosed, more than 1,400,000 radio authorizations had been approved. These represented some 60 different kinds of radio services on land, sea, and in the air. And they involved the use of over 800,000 fixed and mobile transmitters, and over 1,100,000 permits, of different grades, to operate them.

Today, said the Commissioner, American homes, served by over 4000 TV, AM, and FM stations, have more radios and TV sets than bathtubs, running water, or refrigerators. The AM broadcast service, it was revealed, has grown to nearly 3000 stations, with over 2800 now in operation. And on the TV scene, there are almost 500 stations on the air; there is at least one TV station in each of more than 250 communities, and 100 other communities have two or more TV outlets.

As for the common carrier services, the Commission's spokesman said, people talk more over the telephone than ever before. Nearly 200-million calls are now handled daily by 54-million telephones. And telephone circuits now use more microwave and coax cable links than ever. The records showed that more than a million messages went over radiotelephone connections between this country and a hundred overseas points.

Commenting on the future, McConaughy said that radio and TV will continue to expand and give more enjoyment, information, and cultural education to the American people. In '56, he felt that radio and TV will play a particularly important role in the national elections.

Shortly before the release of the report for the year, the Commission's headman issued an enthusiastic statement on the prospects for color, during a talk before the Poor Richard Club in Philadelphia. In his opinion, color will be "very commonplace in the next 16 to 18 months."

A NUMBER OF INTRIGUING facts, spelling out industry progress, also ap-

peared in FCC's annual "best-seller," the official yearly report to Congress.

The review, the 21st, filed in a 168-page book, noted that Texas continued to lead all states in the total number of broadcast authorizations. In mid-June, when the fiscal tabulations were made, Texas had 277 AM, FM, and TV authorizations, collectively. California came second with 241, and Pennsylvania third with 221.

In the AM listing, Texas was also at the top with 212 authorizations, followed in turn by California with 155, Pennsylvania with 133, North Carolina with 124, New York with 110, and Florida with 109. The FM commercial list was headed by Pennsylvania with 44, followed by New York with 43, and California with 39. Citywise, New York led the commercial FM field with 11, followed by Chicago with 10, Washington 8, and Cleveland, Detroit, Los Angeles and Philadelphia with seven each.

The subject of interference was deemed to be so vital that a whole section was devoted to it in the annual report. This was necessary, it was said, because interference has become one of the most vexing problems confronting communications today. It affects all types of services and involves consideration of a growing number of electronic devices and gadgets.

With some 800,000 authorized transmitters, it is difficult enough, it was emphasized, to see to it that radio transmissions do not collide with each other. But this engineering task is magnified by the accidental or careless release of emissions by apparatus using radio-frequency energy for various noncommunication purposes.

Offending unlicensed equipment, it was shown, falls into two general groups. One such group embraces industrial, scientific, and medical equipment, typified by industrial heaters, diathermy machines, arc welders, and similar items. The second group covers restricted radiation devices, such as carrier current (wired) communication systems, also remote-control operation of garage doors, phono record players, and so on.

Causes of interference have been found to vary. The records show the following to be sources of trouble: defective or obsolete light bulbs or radio tubes; defective interior or exterior electric circuits; broken wires and in-

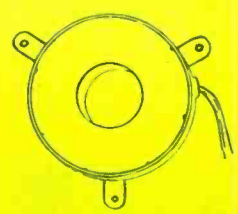
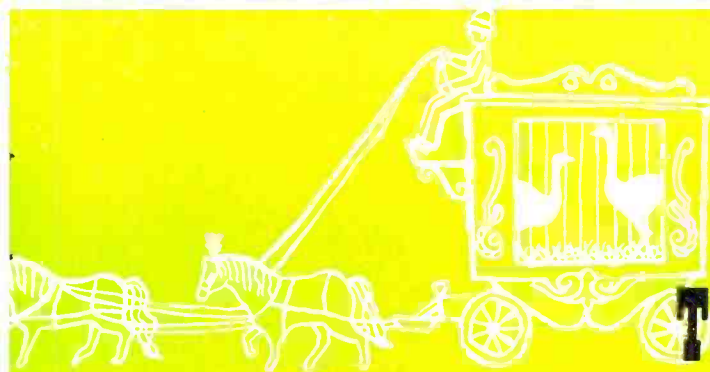

THE MERIT PARADE... '55-'56

We're beating our biggest drum... the spectacular parade of new items—over 100 in 1955—will go on! Constant engineering and research will continue to keep Merit the most complete replacement line in the field in 1956.



Truly under the big top... Merit is the only manufacturer of transformers, yokes and coils who has complete production facilities for all parts sold under their brand name.



Merit...FIRST IN REPLACEMENT TRANSFORMERS

Merit Coil & Transformer Company
4427 North Clark Street, Chicago 40, Illinois

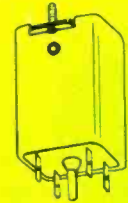
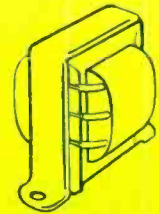
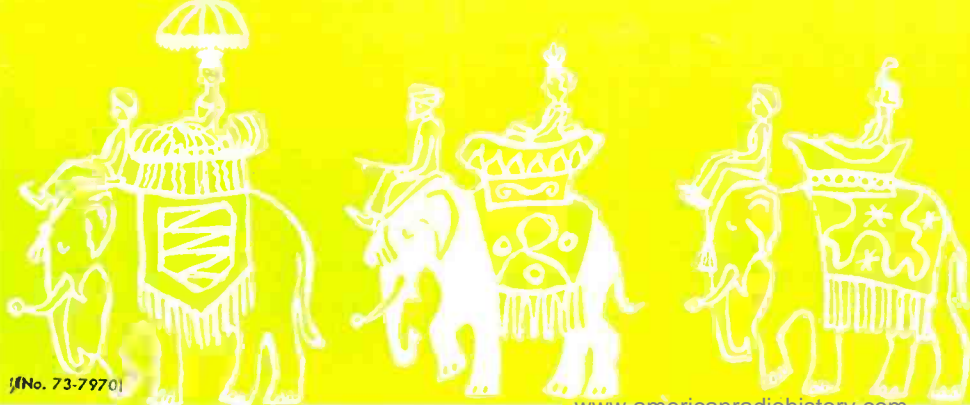
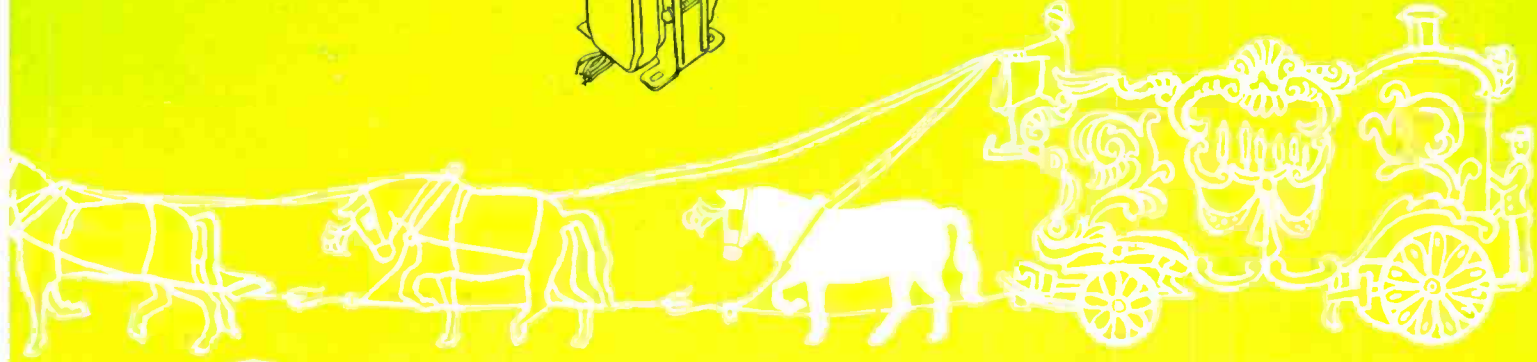
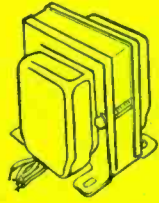
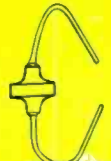

(No. 73-7970)

HICKOK



This unit features another HICKOK FIRST—A Non-Parallax shadow type dial provides a 300% magnification of scale, permitting exact settings for most accurate readings, and can be viewed from any angle without error.

**300%
MAGNIFICATION**

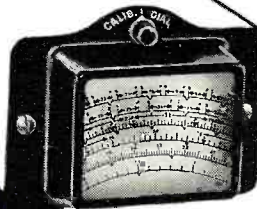

This entirely new and advanced equipment represents the latest HICKOK achievement in offering complete, fast and accurate solution to TV alignment.

**MODEL 690
VHF - UHF MARKER GENERATOR:**

Has crystal controlled frequency coverage from 4.25 to 225 MC, all on fundamentals. Provides dual markers with any TV Sweep Generator. The 45 inches of dial can easily be self-calibrated to within crystal accuracy (.05%). Features picture and sound frequencies directly calibrated on the dial. There is no counting of beats—no interpolation—no remembering of frequencies. Has complete RF coverage up through channel 83. Through use of the 690 it is now possible to view two markers at once on the response curve.

MOST ADVANCED TV Alignment Equipment

For Black & White or Color

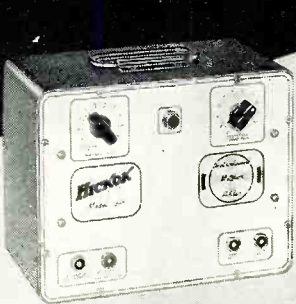

**MODEL 691
HETERODYNED MARKER ADDER:**

This unit heterodynes the outputs of the 690 and 695 so as to prevent overloading. The 691 provides a marker visible at all times (including trap points) and will not change in amplitude or distort the response curve.



**MODEL 695
SWEEP GENERATOR:**

A completely new All-Electronic Sweep Generator. There are no moving parts to produce vibration or to wear out. This unit features a sweep signal that is absolutely linear and without amplitude modulations.

The 695 is triple shielded to insure minimum leakage. Signal can be attenuated to 3 microvolts. Bias voltage is variable from 0 to 12 volts. Extra strong signal permits accurate front-end alignment.

Ask Your Parts Jobber For A Demonstration Today!

THE HICKOK ELECTRICAL INSTRUMENT COMPANY

10524 Dupont Avenue • Cleveland 8, Ohio

ulators; oscillating AM or FM receivers; inadequately-shielded or improperly-installed or adjusted TV sets; radio equipment inadvertently left on; defective antenna systems; homemade record players; electric fences; home and factory heating equipment; college campus broadcast systems; community antenna systems; electric signs, razors, heating pads, thermostats, and other household equipment; interference effects of passing planes, automobiles, street-cars, and buses; draw bridges; faulty transformers and insulators; and weather disturbances.

AN OFFICE OF Naval Research contractor, the Physics Department of Linfield College, McMinnville, Oregon, has developed a new electronic device, a megawatt field-emission cathode, which it is believed may lead to new advancements in flash x-ray photography and the generation of electromagnetic waves shorter than those now in common use.

Under the direction of Dr. W. P. Dyke, director of research at the college, lab scientists have applied voltage to release a flood of electrons from the cathode, with no heat required. In a vacuum tube, electrons are usually produced by heating a metal filament.

The field emitter, it was said, is a tiny tungsten needle, less than one-tenthousandth of an inch in diameter; it can be seen clearly only with an electron microscope. Despite its smallness, the needle's electron supply has been found to be so sensitive to the applied voltage, that currents of several amperes have been drawn from one needle; enough to operate an electric toaster.

When several emitters are mounted in a comb-like array, and operated in parallel, currents up to 20 amperes at a peak power of more than a million watts have been obtained. This is more power than most TV and radio stations supply.

Since at present tubes are not a primary source of power, but only transform energy from one form to another, Linfield scientists believe that further research on field emission may result in even greater power.

A STABLE TYPE OF radio-frequency voltmeter, known as an attenuator-thermo-element or AT voltmeter, has been designed by specialists of the Bureau of Standards. Unlike instruments now available, these voltmeters are said to maintain a calibration stability well within the accuracy of the original calibration—about one percent over most voltage and frequency ranges—for a year or longer.

The voltmeters can be used to measure r.f. voltages from .1 to several hundred volts at frequencies up to about 1000 megacycles. Although r.f. voltages within this range can be accurately measured and standardized by other means, it has been found difficult to find voltage-measuring instruments that can hold their calibration
(Continued on page 181)

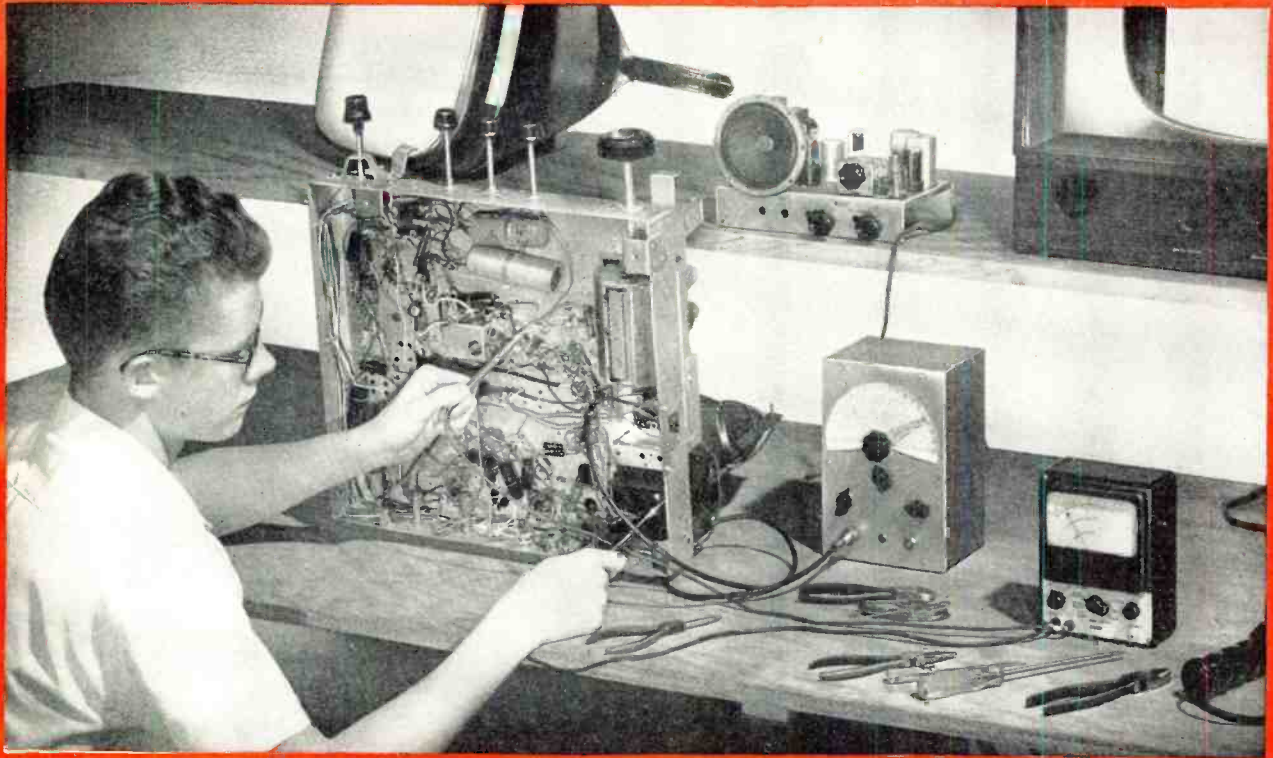

NOW... RCA trains you at home to be an expert technician in...

RADIO-TV ELECTRONICS

TV SERVICING

COLOR TV SERVICING

NOW THREE HOME STUDY COURSES... prepared by instructors of RCA Institutes, engineers from RCA Laboratories, and training experts of the RCA Service Company. Clearly written... easy to understand... the same high caliber instruction as given in the resident classrooms of RCA INSTITUTES.

● **COURSE I—RADIO-TELEVISION ELECTRONICS**—starts you from the ground up to a solid working knowledge of electronics. Without any previous experience, you get a thorough training in radio theory and servicing techniques for AM, FM, home and car radios... plus an introduction to the fundamental theory and practices of television.

● **COURSE II—TELEVISION SERVICING**—prepares you to advance from radio into the expanding field of television servicing as a well-trained service technician. If you have completed Course I or are now working in

the field of radio or TV, Course II will show you the many special techniques of troubleshooting, aligning, checking, and repairing modern black and white TV sets.

● **NEW TV KIT AVAILABLE WITH COURSE II**—there is no better way to learn than by *doing* and RCA Institutes has developed a large-screen TV KIT available to home study students to build while taking Course II. It has the most modern up-to-date circuitry, actually enabling you to apply at home all the latest servicing techniques.

● **COURSE III—COLOR TELEVISION SERVICING**—covers all phases of color servicing techniques. It is a practical, down-to-earth course in color theory as well as how-to-do-it servicing procedure. A natural move "up" from Course II or for those now employed in TV.

SINCE 1909, RCA INSTITUTES has trained thousands for successful careers in elec-

tronics. Many graduates have established their own paying business. Now this opportunity is available to you at home.

"PAY-AS-YOU-LEARN" PLAN... you pay for one study group at a time, as you progress through the course. Tuition costs are amazingly low. For full details, mail coupon.

A SERVICE OF RADIO CORPORATION OF AMERICA—RCA INSTITUTES is licensed by the N. Y. State Education Department... recommended by radio and television service organizations.

**SEND FOR
FREE
CATALOG
NOW**

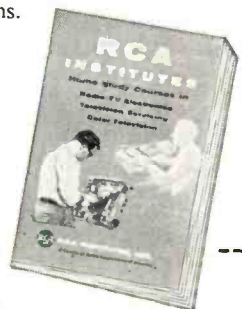

RCA INSTITUTES, INC.

A SERVICE OF RADIO CORPORATION OF AMERICA
350 WEST FOURTH STREET, NEW YORK 14, N.Y.

RCA Institutes, Inc., Home Study Dept. N-36
350 West Fourth Street, New York 14, N. Y.

Without obligation, send me FREE CATALOG on Home Study Courses in Radio, TV and Electronics. No salesman will call.

Name _____ Please Print

Address _____

City _____ Zone _____ State _____

where do you find

PYRAMID

CAPACITORS AND SELENIUM RECTIFIERS

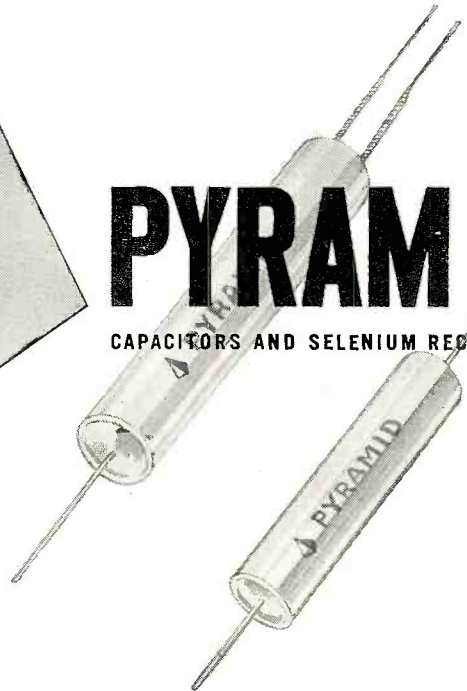
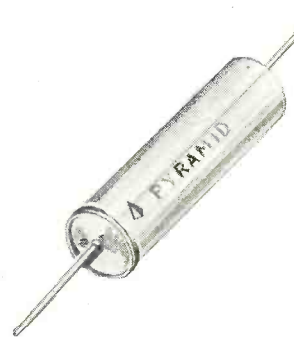
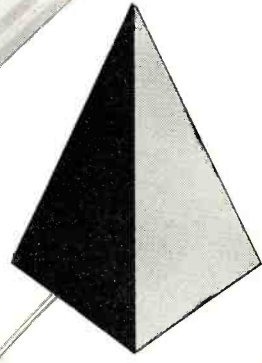

In the electronic products of all these leading brand manufacturers—where their presence testifies to PYRAMID'S high standards of quality and service.

Admiral **Magnavox**



Motorola

CROSLEY

Packard-Bell

DU MONT

RAYTHEON

Emerson



SYLVANIA

hallicrafters

Westinghouse

Hoffman

ZENITH

AND you find PYRAMID as a participant in Howard Sams PHOTOFACT—the bible of radio-television-sound field servicing—which guarantees accurate replacement with PYRAMID parts and testifies to the immediate availability of PYRAMID Capacitors and rectifiers throughout the country.

Howard W. Sams

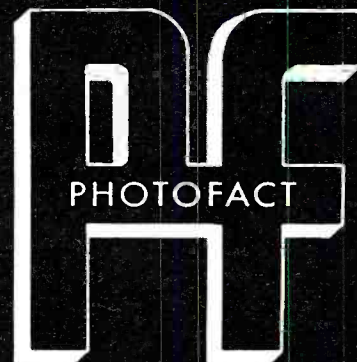

PYRAMID ELECTRIC CO.
North Bergen, New Jersey

THE BIG NAME IN CAPACITORS AND SELENIUM RECTIFIERS TODAY...

COME SEE US AT THE I. R. E. SHOW—BOOTH 586

“This portion of the Garry Moore Show is brought to you *in behalf of radio and television service-dealers* who use and recommend CBS Tubes.

“That’s the way you’re introduced. Later, I focus right on you — like this:

“... television sets require trained service-dealers to keep them in good condition. And believe me, a qualified service-dealer *is a trained technician*. He has spent a lot of time and effort studying electronics, and a substantial amount of money for technical equipment.”

Garry Moore sells your service

while he sells
CBS Tubes*



Garry
Moore
famous CBS
Television Star

“See how CBS-HYTRON works side by side with you. The easy way for you to cash in is to use and recommend CBS Tubes. Because I keep reminding my listeners there are no better tubes made than CBS Tubes — and they have the Good Housekeeping Guaranty Seal.”

You’ll build profitable customer confidence and sales when you recommend CBS Tubes . . . the tubes with the Good Housekeeping Guaranty Seal.



*On the CBS Television Network.

CBS-HYTRON, Danvers, Massachusetts . . . A DIVISION OF COLUMBIA BROADCASTING SYSTEM, INC.

March, 1956

.. INDEPENDENT SCIENTIFIC SURVEY

PRECISE MODEL #111 PROVED

"BEST COMMERCIAL TUBE TESTER

AT ANY PRICE" IN INDEPENDENT SURVEY



precise

Model #111

MUTUAL CONDUCTANCE AND EMISSION TUBE TESTER

An independent scientific survey conducted by an impartial testing laboratory confirms what purchasers already know: "The most advanced, the most complete tube tester and the best priced is made by PRECISE DEVELOPMENT CORP., Oceanside, N. Y."

NOW YOU CAN CHECK TUBES THE MANUFACTURER'S WAY

- Checks both emission and mutual conductance
- Checks all tubes including hearing aid, miniatures
- Six different plate voltages
- Different grid signals
- Simplified Short check
- Gas check
- New type switches
- Deeply etched aluminum panel
- Three different screen voltages
- Latest roll chart
- Measures filament current
- Measures grid bias

111K (kit form)
NOW ONLY

\$69⁹⁵

111W (factory wired) \$139.95

SEE US AT THE IRE SHOW

Prices slightly higher in the West. Prices and specifications subject to change without notice.

CHECK THESE ADDITIONAL 'specs' . . . TALK TO YOUR JOBBER AND TO ANYONE WHO HAS THIS OUTSTANDING TUBE TESTER . . .

The Model 111 is the only single commercial tube tester that checks all tubes for both EMISSION and MUTUAL CONDUCTANCE separately. Filament current is measured directly on large meter when checking a VOLTAGE SAPPER tube. NEW, MODERN DESIGNED ROTARY SWITCHES allow you to check each tube element individually NEW TYPE Single Rotary switch for complete short checks. The 111 makes all BIAS,

FILAMENT VOLTAGE, GAS, LIFE checks visually on large meter . . . 5 individually calibrated ranges and scales for mutual conductance tests. NEWLY DESIGNED "NO BACKLASH" ROLL CHART lists all tubes including the new type 600 mil series tubes. Provisions are made for testing many color tubes. All CRT's can be checked with accessory adaptor, Model PTA.

SEE THE MANY MORE PRECISE INSTRUMENTS AND PROBES AT YOUR JOBBER TODAY!

WRITE FOR CATALOG RN 3-6

precise THE FINEST KIT AND WIRED TEST EQUIPMENT

DEVELOPMENT CORP. OCEANSIDE, NEW YORK, U.S.A.



I. C. Lane, B.S., M.A., President, Radio-Television Training Association, Executive Director, Pierce School of Radio & Television.

VETERANS - - NON-VETERANS LET ME HELP YOU EARN TOP MONEY in TELEVISION — as I've helped these men —

LEARN TELEVISION AT HOME IN YOUR SPARE TIME

Now, while demand for trained men is rising, you can prepare for a top-pay, life-time career as an electronic technician, television repairman, or studio technician . . . or set up your own profitable business. You don't need any experience whatsoever to add your name to my list of hundreds of successful graduates.

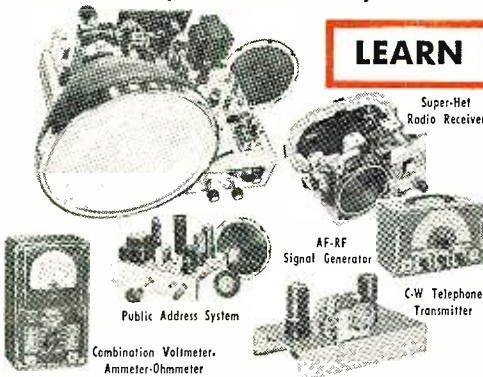

LEARN BY DOING

As part of your training I give you the equipment you need to set up your own home laboratory and prepare for a BETTER-PAY TV JOB. You build and keep an Electromagnetic TV RECEIVER designed and engineered to take any size picture tube up to 21-inch. (10-inch tube furnished. Slight extra cost for larger sizes.) . . . also a Super-Het Radio Receiver, AF-RF Signal Generator, Combination Voltmeter-Ammeter-Ohmmeter, C-W Telephone Transmitter, Public Address System, AC-DC Power Supply. Everything supplied, including all tubes.

STUDY NEWEST DEVELOPMENTS

My training covers all the latest developments in the fast-growing Television-Radio-Electronics industry. You learn about FM — RADAR — COLOR TV — TRANSISTORS — PRINTED CIRCUITS, etc.

CHOOSE FROM THREE COMPLETE COURSES

covering all phases of Radio, FM and TV

1. Radio, FM and Television Technician Course — no previous experience needed.
2. FM-TV Technician Course — previous training or experience in radio required.
3. TV Cameraman and Studio Technician Course — advanced training for men with Radio or TV training or experience.

EXTRA TRAINING IN NEW YORK CITY AT NO EXTRA COST!

After you finish your home study training in Course 1 or 2 you can have two weeks, 50 hours, of intensive Lab work on modern electronic equipment at our associate resident school, Pierce School of Radio and Television. THIS EXTRA TRAINING IS YOURS AT NO EXTRA COST WHATSOEVER!

FCC COACHING COURSE

Important for BETTER-PAY JOBS requiring FCC License! You get this training AT NO EXTRA COST! Top TV jobs go to FCC-licensed technicians.

EARN WHILE YOU LEARN

Almost from the very start of your course you can earn extra money by repairing sets for friends and neighbors. Many of my students earn up to \$25 a week . . . pay for their entire training with spare time earnings . . . start their own profitable service business.

FREE! I'll send you my new 40-page book, "How to Make Money in Television. - Radio - Electronics," a Free sample lesson, and other literature showing how and where you can get a top-pay job in Television.



Radio Television Training Association

52 EAST 19th STREET • NEW YORK 3, N. Y.

Licensed by the State of New York • Approved for Veteran Training

March, 1956

AIRCRAFT INSPECTOR

"With RTTA training and through repairing radios and televisions for the right people at the right price, I was able to make the right contacts. I am now an Inspector for Douglas Aircraft at about \$125 a week."



Hugh Maddox, Los Angeles, Calif. 6/30/54

\$60 A WEEK IN SPARE TIME

"I have the skill and know-how to do the work I love best and to enjoy better things in life, thanks to RTTA. I am now working at TV servicing and making \$60 a week spare time."

Harold Gimlen, Flint, Mich. 6/21/54

ASSISTANT MANAGER

"I am Assistant Manager of Day and Nite TV Service."

Ronald W. Curry, Tulsa, Okla. 1/3/55



EARN EXTRA MONEY

"RTTA training gave me a chance for my own business, extra money earned, and more things that the price of the course could never equal."

Bryce Ruffle, Peterborough, Ontario, Can. 4/2/55

FEELS FULLY QUALIFIED

"With your training I feel fully qualified to get out and compete with all radio mechanics in this area. I have over \$1,500 invested in test equipment, \$1,000 in tube stock and \$200 in miscellaneous equipment. Since I haven't had one complaint in 9 months I have been servicing sets, your school must have done a good job."



Jim Martin, Collinsville, Ill. 3/27/55

VETERANS

My School fully approved to train Veterans under new Korean G. I. Bill. Don't lose your school benefits by waiting too long. Write discharge date on coupon.

MAIL THIS COUPON TODAY!

Mr. Leonard C. Lane, President
RADIO-TELEVISION TRAINING ASSOCIATION
Dept. T-3C, 52 East 19th Street, New York 3, N. Y.

Dear Mr. Lane: Send me your NEW FREE BOOK, FREE SAMPLE LESSON, and FREE aids that will show me how I can make BIG MONEY IN TELEVISION. I understand I am under no obligation.

(PLEASE PRINT PLAINLY)

Name _____ Age _____

Address _____

City _____ Zone _____ State _____

I AM INTERESTED IN:

Radio-FM-TV Technician Course

FM-TV Technician Course

TV Cameraman & Studio Technician Course

VETERANS!
Write discharge date

NO OBLIGATION!

ONLY **RAYTHEON** PICTURE TUBES .

CORONA INHIBITOR

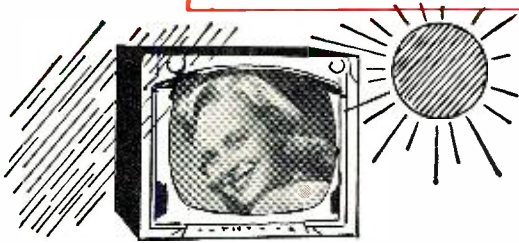

This Raytheon development insures brightness rain or shine. Ordinary tubes lose up to 10% of their brightness on humid, damp days. Not so, Raytheon Picture Tubes. Tests prove *no loss of brightness* even under a water spray on the high voltage contact — thanks to *Corona Inhibitor*.

CROSS-CHECK CONTROL

DAILY QUALITY CONTROL SUMMARY

Tube Type	OK	Def.	Comments
21A7PA	127	0	
17HPA	62	0	
21ALPLA	59	1	

Lot Dispositions: Passed

Tests	OK	Def.
Pressure	6	0
Torque	10	0
Brand & Etch	246	3
Tape	5	0

Date: 11/21/55

Tube Type	Serial #	Defect	Oper.	Pack Shift	Comments
21ALPLA	0895912	Loose Base	IS	1st	Major reject

% Defective Mon. ___ Tues. ___ Wed. ___ Thur. ___ Fri. ___ Sat. ___

Mount Line	Good	Defective	% Defective
Focus Assembly	-	-	-
Cathode Assembly	-	-	-
Planned Mount	50	0	0%

Disposition: Passed

Raytheon Picture Tubes are *right* when you get them, thanks to RAYTHEON'S CROSS-CHECK QUALITY CONTROL. This comprehensive Raytheon quality control method includes daily tests made on tubes for pressure, base torque and outside coating adhesion. Engineering controls check screen color and brightness and tube life under both ideal and extremely adverse conditions. And, most important of all, a substantial percentage of every day's production is actually *unpacked and retested for physical appearance and electrical characteristics* before quality control headquarters will permit release of a single tube for shipment.

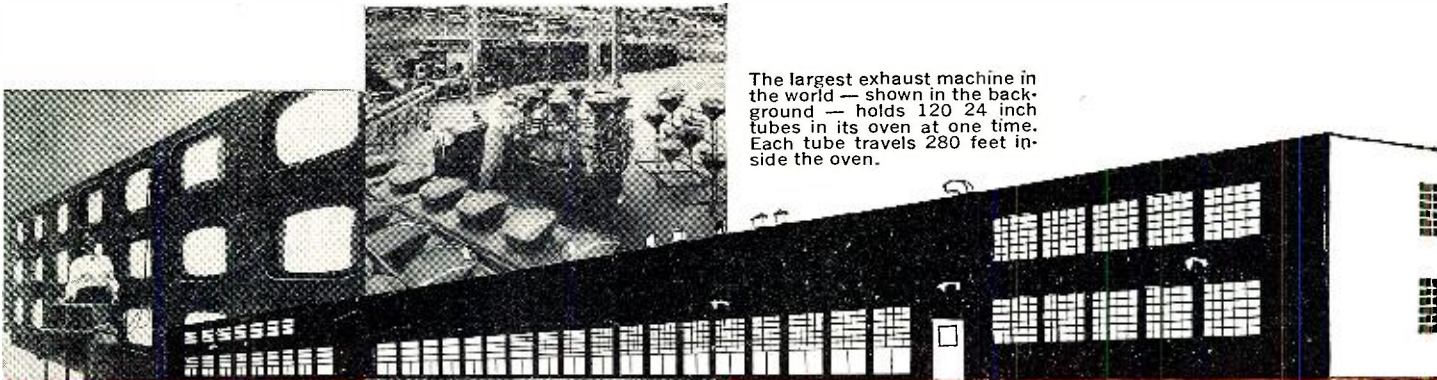

The largest exhaust machine in the world — shown in the background — holds 120 24 inch tubes in its oven at one time. Each tube travels 280 feet inside the oven.

Giant life test racks constantly check and guard the quality and life performance of Raytheon Picture Tubes.

Raytheon Picture Tubes are carefully baked out, here, in the largest oven of its kind ever made.

Raytheon Picture Tubes have the distinct advantage of precision production in one of the world's most modern plants. The Raytheon Cathode Ray Tube Plant in Quincy, Mass. houses some of the world's largest equipment and was designed and built solely for the manufacture of today's large screen Raytheon Picture Tubes.

give you these major advantages

ALUMINIZED
with

Lumilac

LUMILAC — a lacquer especially blended and used exclusively by Raytheon — is the secret of the superiority of Raytheon Aluminized Picture Tubes. This amazing lacquer produces an extra smooth, unbroken surface for the pure aluminum coating, yet leaves no gas-producing residues which could impair cathode emission and shorten tube life.

The result — all the benefits of aluminized tubes, sharper picture, superior contrast, high light output — *plus excellent tube life.*



RAYTHEON MANUFACTURING COMPANY

Receiving and Cathode Ray Tube Operations

Newton, Mass. • Chicago • Atlanta, Ga. • Los Angeles, Calif.

Raytheon makes all these } Receiving and Picture Tubes, Reliable Subminiature and Miniature Tubes, Semiconductor Diodes, Power Rectifiers and Transistors, Nucleonic Tubes, Microwave Tubes



Rauland

"GOLDEN SERIES"

HIGH FIDELITY

Custom
Quality
Hi-Fi
Components



Sensibly
Priced
for
Everyone

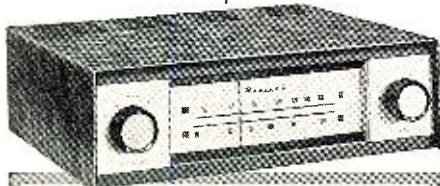

Golden Star MODEL HF255
AM-FM TUNER

Provides exceptional AM-FM reception, true high fidelity realism with "space-saver" convenience and beauty at remarkably low cost. FM response, ± 0.5 db, 20 to 20,000 cycles; AM, ± 4 db, 20 to 5,000 cycles. Sensitivity: FM—5 microvolts for 20 db of quieting; AM—20 microvolts for 1 volt output. Includes AFC, drift-compensated circuits, FM di-pole antenna, AM ferrite loop, etc. Only $3\frac{1}{2}$ " high. Ideal for use with amplifier below.

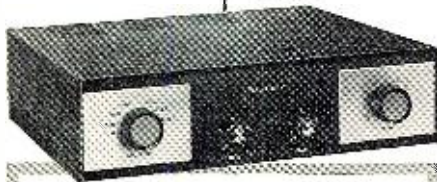

MODEL 1512
Golden Chief 12-WATT
HIGH FIDELITY AMPLIFIER

True hi-fi performance at moderate cost. Full 12 watts output; response, ± 0.5 db, 20 to 20,000 cps. Features 5 inputs; separate bass, treble controls; equalization for EUR, ffr, RIAA, Quiet; variable damping control, choice of volume control or loudness control. In compact cabinet, only $3\frac{1}{2}$ " high.

BEAUTIFUL "SPACE SAVER" DESIGN

RAULAND matching Hi-Fi units are decorator-styled in handsome charcoal black with marbled gold finish, control panels in soft brushed brass. Designed to fit anywhere—no cabinets required. (Extension shafts available for behind-panel mount.)



Hear these RAULAND units at your
Hi-Fi dealer, or write for details

RAULAND-BORG CORPORATION
3515 W. Addison St., Dept. B, Chicago 18, Ill.

Within the Industry

JOHN D. VAN DER VEER has been appointed general sales manager of *Tung-Sol Electric Inc.* of Newark, N. J.

He succeeds George W. Keown who was elected vice-president of the firm. Mr. Van der Veer joined the company in 1945 following service in the Signal Corps as a captain. He held the position of western equipment tube sales manager until 1950 when he assumed equipment tube sales responsibility for all territories. He was named assistant general sales manager in 1954.



CORNELL-DUBILIER ELECTRIC CORP. has moved its midwest sales office to 5247 W. Diversey Avenue, Chicago 39, Illinois. The new office is the focal point for both manufacturer and distributor sales and service of all *C-D* products in the midwestern states . . .

BOGUE ELECTRIC OF CANADA, LTD. has opened new production and administrative headquarters in a modern plant recently completed at Gloucester, near Ottawa, Ontario . . . The offices of **AERONAUTICAL RADIO, INC.** have been moved to 1700 K Street, N.W., in Washington, D.C. . . . A new multi-million dollar factory, research laboratory, and general office structure is being erected by **AUTOMATIC ELECTRIC COMPANY** on a 170 acre site on Wolf Road just north of North Avenue in Northlake, Illinois. The sixteen million dollar structure is expected to be in operation by late 1957. . . . The Microwave and Industrial Products Department at **MOTOROLA, INC.** has moved into its own one-story building at 1400 N. Cicero Avenue, Chicago 51, Illinois . . .

C. P. CLARE & CO. has opened a new production unit at Fairview, N. C. The company's line of custom-built relays and switches will be produced in the new factory as well as in the firm's Chicago plant . . . **ROBINS INDUSTRIES CORP.** has moved its factory and offices to larger quarters at 214-26 41st Ave., Bayside 61, New York . . . **WATERS MANUFACTURING, INC.** of Waltham has built a new 10,000 square foot building on Boston Post Road, Wayland, Massachusetts, to increase production facilities for its line of precision pots and electronic instruments . . . **NARDA CORPORATION** is now operating from a new factory at 160 Herricks Road, Mineola, Long Island, New York . . . **ELECTRO ENGINEERING WORKS** of Oakland, California, has broken ground for the construction of a modern, 15,000 square

foot manufacturing facility in San Leandro, California . . . **AMERICAN ELECTRONICS, INC.** has opened a marketing division at 655 W. Washington Boulevard in Los Angeles . . . **COOK ELECTRIC COMPANY** of Chicago has opened a new district office at 21015 Lorain Ave., Fairview Park, Cleveland 26, Ohio . . . **SNYDER MFG. CO.** has completed construction of an 80,000 square foot warehouse adjacent to its plant in Philadelphia . . . **BALDWIN-LIMA-HAMILTON CORPORATION** is building a new manufacturing plant at Waltham, Mass., to house its newly organized electronics and instruments division. Completion is scheduled for September 1 of this year . . . **PHILCO CORPORATION** has acquired a plant in Spring City, Pa., for the manufacture of transistors, diodes, and other semiconductor devices. The new facility provides nearly 100,000 square feet of manufacturing floor space.







DAVID T. SCHULTZ has been elected president and director of *Allen B. Du Mont Laboratories, Inc.* He succeeds Dr. Allen B. Du Mont, retiring president, who has been elevated to the post of chairman of the board.

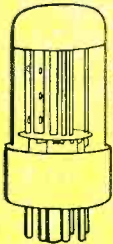

Mr. Schultz was vice-president, treasurer, and director of *Raytheon Manufacturing Company* for more than twenty-five years before assuming his new post. The firm he now heads operates four major plants in northern New Jersey and one in Los Angeles and employs more than 4000 persons.

COLLINS RADIO COMPANY of Cedar Rapids, Iowa, has acquired all of the assets of **COMMUNICATION ACCESSORIES COMPANY** of Hickman Mills, Missouri, through an exchange of stock. The new subsidiary will be operated as an independent unit in the component field . . . **MAG-ELECTRIC PRODUCTS INC.** of Hawthorne, California, has been acquired by **NATIONAL AIRCRAFT CORPORATION** of Burbank and will be operated at its present location as a wholly-owned subsidiary. The new acquisition will allow the parent firm to expand its activity in the electronic component field and supplement its transistor activities . . . **PENN-TEXAS CORPORATION** has completed negotiations for the purchase of the business and all the assets of the **HALLICRAFTERS COMPANY**, Chicago manufacturer of military, communications, and home equipment . . . **CANNON ELECTRIC COMPANY** has purchased the facilities,

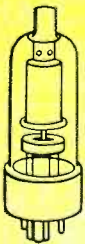
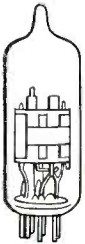
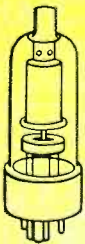
RADIO & TELEVISION NEWS

<p>SYLVANIA</p> <p>6SN7GTB</p> <p>ELECTRONIC TUBE</p>		<p>SYLVANIA</p> <p>6AU6</p> <p>ELECTRONIC TUBE</p>	
	<p>SYLVANIA</p> <p>6BQ6GTA</p> <p>ELECTRONIC TUBE</p>		<p>SYLVANIA</p> <p>5U4GB</p> <p>ELECTRONIC TUBE</p>
<p>SYLVANIA</p> <p>6CB6</p> <p>ELECTRONIC TUBE</p>		<p>SYLVANIA</p> <p>6CB6</p> <p>ELECTRONIC TUBE</p>	
<p>SYLVANIA</p> <p>1B3GT</p> <p>ELECTRONIC TUBE</p>		<p>SYLVANIA</p> <p>1B3GT</p> <p>ELECTRONIC TUBE</p>	

How to get the jump on call-backs in 6 easy moves

Here are six tube types called for most in your daily service work. Eliminate the call-backs from these types and your biggest share of headaches is over. It's easy to do just that, too, simply by getting into the habit of using only Sylvania tubes ... in the familiar yellow and black carton.

These 6 types alone incorporate over 14 design and production improvements to eliminate the most common causes for "quick failures" and costly call-backs. It's no wonder more and more servicemen consider the yellow and black carton their "calling card of top quality service."

 **SYLVANIA**[®]

SYLVANIA ELECTRIC PRODUCTS INC.
1740 Broadway, New York 19, N. Y.
In Canada: Sylvania Electric (Canada) Ltd.
University Tower Building, Montreal

LIGHTING • RADIO • ELECTRONICS • TELEVISION • ATOMIC ENERGY

March, 1956

27

TECHNICAL BRILLIANCE PLUS

with ALTEC LANSING

Every product of Altec Lansing conforms to the high standards of technical excellence which have made Altec the unchallenged leader in the field of professional sound. Every Altec product carries the unique *Performance Guarantee* that the unit meets or exceeds its published specifications.

Altec... and only Altec... gives you the plus of superb design and beautiful cabinetry that carries the Hardwood Association Seal. Outstanding examples of this perfect combination of flawless performance and functional beauty are shown below.

See your Altec dealer soon for a demonstration of this or other Altec Lansing high fidelity systems, priced from \$324. to \$1180.

Write Dept. 3-TM for complete Altec Home Music Catalog.

physical assets, inventory in progress, and orders on hand of the **DIAMOND MANUFACTURING COMPANY** of Wakefield, Mass. The parent company will take over the line of coaxial connectors which has been manufactured for many years under the "Dico" trade-name.

* * *

MARK SHEPHERD, JR. has been promoted to the post of vice-president in charge of the semiconductor products division of *Texas Instruments Incorporated* of Dallas, Texas.



He has been in charge of semiconductor products manufacture at the company for three years. As vice-president of the division he will continue to be responsible for product development, manufacture, sales, and administration. He will make his headquarters at the firm's main plant at 6000 Lemmon Avenue in Dallas.

* * *

SARKES TARZIAN, INC. has acquired all of the facilities of *Silicon Corporation of America* and will operate the firm as part of its Rectifier Division.

All orders placed with either company are being filled from Bloomington, Indiana. Complete production facilities have been transferred to Bloomington and expanded to meet the demand for silicon rectifiers.

Key personnel of the subsidiary have joined the parent firm at Bloomington.

* * *

RETMA has scheduled a symposium on reliable applications of electronic tubes at the Irvine Auditorium of the University of Pennsylvania, Philadelphia on May 22nd and 23rd.

Complete information on the program and details regarding registration are available from J. A. Caffiaux, staff engineer, RETMA, Engineering Department, 650 Salmon Tower, 11 W. 42nd Street, New York 36, N. Y.

* * *

WILLIAM McAULAY has been named manager of application engineering at *Eitel - McCullough, Inc.*, San Bruno, California manufacturer of *Eimac* electron-power tubes.

He joined the company's field engineering department in 1954 as an assistant in the division he will now head. He has been active in the broadcasting and electronics fields for many years. He has been a member of the IRE since 1930 and an amateur radio operator for 32 years.



* * *

REAR ADMIRAL STANLEY F. PATTEN (RET.), vice-president of *Allen B. Du Mont Laboratories, Inc.*, has been elected president of the New York Chapter of the Armed Forces Communications and Electronics Association.

(Continued on page 135)

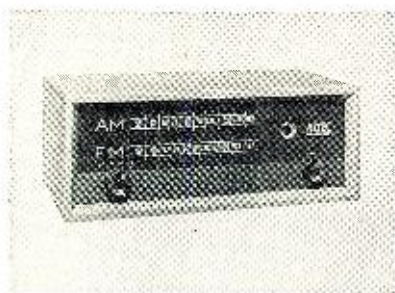

304A TUNER

THE FINEST AM-FM RECEIVER AVAILABLE

—540 — 1720 kilocycles AM range • 88-108 megacycle FM range • exceptional stability • outstanding sensitivity • output matched to 440B • mahogany or blond... \$186.00

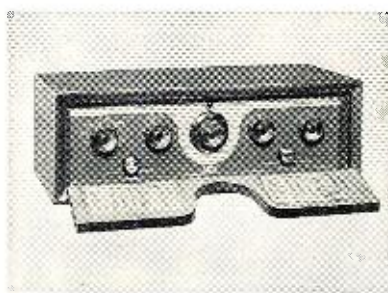

440B PREAMPLIFIER

OUTSTANDING CONTROL, FLEXIBILITY AND QUALITY

five inputs for phono, mic., tape, and tuner • two outputs; main amplifier, recorder • 25 crossover selections for maximum record quality • tape playback monitoring circuit • quality engineered circuitry • mahogany or blond... \$149.00

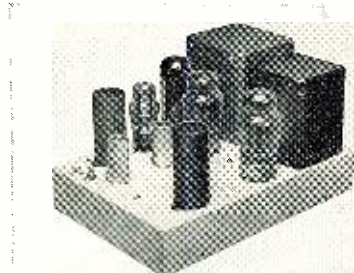

340A AMPLIFIER

ENGINEER'S CHOICE AMONG PREMIUM AMPLIFIERS

A₁ professional circuit for long lived stability • no circuit balancing required • 35 watts, less than 0.5% harmonic distortion • $\pm 1/2$ db 5 to 100,000 cycles • 66.5 db gain • variable output impedance... \$159.00

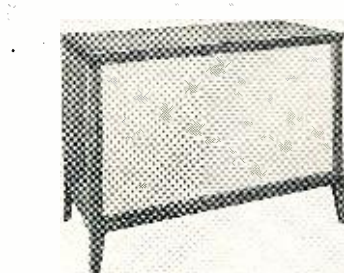

826A SPEAKER SYSTEM

PROFESSIONAL COMPONENTS CABINETED FOR THE HOME

35 to 22,000 cycle range • 15" woofer • high frequency driver and sectoral horn • 800 cycle dividing network with balancing facilities • proved components used in thousands of motion picture theatres • mahogany or blond... \$324.00

ALTEC FIDELITY IS HIGHEST FIDELITY

Dept. 3-TM
9356 Santa Monica Blvd., Beverly Hills, Calif.
161 Sixth Avenue, New York 13, N. Y.





National Schools Graduates Prove
**AGE & PREVIOUS EDUCATION
NO BARRIERS TO SUCCESS!**

Get into **HIGH-PAYING
TELEVISION
ELECTRONICS-RADIO!**

Are you
between
17-55?

LEARN AT HOME
IN SPARE TIME!

Are you
alert, sincere,
ambitious?

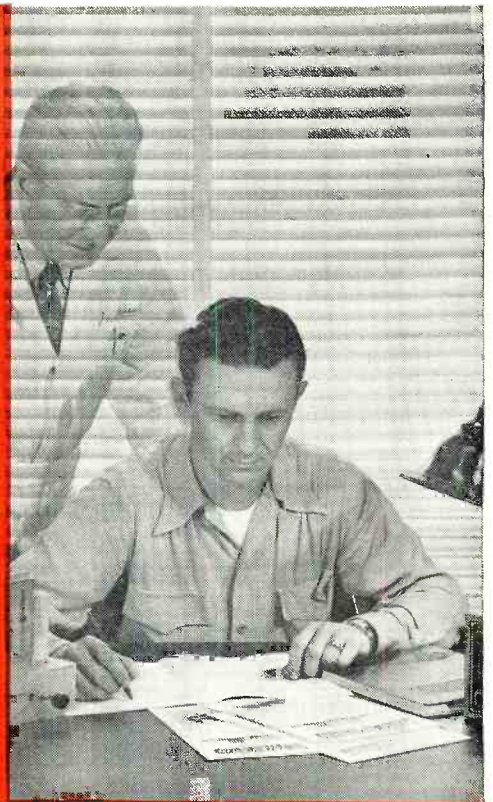

Master all Phases with our amazing
**Shop-Method Home Training & Practical
Equipment! We have trained Thousands
for Big-Pay Jobs! WE WILL TRAIN YOU!**



SET REPAIR IS PROFITABLE!

Our easy Shop-Method Lessons & Manuals cover this Profitable Field! **LOW TUITION.** Opportunity to **EARN AS YOU LEARN!** Free Placement Assistance. Help with technical and personal problems. Send coupon for free **ILLUSTRATED BOOK**, "Your Future in TV-Radio-Electronics."

**OPPORTUNITIES WIDE OPEN IN THESE
AND OTHER SPECIALIZED FIELDS!**

Loudspeaker Systems TV-Radio Service,
Hi-Fi, F.M., Tape Recording Installation-Repair
Your own business Sales and Distribution

COLOR TV & ELECTRONICS

— America's Fields of the Future!
Thousands of **TRAINED TECHNICIANS** will make "small fortunes" in the next few years.



**ATTENTION DRAFT-AGE
MEN!** National Schools
training prepares you for **HIGHER
RATINGS & PAY GRADES!**

NATIONAL SCHOOLS

TECHNICAL TRADE TRAINING SINCE 1905
Los Angeles 37, Calif. Chicago: 187 N. La Salle St.
In Canada: 811 W. Hastings St., Vancouver, B. C.

50 YEARS' EXPERIENCE

training Men Like Yourself for Success!

KNOW YOUR SCHOOL! These are the national headquarters of National Schools' famous Shops, Labs & Studios. Get your Home Training and "sheepskin" direct from Los Angeles, recognized as a major "World Center of Electronics"!



**APPROVED FOR G. I. TRAINING
BOTH HOME STUDY AND RESIDENT COURSES OFFERED**

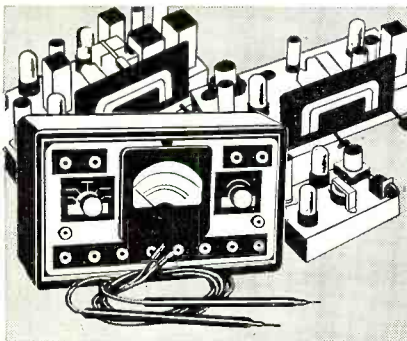

YOU RECEIVE THIS PROFESSIONAL MULTITESTER—a must for every Technician! Also standard parts to build Receivers, Oscillators, Signal Generator, Continuity Checker, Short Wave & Standard Broadcast Superhet Receiver, many other units. All part of your course, all yours to keep. Mail coupon today!

You can't buy
these Valuable
Books, but we
send them **FREE!**
MAIL COUPON!

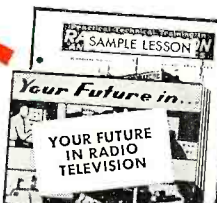

ACT NOW! MAIL NOW TO NEAREST OFFICE!

(mail in envelope or paste on postal card)

NATIONAL SCHOOLS,

4000 S. FIGUEROA ST., LOS ANGELES 37, CALIF. or 187 N. LA SALLE ST., CHICAGO, ILL.
Please rush **FREE** TV-Radio Book & Sample Lesson. I understand there is no obligation, no salesman will call.

NAME _____ BIRTHDAY _____ 19 ____

ADDRESS _____

CITY _____ ZONE _____ STATE _____

Check if interested **ONLY** in Resident Training at Los Angeles. **VETERANS:** Give date of Discharge _____

it's the 'guts' in the **Pilot** chassis
that make the critical difference

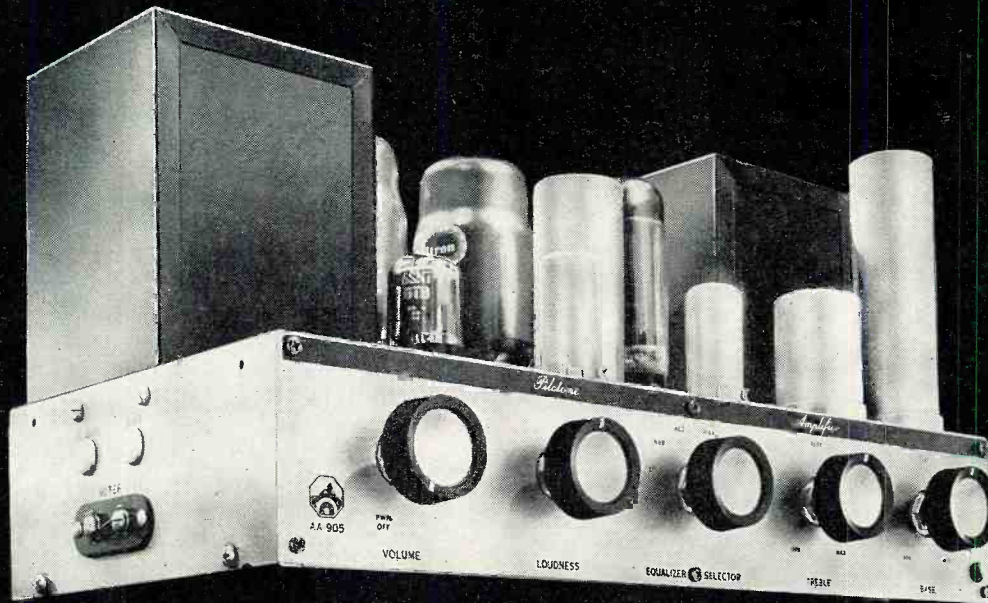

Over 35 years



Leadership in Electronics

PILOTONE AMPLIFIERS

Of major importance in the performance of a high fidelity amplifier are its component parts: the condensers, resistors, transformers—especially the transformers—and above all, the output transformer.

All transformers look alike in the schematic but that's where the similarity ends. This is one case where 'a boy can't be expected to do a man's job'. No puny output transformer—however imposing the outer shell—can serve a good high fidelity amplifier without introducing distortion. It takes plenty of 'iron'—not to mention special winding methods—for an output transformer to handle the power output cleanly.

Inspect the Pilotone amplifiers—all 5 of them—and compare them critically with the others in the field—regardless of make, power rating or price. Notice how much heavier the output transformers in the Pilotone amplifiers actually

are. Even the power transformers—how much cooler they 'run' in operation. Observe also that the Pilotone amplifiers employ known brand-name condensers and resistors generously rated to provide wide margins of safety against failure and breakdown.

After all, tubes are tubes and sockets are sockets, but it's the 'guts' in and on the chassis that make the critical difference in performance. If you look for these things when you choose *your* amplifier, we know that—like many others—you too will select one of these Pilotone amplifiers for your own home music system.

PILOTONE AMPLIFIERS

AA-410 .. \$54.50 AA-420 .. \$99.50*
AA-903 .. 69.50* AA-904 .. 99.50
AA-905 (illustrated) .. \$129.50*

Metal amplifier covers.....each 4.95

*with built-in Preamp

NOTE: Prices slightly higher West of Rockies

See your dealer for a Pilot Hi-Fi Demonstration — For complete literature on Pilotone Amplifiers, Pilotuners and other high fidelity units, write to: Dept. GC-4

the

Pilot

RADIO CORPORATION

37-06 36th STREET, LONG ISLAND CITY 1, N. Y.

The Future of Servicing

By **DR. W. R. G. BAKER**
Vice-Pres., General Electric Co.
General Manager, G-E Electronics Div.

Will the use of modules, printed wiring and circuits, and transistors eliminate the need for servicing? How can the service technician prepare for the future?

THE continued development of new materials and new techniques is a prerequisite of electronic progress. For that reason, we may expect to see many new applications in the next few years of some of our newer electronic components such as transistors, miniaturized parts, and printed circuits, as well as other products engineered to give electronic equipment longer life, more ruggedness, and greater stability.

The benefits of these characteristics to the purchaser are obvious. If new components do bring the longer life we believe they will, then it is to be assumed that the end product will be more attractive to the consumer because the number of service calls per individual unit will be reduced. This does not mean, however, that the number of service calls per service technician will show a corresponding reduction. With the continuing increase in home television and radio receivers in use we may anticipate that this greater volume may be reflected in similar health for the entire service industry.

It should be recognized, when we consider servicing of electronic equipment for the years ahead, that design emphasis necessarily is on products that will work well, rather than on that small portion of total production which, for various reasons, may eventually suffer equipment failure. Because we build with this goal in mind—that of continually making our goods more efficient—servicing considerations sometimes become secondary to the primary objective of product improvement.

Therefore, while we are striving to make the end product better, we may well be creating new problems for the electronic service technician. What is simplification at the factory level, in regard to basic set construction and new assembly techniques, will undoubtedly mean complication for the service technician in some instances. An illustration of this point may be found in the work now being done in miniaturization. Whenever service is required on any product dealing with a miniature component, it is going to be more difficult for the technician to isolate the trouble. Clearances are small. In some instances, they are as little as a cubic eighth of an inch. While seeking the cause of one defect, the service specialist will have to be more proficient in his work than he is today, to avoid causing new sources of trouble.

Generally, service people will have to be more adept in the future in reading schematics. While there probably will be no basic change in the schematic itself, it will take practice for the technician to translate the schematic into the actual layout of printed circuitry. In this regard, part of the burden falls upon the manufacturer. Technical publications will have to be developed which will serve as a better guide to the radio, television, and electronics service specialist.

Complexity will make itself felt in many ways as new circuits are designed. The advent of color television is a typical example. While better equipment will eliminate certain classes of problems, more complex circuitry will provide new ones to tax the service technician's capabilities.

A good analogy here, we think, is the revolution which

Dr. W. R. G. Baker, vice-president of the General Electric Company and general manager of its Electronics Division, has had nearly four decades of experience in telecommunications and is one of the world's pioneers in the field of electronics. He has won national acclaim for his work as chairman of two National Television System Committees, which developed standards for monochrome television in 1941 and color television in 1953. Today, his name appears in a place of leadership on virtually every committee appointed to study electronics problems, both civilian and military. He has been awarded the Medals of Honor of both the I. R. E. and the RETMA. He helped develop radio devices for aircraft and ships in World War I and during World War II, he was cited for contributions to the development, design,

and production of complex radar and radio equipment for the military. Dr. Baker was born in Lockport, N. Y., November 30, 1892. He attended high school at Lockport and received his Bachelor of Science Degree in Engineering from Union College in 1916. He won his Master's Degree in Electrical Engineering in 1918 and holds three honorary degrees: Doctor of Science, Union College, 1935; Doctor of Engineering, Syracuse University, 1951; and Doctor of Engineering, Brooklyn Polytechnical Institute, 1955. Dr. Baker joined General Electric Company at Schenectady in 1917 and was named design engineer in charge of transmitters four years later. In 1924, he was appointed design engineer for all radio products. In 1926, he was placed in charge of radio development, design, and production. He was designated as managing engineer for radio receivers at Bridgeport, Conn., in 1935, and manager of radio and television at Schenectady and Bridgeport in 1939. Dr. Baker has been a vice-president of General Electric Company since 1941. His headquarters, at Syracuse, N. Y., supervises the activities of G-E electronic plants and laboratories from coast to coast. Products of his division range from tiny transistors to military radar systems.



has taken place over the years in the common household toaster. In the old days, all that a toaster required was a good plug and a good heating element. When those requirements were met, the need for servicing diminished. Then came the highly desirable features of pop-up, time controls, and other new equipment. The toaster became more complex and the repair task became more difficult. We may expect the same thing to happen with electronic circuitry and electronic equipment whenever new features are added.

It will be to the advantage of service specialists, then, to start preparing now for the complexity we know will come in the future. Technicians should get acquainted now with the fundamentals used in transistor systems, for example, as a bulwark against the day when many new circuit applications will make available many new commercial products.

We are coming into a period when there will be more public reliance on the service specialist who lives up to a high standard of qualification. In the years ahead, it will be the qualified technician who will get the lion's share of the available service business.

If there is one point we would emphasize it is this, all parts of the electronics business necessarily are interdependent. Progress cannot be made in one area alone while the others lag behind. The future of servicing will depend on the ability of the service end of the electronics business to keep pace with technological know-how being acquired elsewhere in the industry, and the future of the individual service technician will depend on whether he is able to grow personally with the tasks before him.

-30-

WHICH OF THESE

WELL-PAID JOBS* DO YOU WANT



RADIO and VHF TECHNICIANS

(Job #1160)

1

An oil development company has opening for Radio and VHF Technicians. Minimum of five years experience maintaining and installing standard commercial radio and VHF equipment. Salary is \$570.00 per month plus a service allowance amounting to \$224 per month.

AIRLINE RADIO

(Job #1128)

2

Nationally known airlines, New York, Chicago and Cleveland and other cities, has openings for Radio Operators and Radio Mechanics. Second class license or better. Periodic increases with opportunity for advancement. Many company benefits—paid vacations, free flight mileage allowance, group insurance, etc.

ELECTRONIC TECHNICIANS

(Job #1192)

3

Leading manufacturer of electronic equipment has many ground floor opportunities for technicians. Work involves design, construction and maintenance of the world's largest electronic digital computer.

GUIDED MISSILE TECHNICIANS

(Job #1183)

4

Large West Coast manufacturer has openings for Electronic Technicians for work in research and development, maintenance and calibration for electronic instrumentation. A wide variety of interesting design and development positions for technically trained men in assignments which range from initial design studies through development.

HERE'S PROOF CIRE TRAINEES GET WELL-PAID JOBS LIKE THESE . .

AIRLINES

"I replied to the Job Opportunities you sent me and I am now a radio operator with American Airlines. You have my hearty recommendation for your training and your Job-Finding Service."

James A. Wright, Beltsville, Md.

INDUSTRIAL ELECTRONICS

"Upon my discharge from the Navy I used your Job-Finding Service and as a result I was employed by North American Aviation in electronic assembly (final checkout)."

Glen A. Furlong, Fresno, Calif.

*WE CERTIFY THAT THESE JOBS ARE CURRENTLY AVAILABLE. FULL DETAILS ON THESE AND HUNDREDS MORE WILL BE SENT ON REQUEST.

YOUR FCC LICENSE AND CIRE DIPLOMA QUALIFY YOU FOR THE GOOD JOBS IN ELECTRONICS AND RADIO

Write Now For Complete Information

FIND OUT How to get your FCC commercial License. Fill Out The Coupon Below and Mail It . . Today!



An Approved Member

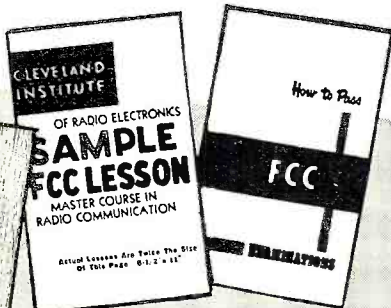

GET ALL 3 FREE

CLEVELAND INSTITUTE OF RADIO ELECTRONICS

Desk RN-88, 4900 Euclid Bldg., Cleveland 3, Ohio

(Address to Desk No. to avoid delay)

I want to know how I can get my FCC license in a minimum of time. Send me your FREE booklet, "How To Pass FCC License Examinations" (does not cover exams for Amateur License), as well as a Sample FCC-type lesson and the amazing new booklet "Money-Making FCC License Information." Be sure to tell me about your Television Engineering Course. PLEASE PRINT CAREFULLY.

NAME AGE

ADDRESS

CITY ZONE..... STATE.....

FOR PROMPT RESULTS, SEND AIR MAIL

Special tuition rates to members of the U. S. Armed Forces
Electronic Training Available To Canadian Residents.

CLEVELAND INSTITUTE OF RADIO ELECTRONICS

Carl E. Smith, E. E., President

4900 Euclid Bldg.

Desk RN-88

Cleveland 3, Ohio

RADIO & TELEVISION NEWS

**NEW! COLOR and Black-&White
LAB & TV 5" OSCILLOSCOPE #460
KIT \$79.95. Wired \$129.50**

The **FINEST** professional 5 mc wide-band scope value. Ideal for research, h-f & complex waves, plus Color & Monochrome TV servicing. Flat from DC to 3.58 mc ± 1 db (color burst freq.), flat DC to 4.5 mc $+1, -3$ db. Vert. sens. 25 rms mv/in. Vert. Z 3 megs. Has the following outstanding features not found in scopes up to several times its price, kit or wired:

VERTICAL AMPLIFIER: direct-coupled (DC) thruout to eliminate l-f phase shift; push-pull thruout for negligible distortion; K-follower coupling between push-pull pentode stages for extended h-f resp. (minimizes h-f phase shift, extends useful resp. to 10 mc); full-screen undistorted vert. defl.; 4-step freq.-compensated decade step attenuator up to 1000:1. **SWEEP CIRCUIT:** perfectly linear sweeps, 10 cps - 100 kc (ext. cap. for down to 1 cps); **pre-set TV vert. & hor. positions** (30 & 7875 cps); automatic sync. ampl. & limiter eliminates sync amplitude adj. **PLUS:** direct or cap. coupling; bal. or unbal. inputs; edge-lit engraved lucite graph screen; dimmer; anti-glare filter; bezel fits std photo equipmt. **OTHER IMPORTANT FEATURES:** High intensity trace CRT. Finest sq. wave resp. (.06 usec rise time). Push-pull hor. ampl., flat to 400 kc, sens. 0.6 rms mv/in. Built-in voltage calibration. Intensity mod. Sawtooth & 60 cps outputs. Astigmatism control. Retrace blanking.

Instant, drift-free full-screen vert. positioning & 2X full-screen hor. positioning. Bal., cal., astig. adj. externally accessible. 5U1P CRT, 2-6AU8, 2-6CB6, 1-12AU7A, 2-6J6, 1-6AX5, 1-1V2. Deep-etched satin aluminum panel, rugged grey wrinkle steel cabinet. Designed for easy building at home with no special equipment. 13" x 8 1/2" x 16", 30 lbs.

SCOPE DIRECT PROBE* =PD: KIT \$2.75. Wired \$3.95. Eliminates stray-pick-up & signal re-radiation.

SCOPE DEMODULATOR PROBE* =PSD: KIT \$3.75. Wired \$5.75. Demodulates AM carriers between 150 kc and 250 mc.

SCOPE LOW CAPACITY PROBE* =PLC: KIT \$3.75. Wired \$5.75. For signal tracing in high frequency, high impedance & wide-band circuits (as in TV) without distortion from overloading or frequency discrimination.

for **COLOR** and Monochrome TV servicing

**New! PEAK-to-PEAK VTVM #232
& UNI-PROBE (pat. pend.)
KIT \$29.95. Wired \$49.95**

UNI-PROBE: exclusive with EICO! Terrific time-saver! Only 1 probe performs all functions—a half-turn of probe-tip selects DC or AC-Ohms.

The new leader in professional peak-to-peak VTVMs. Latest circuitry, high sensitivity & precision, wide ranges & versatility. Calibration without removing from cabinet. New balanced bridge circuit. High Z input for negligible loading. 4 1/2" meter, can't-burn-out circuit. 7 non-skip ranges on every function. 4 functions: +DC Volts, -DC Volts, AC Volts, Ohms.

Uniform 3 to 1 scale ratio for extreme wide-range accuracy. Zero center. One zero-adj. for all functions & ranges. 1% precision ceramic multiplier resistors. Measure directly peak-to-peak voltage of complex & sine waves: 0-4, 14, 42, 140, 420, 1400, 4200. DC/RMS sine volts: 0-1.5, 5, 15, 50, 150, 500, 1500 (up to 30,000 v. with HVP probe, & 250 mc with PRF probe). Ohms: 0.2 ohms to 1000 megs. 12AU7, 6AL5, selenium rectifier; xfmr-operated. 8 1/2" x 5" x 5". Deep-etched satin aluminum panel, rugged grey wrinkle steel cabinet. 7 lbs.

**New! DELUXE PEAK-to-PEAK VTVM #249
with 7 1/2" METER & UNI-PROBE (pat. pend.)
KIT \$39.95. Wired \$59.95**

All the advanced & exclusive features of #232—PLUS the extra convenience and readability of its big 7 1/2" meter. Your ideal bench instrument.

VTVM RF PROBES* #PRF-11 or PRF-25: KIT \$3.75. Wired \$4.95. Accuracy $\pm 10\%$. Use with any 11 or 25 megohm VTVM.

VTVM HV PROBE #HVP-2: Wired \$4.95. Complete with multiplier resistor. Measures up to 30 kv with any VTVM or 20,000 ohms/volt VOM.



Calibration without removing from cabinet.

Visit our
BOOTH 209-211,
IRE SHOW

*Only EICO Probes have all these features: fully shielded; rugged terminal board parts mounting; shock-mounted floating construction; swivel-action; color-coding; easy parts accessibility.



© 56

March, 1956

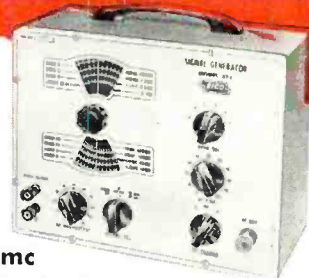

150 kc to 435 mc
with ONE generator!

**New! RF SIGNAL GENERATOR #324
KIT \$26.95. Wired \$39.95**

for **COLOR** and Monochrome TV servicing

New wide-range, stable generator — better value than generators selling at 2 or 3 times its cost! Ideal for: IF-RF alignment, signal tracing & trouble-shooting of TV, FM & AM sets; marker gen.; 400 cps audio testing; lab. work. **6 fund. ranges:** 150-400 kc, 400-1200 kc, 1.2-3.5 mc, 3.5-11 mc, 11-37 mc, 37-145 mc; 1 harmonic band 111-435 mc. Freq. accurate to $\pm 1.5\%$; 6:1 vernier tuning & excellent spread at most important alignment freqs. Etched tuning dial, plexiglass windows, edge-lit hairlines. Colpitts RF osc., directly plate-modulated by K-follower for improved mod. Variable depth of int. mod. 0-50% by 400 cps Colpitts osc. Variable gain ext. mod. amplifier: only 3.0 volts needed for 30% mod. Turret-mounted coils slug-tuned for max. accuracy. Fine & Coarse (3-step) RF attenuators. RF output 100,000 uv; AF sine wave output to 10 volts. 50-ohm output Z. 5-way jack-top binding posts for AF in/out; coaxial connector & shielded cable for RF out. Tubes: 12AU7, 12AV7, selenium rectifier; xfmr-operated. Deep-etched satin aluminum panel, rugged grey wrinkle steel cabinet. 8" x 10" x 4 3/4". 10 lbs.

The specs are the proof...

**4 NEW BEST BUYS
by EICO**

**COMPLETE
with Preamplifier, Equalizer and Control Section
New! 20-WATT Ultra-Linear Williamson-
type HIGH FIDELITY AMPLIFIER #HF20
KIT \$49.95. Wired \$79.95**

A low-cost, complete-facility amplifier of the highest quality that sets a new standard of performance at the price, kit or wired. Every detail, down to the etched, brushed solid brass control plate, is of the fine quality EICO is famous for.

Rated power output: 20 watts (34 w peak). IM distortion (60 cps: 6 kc/4:1) at rated power: 1.3%. Mid-band harmonic distortion at rated power: 0.3%. Maximum harmonic distortion between 20 and 20,000 cps at 1 db under rated power: approx. 1%. Power response (20w): ± 0.5 db 20-20,000 cps; ± 1.5 db 10-40,000 cps. Frequency response (1/4w): ± 0.5 db ± 13 -35,000 cps; ± 1.5 db 7-50,000 cps.

5 feedback equalizations for LP's & 78's including RIAA. Variable turnover feedback tone controls do not affect volume & permit large boosts or cuts at either end of audio spectrum with mid-freqs. unaffected. Loudness control & separate level set control on front panel. Low Z output to tape recorder. 4 hi-level switched inputs: tuner, tv, tape, auxiliary (xtal/ceramic phono or 2nd tuner); 2 low-level inputs for proper loading with all leading magnetic, FM & quality xtal cartridges. Hum bal. control. Extremely fine output transformer has interleaved windings, tight coupling, careful balancing & grain-oriented steel. 8 1/2" x 15" x 10". 24 lbs.

These amazing EICO values are NOW IN STOCK at your nearest distributor. Examine them side-by-side with ANY competitor. You'll see for yourself why indeed EICO is your BEST BUY. Fill out coupon on reverse page.



TURN PAGE FOR MORE EICO VALUES...

84 Withers Street, Brooklyn 11, New York

Prices 5% higher on West Coast.

Do you OVERPAY for QUALITY instruments?

EICO's mass purchasing and world-wide distribution, together with advanced electronic design, produce values never before possible . . . to give you Laboratory Precision at Lowest Cost!

GET THE MOST for YOUR MONEY! Don't buy ANY test instrument till you put the EICO INSTRUMENT (kit or wired) equivalent before you—and . . .

Compare advanced electronic design: see the latest in circuitry and features.

Compare finest components: see the famous brands you know and trust, such as GE, Centralab, Mallory, etc.

Notice ease of construction and operation: Exclusive "Beginner-Tested" Manuals make assembly and operation step-by-step, quick, crystal-clear. "You build them in one evening—they last a lifetime!"

Check 5-Way Guarantee: Only EICO gives you this exclusive complete protection! EICO guarantees components, instructions and satisfactory operation — AND guarantees service and calibration for the LIFETIME of the instrument, at less than cost of handling.

Compare feature for feature, dollar for dollar.

There's an EICO distributor right nearby in your own neighborhood — over 1200 coast-to-coast. EICO planned it that way so that you can easily examine EICO BEFORE YOU PUT DOWN ONE CENT OF YOUR MONEY!

COMPARE any of EICO's 46 models SIDE BY SIDE with ANY competitor. Then YOU judge who's giving you the MOST for your money.

Over 500,000 EICO instruments in use . . . You'll agree EICO gives you LABORATORY PRECISION AT LOWEST COST.



FREE 1956 EICO CATALOG!

Tells you how to SAVE 50% on
your test equipment costs!

 <p>TUBE TESTER #625 KIT \$34.95 Wired \$49.95</p> <ul style="list-style-type: none"> tests 600 mil series string type tubes illuminated roll-chart <p>Pix Tube Test Adapter \$4.50</p>	<p>New! GEIGER COUNTER #803 KIT \$19.95 Wired \$29.95</p>  <p>(less batteries) Professional, all-electronic, sensitive, rugged—at lowest cost! Indicates by neon lamp & headphone clicks.</p>	<p>5" PUSH-PULL OSCILLOSCOPE #425 KIT \$44.95 Wired \$79.95</p>  <p>7" PUSH-PULL OSCILLOSCOPE #470 KIT \$79.95 Wired \$129.50</p>																											
 <p>VACUUM TUBE VOLTMETER #221 KIT \$25.95 Wired \$39.95</p> <p>DELUXE VTVM #214 (7 1/2" METER) KIT \$34.95 Wired \$54.95</p>	<p>RF SIGNAL GENERATOR #320 KIT \$19.95 Wired \$29.95</p>  <p>150 kc-34 mc calibrated harmonics to 102 mc. Pure or mod. RF, & Colpitts osc. 400 cps sine outputs.</p>	<p>CATHODE RAY TUBE CHECKER #630 KIT \$17.95 Wired \$24.95</p>  <p>Easy, fast test of all types & sizes TV pix & scope CR tubes, in set or carton.</p>																											
 <p>#944 FLYBACK TRANSFORMER & YOKE TESTER KIT \$23.95 Wired \$34.95</p> <ul style="list-style-type: none"> fast check all flybacks & yokes in or out of set. spots even 1 shorted turn! 	<p>Range 500 kc-228 mc on fund. Cont. sweep width control, 0-30 mc.</p>  <p>TV/FM SWEEP GENERATOR #360 5MC-4.5MC CRYSTAL \$3.95 ea.</p> <p>KIT \$34.95 Wired \$49.95</p>	<p>1% accuracy on all 7 ranges. Range 75 kc-150 mc. Volt reg.</p>  <p>DELUXE RF SIGNAL GENERATOR #315 KIT \$39.95 Wired \$59.95</p>																											
 <p>Sep. voltmeter & ammeter</p> <p>6V & 12V BATTERY ELIMINATOR & CHARGER #1050 KIT \$29.95 Wired \$38.95</p>	 <p>Sep. hi-gain RF & lo-gain audio inputs. Special noise locator. Calibrated wattmeter.</p> <p>DELUXE MULTI-SIGNAL TRACER #147 KIT \$24.95 Wired \$39.95</p>	 <p>Reads 0.5 ohms -500 megs, 10 mmfd-5000 mfd power factor.</p> <p>R-C BRIDGE & R-C-L COMPARATOR #950B KIT \$19.95 Wired \$29.95</p>																											
 <p>New! BATTERY TESTER #584 KIT \$9.95 Wired \$12.95</p> <p>Tests A & B portable radio, hearing aid, lantern, other batteries—in or out of equipment.</p>	 <p>20,000 Ohms/Volt MULTIMETER #565 KIT \$24.95 Wired \$29.95</p>  <p>1000 Ohms/Volt MULTIMETER #536 KIT \$12.90 Wired \$14.90</p>	<p>VTVM PROBES</p> <table border="1"> <thead> <tr> <th></th> <th>KIT</th> <th>Wired</th> </tr> </thead> <tbody> <tr> <td>Peak-to-Peak</td> <td>\$4.95</td> <td>\$6.95</td> </tr> <tr> <td>RF</td> <td>\$3.75</td> <td>\$4.95</td> </tr> <tr> <td>High Voltage Probe-1</td> <td>\$6.95</td> <td></td> </tr> <tr> <td>High Voltage Probe-2</td> <td>\$4.95</td> <td></td> </tr> </tbody> </table> <p>SCOPE PROBES</p> <table border="1"> <thead> <tr> <th></th> <th>KIT</th> <th>Wired</th> </tr> </thead> <tbody> <tr> <td>Demodulator</td> <td>\$3.75</td> <td>\$5.75</td> </tr> <tr> <td>Direct</td> <td>\$2.75</td> <td>\$3.95</td> </tr> <tr> <td>Low Capacity</td> <td>\$3.75</td> <td>\$5.75</td> </tr> </tbody> </table>		KIT	Wired	Peak-to-Peak	\$4.95	\$6.95	RF	\$3.75	\$4.95	High Voltage Probe-1	\$6.95		High Voltage Probe-2	\$4.95			KIT	Wired	Demodulator	\$3.75	\$5.75	Direct	\$2.75	\$3.95	Low Capacity	\$3.75	\$5.75
	KIT	Wired																											
Peak-to-Peak	\$4.95	\$6.95																											
RF	\$3.75	\$4.95																											
High Voltage Probe-1	\$6.95																												
High Voltage Probe-2	\$4.95																												
	KIT	Wired																											
Demodulator	\$3.75	\$5.75																											
Direct	\$2.75	\$3.95																											
Low Capacity	\$3.75	\$5.75																											

For FREE 1956 catalog, mail coupon NOW!



84 Withers St. • Brooklyn 11, N. Y.

Prices 5% higher on West coast and subject to change without notice. ©55

EICO, 84 Withers Street
Brooklyn 11, New York

R-3

Send FREE 1956 Catalog and name of neighborhood EICO jobber.

Name.....

Home Address.....

City.....Zone.....State.....

Occupation.....

Turn page for other EICO ad

1945 to 1955: a decade of Know-How & Value Leadership in Kits & Instruments—over 1/2 million sold to date!

GUIDED MISSILES-

Maintenance

By **SAM F. KENNEDY**

Manager of Maintenance Control
Missile Test Project, RCA Service Co., Inc.

Service technicians are needed for the vast new field of maintaining and troubleshooting missile electronics.

MOST people today know or have heard of the variety and complexity of the equipment that is required for the testing of guided missiles. And it is true that concentrations of electronic and communications equipment dot the test range from Cape Canaveral, Florida, to the West Indies, Puerto Rico, St. Lucia, and Ascension islands. However, when a missile is launched, this equipment becomes part of a tremendous system with a single purpose. All parts either directly or indirectly contribute to the acquisition of reliable performance data. Obviously, reliable performance data depends first on reliable equipment.

Up until the moment that a missile is launched, the operation of the equipment on the range is checked and checked again. Thus, at the precise instant that a missile leaves its launching pad, an uninterrupted flow of data begins. As the missile seeks its altitude and heads down range, it is under remote control at all times. Telemetry equipment in the missile transmits signals that represent speed, altitude, fuel consumption, generator voltages, rocket thrust, receiver signal strength, etc. This data is read im-

mediately on ground control instruments and is also recorded for future reference. Fig. 2 shows a typical ground telemetry station. Although photo-optical instruments record the first stages of the missile's flight, radar pinpoints the position of the missile in space at all times. Data recorders, analog computers, and automatic plotting boards work together to provide accurate position data and position indications. An extremely stable timing signal unifies much of the equipment into a single system; this makes possible the correlation of the recorded data. A multi-channel submarine cable,

EDITOR'S NOTE: The United States Air Force has a vital role in the development of our Guided Missile Program. In order to accomplish its objectives in this field, the Air Force established contracts with the foremost companies in the aircraft and electronics industries to produce missiles and provide administrative and technical facilities at various test centers. Several short-range proving grounds for testing guided missiles were developed at sites within the continental United States. However, these proving grounds were not suitable for testing long-range guided missiles. To provide a facility capable of this, an "inter-continental" missile test range that will extend 5000 miles from southeastern United States to Ascension Island was established. This range is the responsibility of the USAF Missile Test Center, Patrick Air Force Base, Florida. Pan American World Airways has the prime contract with the Air Force to operate the test range. The RCA Service Co., as subcontractor, is responsible for the technical aspects of the range. Thus, RCA plans, engineers, installs, operates, and maintains complete instrumentation and communications facilities related to the testing of guided missiles. This article describes this expansive range, its instrumentation equipment, and the maintenance of this equipment. This month's cover shows a tactical missile immediately after it is launched and an RCA Service Company technician troubleshooting the timing system equipment which is used to help track the missile on its journey.

the longest of its type in the world, links the down-range stations with the launching site at Cape Canaveral. This cable simultaneously carries voice, teletype, telemetry, radar, and timing signals during the missile's flight. After the missile is destroyed by contact



Fig. 1. Microwave dish-type antenna used for both transmitting and receiving the missile tracking signal.

with its target, or returned to the launching site, the raw data is compiled and translated into a form that can be utilized by the Air Force and the missile manufacturer. In the meantime, the equipment on the range is checked and made ready to test the performance of other guided missiles.

Radar Data System

There are many systems of equipment that are used to gather missile performance data. The reader is probably most familiar with the radar-type equipment, since it uses many circuits similar to those found in TV and radio. Fig. 3 is a block diagram of the equipment at a typical radar station. As indicated, there are two sources of information; one is related to timing and the other to radar as will be explained presently.

The radar block beneath the antenna in Fig. 3 represents automatic-tracking equipment that has been especially designed to handle extremely high rates of change. The



Fig. 2. The tape recorders and other equipment shown here record information transmitted to the ground station from equipment in the missile in flight.

basic design is similar to the automatic-tracking radar used at the close of World War II. However, many refinements have increased the sensitivity of this equipment to meet the requirements of supersonic speeds. The radar antenna, which is used for both transmission and reception, is a large paraboloid that has been accurately formed to a fraction of an inch (see Fig. 1); thus, a highly concentrated beam is formed. This beam moves around the target in a conical manner, to make possible the automatic detection and correction of tracking errors. The range, or "A" presentation, has three oscilloscopes which permit long, medium, and short sweep-times. This makes it possible to observe the target without losing sight of the entire presentation. The "PPI," or Plan Position Indicator, provides the familiar map-type indication. The antenna and range units are equipped with large precision potentiometers that furnish information to the analog computer.

Radar equipment units are con-

structed so that each chassis slides forward and then tips to any convenient angle. The technician in Fig. 4 is making a test on one of the tilted chassis; this arrangement makes it possible to troubleshoot and service this equipment with ease.

Troubles in radar equipment can usually be traced to tube failures; however, most tube failures can be prevented if the proper precautions are taken. Periodic adjustments are made to offset the effects of aging components. When controls no longer compensate properly, use of normal troubleshooting techniques often leads to the replacement of faulty tubes or other components. The over-all radar equipment has many moving parts that must be constantly lubricated; thus, oil levels must be frequently checked. Oil-filled transformers and potentiometers must be periodically drained and refilled to guard against moisture. All r.f. transmission lines must be pressurized with dry air to prevent arcing. Because the antenna assembly is exposed to rain and moist air, periodic inspections must be made to detect corrosion.

The receiver is equipped with dual i.f. amplifiers of different bandpass characteristics to permit maximum resolution of targets along with maximum sensitivity of tracking. Due to the inherent instability of the receivers used at radar frequencies, receiver sensitivity must be checked often. Transmitter frequency and power must also be frequently checked. If the radar fails, the maintenance technician must troubleshoot very rapidly because the equipment on the range operates as a system. A missile test may be delayed while some particular equipment is being repaired.

Timing

All missile performance data must be recorded in time, that is, all data must have a common time base. To accomplish this, accurate timing equipment is used. Fig. 3 indicates that the timing signal is fed into the data recorder and the plotting board; however, the timing signal is also used with many other types of instrumentation equipment.

The heart of the range timing system at Cape Canaveral is a highly

stable temperature-controlled 128 kc. crystal oscillator that is synchronized with radio station WWV. The 128 kc. signal is "divided down" by means of bistable circuits until a variety of rates are available for timing purposes. Pulses at the rate of 1, 2, 4, 5, 10, 20, 50, 100, 500, 1000, 8000, and 64,000 pps are available at the outputs of the timing equipment. The 1 pps signal is counted to form a timing code, which is "read-out" each second for identification purposes. This code is recorded in many different ways, but it always represents the same instant in time at each location. The timing signal is transmitted down range by submarine cable so that down-range recordings may also have a common time base. Due to the delay in transit, the signal is transmitted several milliseconds early so that it will reach its destination on time.

The timing equipment is characterized by its many plug-in components, that is, multivibrators, gates, pulse amplifiers, etc. The plug-in circuitry aids the speedy repair of this equipment. When troubles occur in the timing equipment the maintenance technician isolates the trouble by selective monitoring at the console shown on the front cover. In order to detect potential troubles, a thorough check must be made before each missile is launched. Without accurate timing, the recorded missile performance data would be practically useless.

To permanently record the data from the radar equipment, a digital data recorder is used. This equipment encodes information from radar and timing, and punches a tape similar to that used in a teletype machine. The angular position of the antenna in azimuth and elevation, along with range information, is digitalized by means of commutators. This data is stored by memory circuits until it is punched into tape.

The commutators are constructed on the printed (photo-etched) circuit principle; a number of tiny brushes make and break contact in order to form the code. The memory circuits in the equipment consist of many thyatrons, the grids of which are "primed" by the commutator assemblies. The thyatrons are scanned in sequence and operate punches that record the code on tape. These high-speed punches are the most critical part of the equipment. When troubles occur, the many parallel electrical paths through the commutators offer a tough problem to the maintenance technician. Due to the many mechanical features of this equipment the technician must also keep careful check on alignment and lubrication.

The analog computer indicated in Fig. 3 receives potentiometer information in the form of d.c. voltages from the radar; this information represents azimuth, elevation, and range. By using this data, the computer solves for the vertical (altitude) component, the north-south component, and the east-west component. The output of the

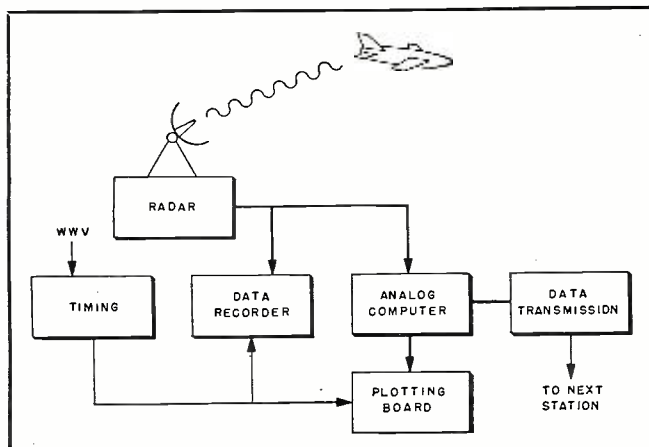

Fig. 3. Simplified block diagram of a radar tracking station showing auxiliary equipment and how it is interconnected.

computer is also in the form of proportional d.c. voltages. Fig. 5 displays the method used to locate a point in space. Note the three solid lines that represent the three components. By changing the value and polarity of these voltage components, any point in space can be indicated. This type of target location is known as the "rectangular coordinate" method. Other methods can be used to accomplish the same thing; however, the rectangular coordinate method offers the simplest approach. No variable angles are involved, and only a single unit of measure is required. These voltages can be plotted against each other in any combination on automatic plotting boards. They can easily be transmitted for short distances over wire, or may be digitalized and transmitted over long distances by cable or radio.

The computer itself is an electro-mechanical device with relatively few moving parts. The actual computation is accomplished by large potentiometers that are physically attached to the radar antenna. The electronic portion of the computer consists of a number of d.c. amplifiers, rack-mounted along with power supplies and other associated equipment. The d.c. amplifiers are extremely accurate; therefore, they require frequent test and adjustment. The power supplies must be regulated within narrow limits, thus, the voltages must be frequently compared with a standard cell. Careful observation and the proper operation of this equipment will usually reveal troubles before they become serious and cause breakdown of the system.

Plotting and Transmitting

One of the outstanding advantages of the computer-radar combination is that the data is immediately available for use; it is said to be in "real time." This means that by plotting this data on an automatic plotting board, the track of the missile or any other object may be observed with no time delay. In order to observe the effects of remote control, these features are very important.

The plotting boards shown in Fig. 6 are instruments used for both observation and recording. This equipment may be located near the radar or it may be operated thousands of miles away. The plotting board is equipped with servo-driven pens that mark the surface of an overlay map; these operate in response to the data voltages developed by the computer. The plotting board marks a trace across the map which indicates the missile's track. Altitude is also plotted by another pen on the same chart. The timing signal is applied to the chart by means of auxiliary pens mounted on the plotting pen assembly. Adjustments can be made for wide variations in chart scale.

The servo amplifiers that drive the pens consist of high-gain audio amplifiers that are similar to the average p.a. amplifier; however, the frequency response is centered around 60 cps.



Fig. 4. Service technician troubleshooting part of a tracking radar operating console. Note the construction of the exposed chassis, designed for speediest servicing.

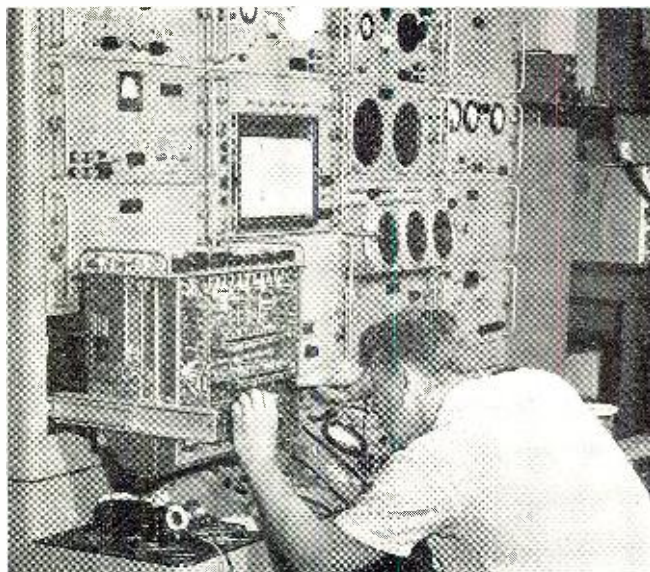

This is necessary to obtain optimum performance with the servo system, and naturally this invites hum. The gain and damping circuits are very sensitive to component changes. Therefore, the maintenance technicians must be especially alert to detect troubles in these circuits and thereby lessen the chance of failure.

Radar information is required at other stations so that each radar can be preset to the missile's position. In this way control of the missile may be passed from station to station without losing radar track. In order to transmit the necessary information, the three voltages that represent the three rectangular coordinates must be digitalized (converted to code) and transmitted. The equipment represented by the data transmission block in Fig. 3, digitalizes the three voltages. The resulting output consists of short tone bursts that are used to modulate the transmitted signal.

The data transmission equipment is built around a bank of precision resistors called the "summing bus." Multi-vibrators, gates, amplifiers, and relays

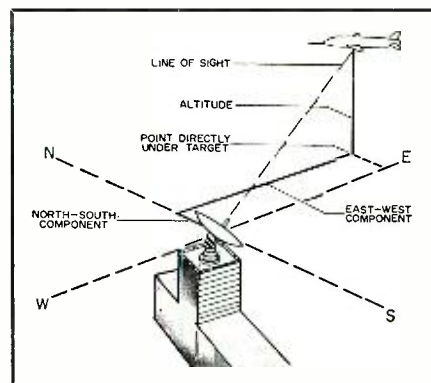
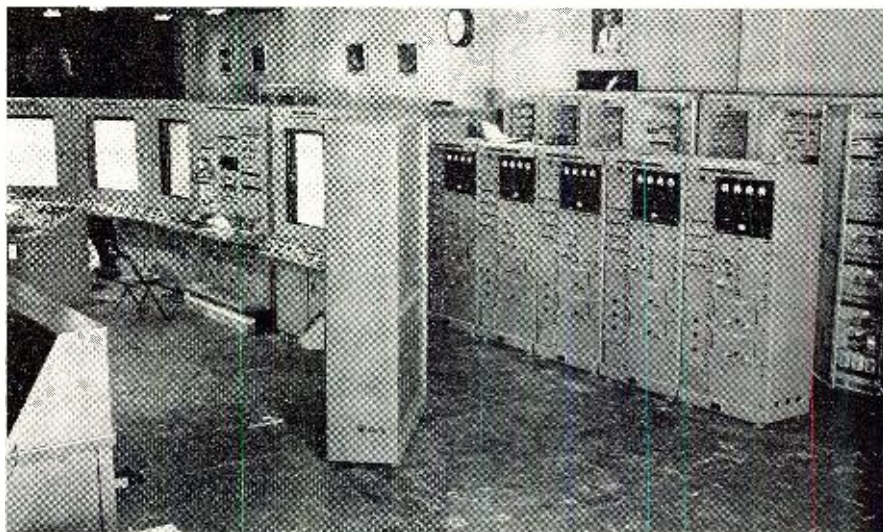

Fig. 5. Shown here are the data components necessary for locating a point in space using rectangular coordinates. These components are represented by d.c. voltages of proportional value.

work together to form the coded groups at a very high rate. The tone bursts are timed and interlaced; they are somewhat similar to a TV sync signal. Irrespective of the mode of transmission, the signal is received, separated, and decoded by sync cir-
(Continued on page 145)

Fig. 6. Central control room of a missile tracking station showing, from left to right, plotting boards, analog computers, and various data transmission equipment.





TV Receiving Tubes

By ROBERT B. GARY

These tubes will appear in the new 1956 black-and-white and color sets. Keep the list for replacement use.

IN REVIEWING the list of receiving tubes released during the past year for use in the new 1956 TV receivers, few really new types of tubes have made their appearance. In general, new type numbers have been assigned to improved versions and slight variations of previously used tubes. The introduction of many familiar tubes with different heater ratings accounts for quite a few new type numbers.

In Table 1 is a list of over 30 new tube types together with their older equivalents and their distinguishing features. Where no equivalent is listed, the tube either combines features of several previously known types or else is electrically different to some degree from older tubes.

The trend toward combining multiple tubes in a single envelope, which was very popular last year, continues, and in this connection there are a number of innovations this year. One remark-

able novelty is the appearance of the 6BC7 triple diode, a 9-pin miniature tube which contains three completely separate diodes with a single heater connection. This tube was designed for and will find its widest application in color TV receivers, where each diode is used as the d.c. restorer for one of the three primary color channels.

Another interesting tube is the 6CG7, a 9-pin miniature type which is an exact equivalent of the well-known octal-based 6SN7. The latter is probably the most widely used dual triode for TV and the availability of a smaller exact equivalent tube will be welcomed.

The 6AZ8 9-pin miniature is remarkable for several reasons. This tube contains a medium-mu triode which can be used as a low-frequency oscillator, sync separator, or amplifier; similar to one section of a 12AU7. The pentode portion of the 6AZ8 features a separate connection for the suppressor grid, permitting the use of an unby-passed cathode resistor without a tendency of oscillation. This makes the pentode section especially suitable for use as an i.f. amplifier in 40-mc. i.f. sections. Another feature of the pentode is the semi-remote plate cut-off characteristic which gives good a.g.c. action without danger of distortion.

Probably the most unusual feature of the 6CM7 is the fact that the two triode sections contained in this tube are dissimilar. Designed to serve as a vertical blocking oscillator and output amplifier with maximum efficiency, one triode section yields a plate current of 5 milliamperes while the other passes 20 milliamperes for full vertical deflection. The plate resistance for the oscillator triode is 110,000 ohms while the output amplifier section has only 4100 ohms plate resistance.

As part of the new batch of tubes expected to be used in color TV sets are a number of high-voltage rectifiers of which the 3B2 is typical. Similar in appearance to the well-known 1B3, this new tube type is distinguished by a maximum inverse plate voltage peak of 35 kilovolts and a peak current of 80 milliamperes.

In Table 1, a number of the new tubes listed have the new 600 milliamper heater for use in series heater circuits. Many of the new tubes which have no previous equivalent also use 600 milliamper heaters. The major feature in all these heaters is the controlled warmup time which allows all the tubes in a series string to heat up together and thereby avoid sudden current surges which cause most burned-out heaters. In replacing tubes in any series heater circuit, the use of the exact replacement tube with respect to heater warmup time is necessary.

For the coming TV year, look for more multi-section miniature tubes and more ruggedized versions of familiar tube types rather than any radically new or greatly different tubes. The one exception to this is the ceramic-type tube for use in u.h.f. tuners, described elsewhere in this issue.

Table 1. Comparison of the new tubes with their equivalents, if any.

TUBE TYPE	EQUIVALENT	DESCRIPTION	TYPICAL APPLICATION	BASE	DIFFERENCE
3A2		diode	high voltage	9 pin	
3A3		diode	high voltage	octal	
3B2		diode	high voltage	octal	
3AL5	6AL5	dual diode	det., a.g.c.	7 pin	600 ma. heater
3BN6	6BN6	gated beam	FM discr.	7 pin	600 ma. heater
3BY6	6BY6	heptode	gated ampl.	9 pin	600 ma. heater
3BZ6		pentode	i.f.	7 pin	
3CB6	6CB6	pentode	i.f., r.f.	7 pin	600 ma. heater
3DT6	6DT6	pentode	FM limiter	7 pin	600 ma. heater
5AN8	6AN8	triode-pentode	i.f., video	9 pin	600 ma. heater
5AQ5	6AQ5	beam pentode	audio	7 pin	600 ma. heater
5AV8	6AV8	triode-pentode	i.f., video	9 pin	basing
5U8	6U8	triode-pentode	r.f., osc.	9 pin	600 ma. heater
5V6GT	6V6GT	beam pentode	audio	octal	600 ma. heater
6AW8		triode-pentode	i.f., sync	9 pin	
6AZ8		triode-pentode	i.f., sync	9 pin	
6BA8		triode-pentode	video, sync	9 pin	
6BC7		triple diode	d.c. restorer	9 pin	
6BC8		dual triode	cascode ampl.	9 pin	
6BH8		triode-pentode	gen. purpose	9 pin	
6BJ8		dual diode-triode	d.c. resistor, sync	9 pin	
6BZ6		pentode	i.f.	7 pin	
6CF6	6CB6	pentode	i.f., r.f.	7 pin	cut-off characteristic
6CG7	6SN7	dual triode	gen. purpose	9 pin	basing, size
6CH7	6BZ7	dual triode	r.f.	9 pin	basing, noise figure
6CM7		dual triode	vert. osc. & output	9 pin	
6CN7		dual diode-triode	det., a.f.c., audio	9 pin	
6CS7		dual triode	vert. sweep	9 pin	
6DE6	6CB6	pentode	i.f., r.f.	7 pin	cut-off characteristic
6DN6		beam pentode	hor. output	octal	
12A4		triode	vert. output	9 pin	
12AB5		beam pentode	audio	9 pin	
12AV5GA	6AV5	beam pentode	hor. output	octal	envelope, 12 v. heater
12B4-A		triode	vert. output	9 pin	
12CA5		beam pentode	audio	7 pin	
25AV5GA	6AV5	beam pentode	hor. output	octal	envelope, 25 v. heater
25CD6GB	6CD6	beam pentode	hor. output	octal	envelope, 25 v. heater

By HERMAN BURSTEIN

Home Tape Recorders—

IN CHOOSING from the many home tape recorders now available, especially in the range below \$400, the purchaser must rely, to a considerable extent, on their respective specifications, assuming these are met. Although specifications do not tell the entire story—sturdiness of construction and quality of parts are reflected in price rather than expressed in quantitative terms—they go a long way toward indicating quality of performance.

Evaluating specifications is not easy. At what point does excellent become good, and when does good become indifferent? Which specifications are of most importance? What use does the customer have in mind?

To facilitate evaluation, it is desirable to sort tape recorder performance characteristics and features into three classes: (1) those essential to high quality performance; (2) those which are generally desirable but of secondary importance; (3) those of a special nature which may be important to the individual user but do not necessarily distinguish the better machines from their inferiors. Evaluation is based largely on use of the tape recorder as an adjunct to a home music system.

Primary Requirements

For normal home use, the specifications of dominant interest are those that relate to distortion, signal-to-noise ratio, frequency response, and mechanical motion. Tape recorder design and construction should stress optimum performance in these respects above others.

A signal-to-noise ratio in excess of 45 db usually is satisfactory for home use. Fifty db or better is excellent. This ratio is based on the relationship in playback between the maximum permissible signal level that can be recorded and the noise (including hum) inherent in the tape recorder. Maximum record level is usually specified as that which produces about 2% harmonic distortion at 400 cps.

At 7.5 ips, the most popular tape speed for home recording, a frequency range out to 10,000 cps is both feasible and satisfactory. In fact, the higher priced machines costing over \$600 often have more moderate treble aspirations than their less expensive brethren. For example, one tape re-

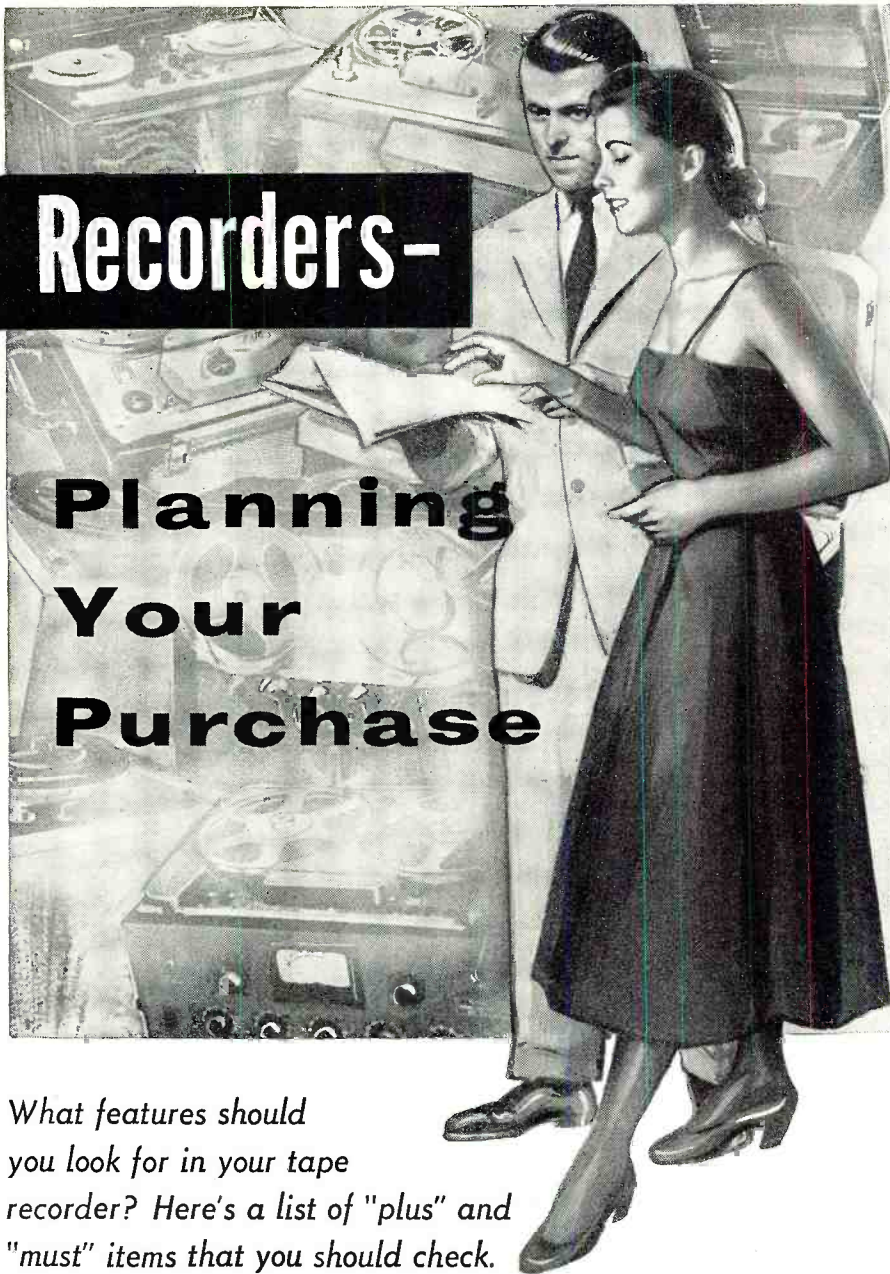

Planning Your Purchase

What features should you look for in your tape recorder? Here's a list of "plus" and "must" items that you should check.

recorder with a price tag of \$1500 specifies a range of only 50-8000 cps at 7.5 ips. The reason is that tape recorder design represents a compromise with respect to frequency range, distortion, and signal-to-noise ratio. Performance can be improved in one aspect only by sacrificing others. Accordingly, the effort to maintain treble response much beyond 10,000 cps at 7.5 ips involves a loss elsewhere. At 15 ips, however, a tape recorder should be capable of providing response to 15,000 cps. On the other hand, relatively few ears can detect a noteworthy difference between a recorder flat to 10,000 cps and one flat to 15,000. Furthermore, in much program material the region above 10,000 cps (or less) contains far more noise and distortion products than pleasurable content.

As far as the low end is concerned, response nearly flat to 50 cps may be considered adequate. The NARTB standard requires no better. Many

high priced recorders specify response to 50 cps, although still others specify 30 cps. Among the home tape recorders in the range under \$400, claims generally range from 30 to 50 cps. It is doubtful if the difference between 30 and 50 cps will be appreciated by many home users. For one thing, a recorder virtually flat to 50 cps also has some useful response at lower frequencies. For another, flat response below 50 cps means better reproduction of motor rumble, from which no recorder is completely free, particularly those in the moderate price class.

Range is not the sole criterion of good frequency response. Equally important is uniformity. Some recorders, in the attempt to maintain response appreciably beyond 10,000 cps, use equalization that produces a peak between 3000 and 8000 cps, resulting in evident treble coloration. Reasonably good reproduction of the original sound can be had if response does not deviate



ESSENTIAL TAPE RECORDER REQUIREMENTS

Table 1

more than ± 3 db over the stated range. Response flat within ± 2 db provides reproduction virtually indistinguishable from the original as far as balance is concerned. A few of the most expensive professional recorders stay within ± 1 db.

These electrical requirements tell only half the story. The other half is told in terms of tape motion, that is, stability, accuracy, and uniformity of speed.

In disc recording, professional standards require that speed be accurate within $\pm .3\%$. This translates into a maximum deviation of ± 5.4 seconds in a 30 minute period. Most professional tape machines are accurate within $\pm .2\%$. To the extent that a machine is used to play back only recordings made on itself, an appreciable departure from correct speed is unimportant, assuming that the speed remains stable from one period of time to another. However, a machine with a serious speed error is unsatisfactory for playing recordings made on other machines, such as commercially recorded tapes.

To assure speed accuracy, as well as stability from one period of time to another, the better machines employ hysteresis motors. The speed at which these motors turn is independent of normal line voltage variations, being governed essentially by the line frequency.

Uniform speed is vital to high quality tape sound. Nonuniformity takes the forms of wow, flutter, and noise. Wow consists of very slow variations, at the rate of eight times per second and less. The resulting rhythmic changes in pitch are easily discernible on prolonged notes such as produced by a piano. Flutter consists of relatively more rapid variations which produce a warbling effect. Extremely rapid variations produce noise, sometimes referred to as frequency modulation noise. The last effect is most pronounced at high frequencies, which take on a coarse, grainy quality. "It has been found that the principal sources of frequency modulation noise are the varying frictional forces acting upon the tape as it passes over the recording heads and guides. This action is similar to that of drawing a bow across a violin string. . . ."

To assure relative freedom from the ill effects of speed variations, it is necessary that these variations be confined to .3% at the very most. The better machines usually specify that wow and flutter (including noise-producing variations) are below either .2% or .1%.

To insure and maintain top quality recording, the following four features are well-nigh indispensable, at least in the writer's view, although there are

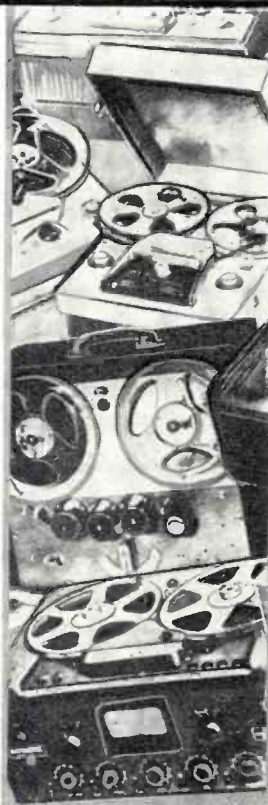

FEATURE	REQUIREMENTS
Signal-to-noise ratio	45 db (good); 50 db (excellent)
Maximum harmonic distortion at 400 cps for recorded signal with specified signal-to-noise ratio	2%
Frequency range at 7.5 ips	50-10,000 cps (good); 30-15,000 cps (excellent)
Uniformity of frequency response	± 3 db (good); ± 1 db (excellent)
Speed accuracy	$\pm .3\%$ or less (good); $\pm .2\%$ or less (excellent)
Wow and flutter	$\pm .3\%$ or less (good); $\pm .1\%$ or less (excellent)
Azimuth	Easily adjustable
Bias	Readily adjustable. Provision for metering
Record treble boost	Adjustable at high end of treble range
Record level meter	Decibel meter type. Located after record equalization

many home tape recorders which lack one, two, three, or all of these features.

1. *Azimuth Adjustment.* Correct azimuth alignment means that the gap of the head is exactly perpendicular to the direction of tape travel. High-frequency response is critically dependent upon azimuth adjustment. A deviation of only a few minutes of arc can spell disaster to the upper range.

Although a machine that uses the same head for record and playback automatically compensates an azimuth error in recording with the same error in playback, this is not true for machines having separate heads. Moreover, even in the case of a machine using a combination head, an azimuth error attenuates treble response when tapes made on other recorders are played. It is therefore essential that a tape recorder provide facile means of orienting the heads, with sufficient vernier to permit very fine adjustment. (Azimuth alignment is usually performed with the aid of one of the readily available test tapes, containing a high-frequency tone for this purpose.)

2. *Bias Adjustment and Metering.* Signal-to-noise ratio, high-frequency response, and distortion depend upon the amount of bias current fed to the record head. Over a certain range, which varies with type of record head and brand of tape, an increase in bias

current increases the amount of signal that can be recorded at a given amount of distortion. Conversely, it decreases the amount of distortion for a given level of recorded signal. An increase in bias current at the same time attenuates treble response. Of course, a decrease in bias current has the reverse effect. For a given head and tape there is an optimum bias setting which provides the most satisfactory combination of signal level (signal-to-noise ratio), distortion, and high-frequency response. To assure top quality recording, one should be able to adjust bias. Equally important, one should be able to meter the bias current, making certain that nothing has happened to change its value and thereby spoil a recording to one degree or another. Machines equipped with a record level meter usually provide a switching arrangement to enable it to be used to measure bias.

3. *Record Level Meter.* The recordist is always faced with the problem of setting record level high enough to afford a satisfactory signal-to-noise ratio, yet not so high as to produce discernible distortion. Most home machines employ a neon lamp or "magic eye" tube to warn when record level causes excessive distortion. However, this type of "go-no-go" indicator has limited usefulness. Far more desirable is the so-called vu meter, which enables one to read record level relative to maximum permissible level. As em-

¹ 3M Company: "Sound Talk," Bulletin No. 18.



Table 2

**"PLUS" FEATURES
OF SECONDARY IMPORTANCE**

FEATURE	REQUIREMENTS
Speeds	At least two, preferably 7.5 and 3.75 ips
Number of tracks	Dual. Single track where editing is important
Heads	Separate record and playback heads
A-B switch	Permits comparison of incoming and outgoing signals
Accidental erasure safeguard	Safety interlock. Record position warning light
Tape start or stop	Less than 1 second
Rewind or forward wind speed	90 seconds or less for 1200 ft. reel
Head wear safeguard	Tape spaced away from heads during rapid wind
Automatic stop	Operates when tape breaks or runs out
Inputs	Minimum of two high-impedance inputs: "line" and microphone. Low-impedance microphone input also desirable
Mixing	Facilities for mixing at least two inputs, with separate gain control for each
Outputs	Output jack preceding internal power amplifier and tone controls, if any. Jack for external speaker if recorder contains own power amplifier. Monitor jack
Equalization	NARTB equalization at 15 ips. NARTB playback equalization available at 7.5 ips
Noise Cancellation	Means for minimizing noise produced in recording
Erasure	Erase head should completely eradicate previous recording

creased playing time at 3.75 ips, with fairly good frequency response and tolerable sacrifices in terms of signal-to-noise ratio and tape motion, this speed is apt to see considerable service in uses where utmost quality is not important. For example, it may be quite adequate for recording conversation, dance music, background music, etc. A standard 7-inch reel of regular tape provides over two hours of playing time at 3.75 ips. By using one of the long-playing tapes, the time can be extended to approximately 3¼ or 4¼ hours.

Each tape speed requires different equalization in order to achieve maximum practical frequency range and uniform response over this range. Therefore a multi-speed tape recorder should provide different equalization at each speed. Some recorders, however, fail to do so, with the result that frequency response suffers at one speed or the other, or both.

Dual Track Recording. Most home tape recorders are equipped with heads that record and play back on slightly less than half the width of the tape. This has the advantage of enabling two tracks to be recorded, on the upper and lower halves of the tape, thereby doubling the playing time obtainable from a reel of tape. Another advantage is that azimuth alignment is less critical and results of misalignment less serious when half-track heads are used. In return, there is exacted the penalty of a reduction in signal-to-noise ratio on the order of 6 to 8 db. However, the design of tape recorders and the quality of tapes have reached the point where it is possible to sacrifice some 6 db of signal-to-noise ratio yet maintain a satisfactory ratio for home purposes. Consequently, unless the home recordist plans to do considerable editing, which is not feasible with dual track recording, he usually gains more than he loses by using a dual-track machine.

Separate Record and Playback Heads. Virtually all home tape recorders selling below \$400 use the same head for record and playback. Although the design requirements for each function are different, this is not a key reason for having separate heads inasmuch as a head that meets the stringent playback requirements is usually adequate for recording. The more important reasons for having separate heads are: (1) This makes possible immediate monitoring of performance and therefore permits easier, faster, and more accurate adjustment of bias, azimuth, frequency equalization, etc. (2) This permits rapid A-B comparison between the incoming signal and tape playback, so as to indicate whether satisfactory recording is taking place.

A-B Switching. In order to facilitate comparison between the sound source and taped reproduction on a machine with separate record and playback heads, the recorder should contain means for switching the output and monitor jacks from the outgoing signal to the incoming one. Comparison may

(Continued on page 152)

played in tape recording, the proper name for this type indicator is decibel meter. (The instrument becomes a vu meter when calibrated to read 0 for a signal which is a specified number of db above the standard reference level of 1 milliwatt across a 600 ohm load.) Usually it is set to read 0 when record level produces 1 or 2% harmonic distortion at 400 cps. Sometimes it is set ahead about 8 db, that is, calibrated to read 0 for a signal 8 db below maximum permissible level. This compensates for the fact that the pointer cannot follow transients with the rapidity of an electronic device, tending to lag by amounts up to roughly 8 db, depending on sharpness of the transient.

(The writer feels that still better protection against over-recording could be had if the vu meter were supplemented by an inexpensive electronic device such as a magic eye tube or neon lamp that responds instantaneously to record level. Such devices would indicate maximum permissible record level.)

Preferably, the record level indicator should be located *after* the equalization circuits used in recording, so that it accurately indicates the amount of audio signal applied to the tape at any frequency. In some cases, however, the meter precedes these circuits, so that it fails to adequately warn of distortion, especially at higher frequencies.

4. *Record Treble Boost Adjustment.* The amount of record treble boost re-

quired to maintain extended and uniform high-frequency response varies with amount of bias and variety of tape used. This is especially true at the upper end of the treble range. The more expensive tape recorders therefore provide means for varying record equalization at the high end.

To summarize, the primary requirements of a home tape recorder intended for high-fidelity use are: at least 45 db, preferably 50 db, signal-to-noise ratio at the 2% harmonic distortion level; flat within ±2 db over a range of at least 50-10,000 cps; timing accuracy of .3% or better; wow and flutter not exceeding .3%; provision for azimuth adjustment, bias adjustment, record treble boost adjustment, and metering bias and record level.

Secondary Requirements

Multiple Speeds. Although it is virtually taken for granted that home tape recorders provide two speeds—usually 7.5 ips and 3.75 ips—this is not always the case. Some models have but one speed. On the other hand, there are a few with three speeds, and at least one with four. For most home service, a dual-speed machine operating at 7.5 ips and 3.75 ips fills the bill.

At the present state of the art, frequency response out to 5000 cps or better is obtainable at 3.75 ips. This is as good as the quality generally available on AM broadcasts. Inasmuch as a tape recorder can offer considerably in-

By
GEORGE C. CHERNISH
 Sylvania Electric Products Inc.

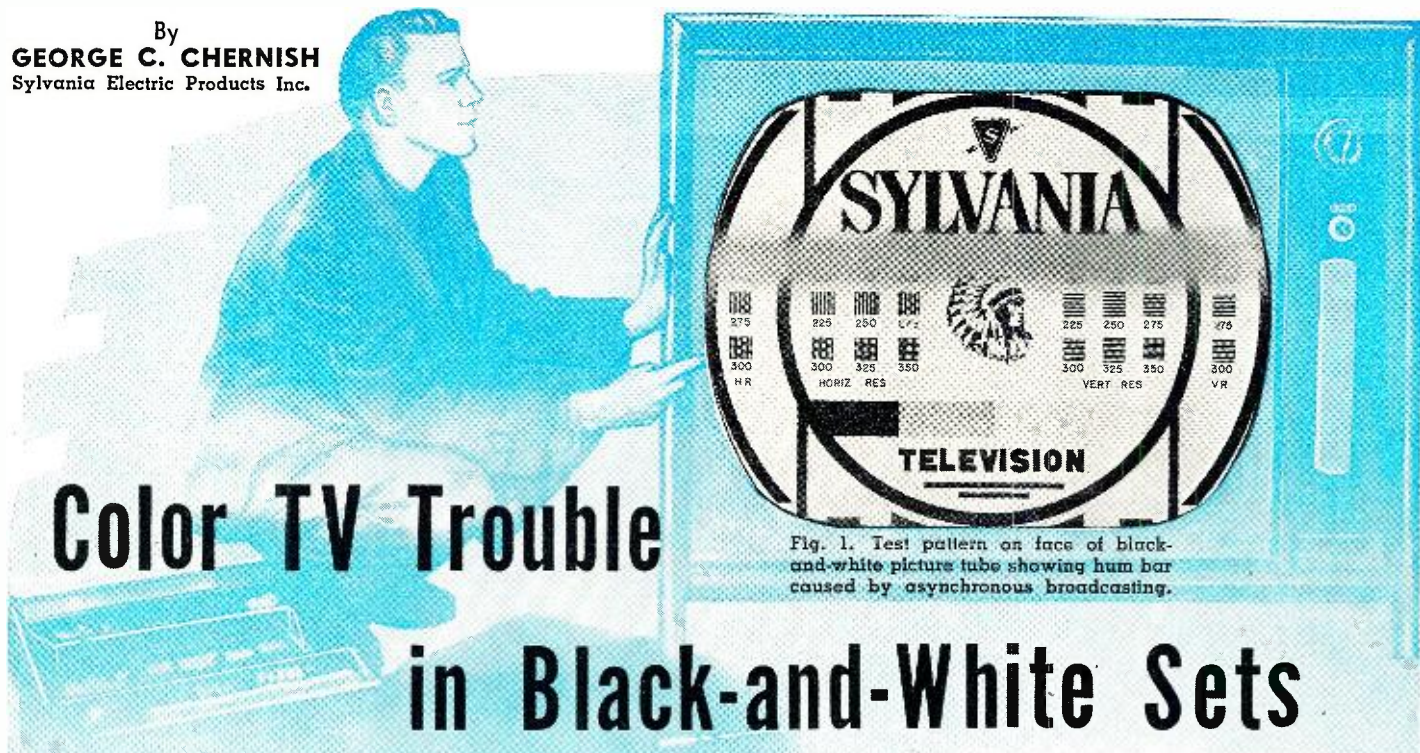

Color TV Trouble

in Black-and-White Sets

*Here is a new problem for the service technician:
 hum bar and weaving caused by color telecasts.*

Fig. 1. Test pattern on face of black-and-white picture tube showing hum bar caused by asynchronous broadcasting.

THE asynchronous operation of color television transmitters confronts the service technician with yet another problem in his long list of receiver complaints. Ever since stations began injecting the 3.58 mc. color burst frequency into their signals, a floating hum bar and/or horizontal weave has made its appearance on many black-and-white TV screens. This is due to the out-of-step relationship between the color transmitter's sweep and the supply frequency.

Today, no receiver leaves the factory unless it can cope with this problem. But what of the millions of sets now in the field? Some, it is true, are hardly affected, depending on the degree of stability of the supply frequency. Others, unfortunately, react most annoyingly, particularly many of the earlier models.

Most stations now transmit their color burst even during monochrome telecasts. With the advent of color, it became necessary to lock the sweep to a crystal, rather than the 60-cycle line. Although supply frequencies today are remarkably stable, they cannot, of course, be perfect. And with the mandatory trend to free-running scan for color transmission, the slightest deviation can cause this asynchronous trouble even in modern receivers, unless they are well-designed.

Perhaps the most prevalent symptom is a dark, horizontal bar moving through the picture—usually upward. In appearance, it is somewhat akin to the standard hum bar, although much

narrower and not quite so black. Fig. 1 illustrates an average condition. Not necessarily confined to monochrome receivers, it may be detected in some of the early color sets as well.

If the floating bar is not accompanied by any horizontal weaving, chances are that the power supply ripple must be driven down to a lower level. This may sometimes be accomplished merely by adding capacity across the output filter. In many cases, however, it will be found that piling on extra capacity does little to eliminate the bar.

Employing the same technique on the input capacitor may also help, but if it doesn't, try tuning the filter choke with a small electrolytic capacitor. Depending on the inductance, a value somewhere between 2 and 10 μ fd. should give results on the average chassis. See Fig. 2. Take care that correct polarity is observed; the plus of the capacitor must always connect to the input of the choke. Various values

Fig. 2. An electrolytic capacitor may be connected across a TV set's low-voltage supply filter choke as shown here, to reduce ripple which causes hum bar.

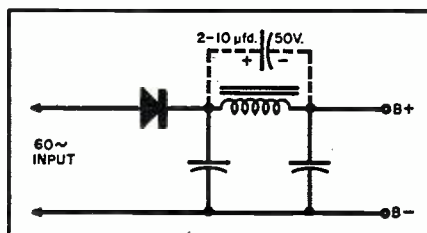

should be tried to obtain optimum results, as evidenced by a lightening or disappearance of the dark bar.

In severe cases, as, for instance, where some of the smaller power companies do not limit their frequency drift to the customary .1%, it will be necessary to drive down the hum to an amazingly low level. This may even call for a small choke—a half-henry or so—in series with the existing filter inductance, in which case the capacitor methods just outlined may be unnecessary. If still required, however, it is preferable that both chokes be tuned as one unit.

Examine lead dress carefully in the vertical deflection stages. While observing the picture, use a probe to reposition the heater wiring in this part of the circuitry. Leads to the hold and linearity controls should be kept clear of any a.c. wiring. As a matter of fact, asynchronous pulses have been picked up from leads running from the rectifier output to filter chokes and capacitors.

Sometimes, in chassis employing the full-wave doubler circuit, the floating bar will darken or fade in sporadic fashion. When this condition occurs on a strong channel, a leaky charging capacitor in the low-voltage power supply is a likely suspect. Theoretically, of course, a very slight leak always exists in electrolytics, with no harm done. But asynchronous operation seems to impose a greater demand for capacity balance between the two charging capacitors.

While on the subject of leakage, heater-to-cathode difficulties should be explored. Tune the picture in and out with the fine tuning. If the bar disappears with the picture, a heater-cathode leak has developed in the local oscillator tube. Although this may be ever so slight, nonsynchronous opera-

tion compels replacement of the tube.

When the tuner is not the source of trouble, try substituting vertical output tubes. A slight heater-to-cathode condition here may cause the trouble in question.

While standard tests exist for the detection of heater-cathode leak, always check this out by tube substitution. Ordinarily all right, some of the accepted degrees of leakage are too great for asynchronous operation. Also, these tests will not detect modulation of the electron stream by the tiny magnetic field from some styles of heaters. Only by observing the picture as tubes are changed can the service technician be sure of his ground.

If the dark bar persists, check the sync tubes next; also the vertical blanking triode, if the set employs one. Finally, the i.f. and video amplifier tubes should be replaced one at a time, in search of interelectrode leaks which ordinarily would not affect receiver performance.

Occasionally, a vertical output tube such as the 6W6 will develop a heater-to-grid leak. At asynchronous operation, this will show up as a faint, narrow hum bar floating through the picture, distorting vertical linearity as it moves from bottom to top. Pulling and stretching the picture severely, this horizontal bar will disappear only by changing the vertical output tube. Before asynchronous operation became so prevalent, a slight heater-to-grid leak was usually tolerable in the vertical amplifier. Today, however, the picture has changed—literally!

In cases where the picture has also developed a slight horizontal weaving motion, examine lead dress in the horizontal sweep stages. Pry the heater wiring around while you observe the picture. Make certain that leads to the a.g.c. and hold controls are not picking up a.c. or asynchronous pulses, as mentioned previously.

Some chassis, notably vertical types, have their filter chokes very close to the picture tube, particularly the first models out. Instances have been found where this inductance had to be relocated so that its nonsynchronous magnetic field, however slight, would not cause horizontal weaving. Only tubes with deflection angles of 72 degrees or less seem to be affected thus, for it requires a fairly strong field to influence a 90-degree beam.

By the same token, power transformers have been found to radiate into the picture tube. As a matter of fact, it can be shown that this condition accounts for most cases of horizontal weaving due to asynchronous operation. Even the 90-degree picture tube is not immune, if the transformer is close. Unfortunately, this is so often the case, especially in earlier models.

Fig. 3 shows a copper flux shield often employed to good effect in minimizing transformer radiation. Formed of flat stock about .020" thick, it should be wound closely around the periphery of the coil, with the endbells

removed. The junction of this single turn must be mechanically and electrically sound.

Fig. 4 shows a transformer, to which such a shield has been added, ready for re-insertion in the chassis. Before making the flux shield, however, it is assumed that the service technician will have extended the transformer leads and tried it out farther away from the picture tube. Sometimes, merely re-orienting the unit will suffice, if this is physically possible. Often, though, it may be a case of asynchronous currents being induced in the chassis, in which instance, of course, the flux shield is mandatory.

There have been cases where stray flux from the power transformer induced a feeble voltage in a nearby vertical-scan transformer. With the transmitter locked to the 60-cycle line, as before color TV, there was no visible interference. However, when the station's sweep equipment went to crystal control, the familiar dark bar began floating through the picture. A copper strap only .010" thick around the power transformer sufficed to kill this interference.

Sometimes the service technician will run across a severe case of transformer radiation—perhaps so great that it almost caused trouble before nonsynchronous operation. Now the copper strap may fall just short of correction. If so, a silicon steel band constructed of ordinary 24-gauge transformer iron will probably be required. Place the band around the transformer (see Fig. 5) so that it can short out any stray flux escaping the copper hum strap. A transformer with both shields employed will cure the worst offenders, no matter how severe.

Some of the 15" color sets require this latter treatment, since they already employ the copper flux shield. Be certain to make the steel band a snug fit, for its effectiveness will be retarded if it slips down and exposes part of the laminations. To be completely effective, it must cover the entire stack.

If a piece of silicon steel sheet is not readily available, a sheet of cold-rolled is better than nothing. Often as not, it will reduce the interference to a tolerable level, particularly the use of a heavier piece. As in the case of the

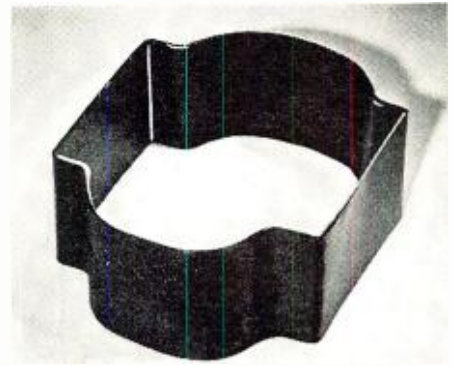

Fig. 3. Copper flux shield, .020" thick.



Fig. 4. Low-voltage power supply transformer shown with a copper flux shield used to reduce its 60-cycle radiation.

copper shield, the joint must be mechanically and electrically sound.

The picture interference discussed in this article will crop up anywhere, without warning, as more and more transmitters convert to color TV. Nothing can be gained by blaming the station; for if its composite signal is examined carefully as it enters the receiver, no hum will be found. Neither will signal distortions of any kind be detected.

The only pertinent criticism which may be levelled at today's mode of transmission is that it demands of the manufacturer a better-performing set. And with asynchronous operation on the increase, and evidently here to stay, it is up to the service technician to improve existing receivers as the symptoms outlined herein arise. —30—

Fig. 5. Silicon steel band shown by itself and in use on a transformer. Such a band is used to help reduce a particularly severe case of 60-cycle radiation.

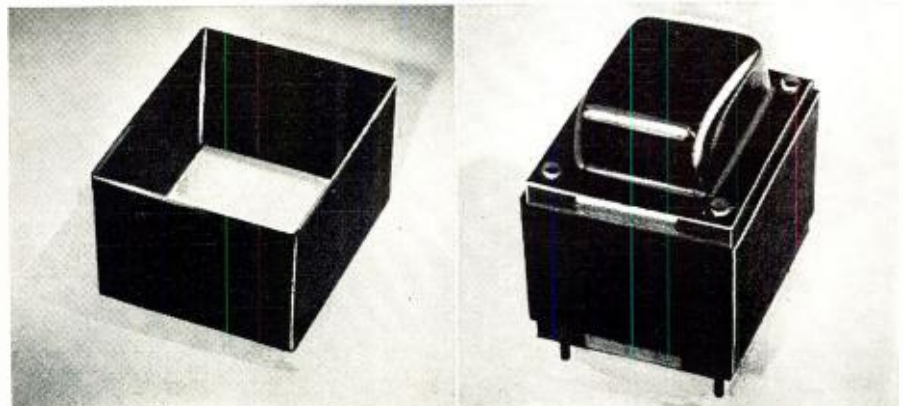



Tube Inventory for Service Shops

By **MURRAY BARLOWE**

Barlowe Television

Tubes on the shelf represent a sizable investment, too much "deadwood" can be dangerous. Here's a "lively" inventory.

WITH the introduction of new tube types every few months, the maintenance of a working tube inventory has become a major problem. In our shop we have found it necessary to set up a perpetual tube inventory system to keep track of what's being used and to let us know when to re-order. By building up a history over a period of months we have developed a "minimum quantity list" which is compared to our tube stock every morning. If a tube type falls below the minimum quantity indicated, it is immediately re-ordered. This list is reproduced here with the hope that it might serve as a guide for the shop owner, in setting up one of his own.

The types and quantities listed are those used in what is probably a typical independent service shop in the New York City area and it would probably have to be modified somewhat for your local area. As an example, there aren't any u.h.f. stations in our area and so it is unnecessary for us to stock tubes such as the 6AF4, 6AN4, etc. On the other hand, we maintain a minimum of 2 each of the tube types peculiar to color sets. We also stock 1 or 2 of each of the new type tubes as they come out and modify the minimum on our list as the demand builds up. Since we also do home and auto radio service you will note that we stock a fair quantity of the types used to service these sets. Our system is far from foolproof—we still find ourselves short occasionally, but the number of times that this happens has been reduced considerably. Bear in mind that our inventory is checked daily. If yours is checked weekly or monthly you would have to increase the minimum quantities accordingly. —30—

Type	Quantity	Type	Quantity	Type	Quantity	Type	Quantity	Type	Quantity	Type	Quantity
OZ4	5	5AU8	2	6BG6	6	6SBY7	1	7F8	2	12SK7	3
1A7GT	1	5BK7	2	6BH6	1	6SC7	1	7G7	1	12SN7	4
1B3	5	5T8	2	6BJ6	1	6SG7	1	7H7	1	12SQ7	3
1H5GT	1	5V6	2	6BK7	3	6SH7	2	7N7	2	12V6GT	3
1CA6	1	6AL5	5	6BL7	3	6SJ7	2	7Q7	1	12X4	2
1N5GT	1	6AL7GT	2	6BQ6GT	10	6SK7	3	7Y4	1	19BG6	4
1R5	2	6AQ5	4	6BY6	2	6SL7GT	3	12AL5	1	19T8	1
1S4	2	6AM8	2	6BN6	3	6SN7GT	10	12AQ5	1	25BQ6GT	4
1S5	2	6AN8	2	6BQ7A	6	6SQ7	3	12AT6	3	25L6GT	5
1T4	2	6AQ6	2	6BZ7	4	6SR7	1	12AT7	6	25W4GT	3
1U4	2	6AQ7	2	6BY5	3	6T8	3	12AU6	2	25Z5	1
1U5	2	6AR5	2	6C4	2	6U5	1	12AU7	10	25Z6GT	3
1X2A	5	6AS5	2	6C5	1	6U8	4	12AV6	3	35A5	2
3Q4	1	6AS7G	2	6CB6	10	6V6GT	6	12AV7	5	35B5	3
3Q5GT	1	6AT6	5	6CD6	4	6W4GT	10	12AX4	3	35C5	3
3S4	2	6AU4GT	2	6CF6	2	6W6	4	12AX7	3	35L6GT	4
3V4	2	6AU5GT	3	6CL6	2	6X4	4	12B4	4	35W4	5
5U4	10	6AU6	10	6CU6	2	6X5GT	2	12BA6	3	35Y4	3
5V4	3	6AV5GT	3	6DC6	2	6X8	3	12BA7	1	35Z5GT	5
5Y3GT	4	6AV6	4	6E5	1	6Y6	2	12BD6	3	50A5	1
3AL5	2	6AX4GT	3	6F5	1	7A7	1	12BE6	4	50B5	2
3AU6	2	6AX5GT	2	6F6	2	7AF7	1	12BF6	4	50C5	2
3AV6	2	6BA6	4	6H6	2	7AG7	1	12BH7	5	50L6GT	5
3CB6	2	6BA7	1	6J5	3	7AH7	1	12BY7	3	50X6	2
3CF6	2	6BC5	10	6J6	5	7AU7	2	12BZ7	2	5642	3
3CS6	2	6BC7	2	6K6	6	7B4	1	12CU6	2	80	1
4BQ7A	2	6BD4A	1	6L6	1	7B5	1	12L6	2	117Z3	2
5AM8	2	6BD6	3	6N7	1	7B6	1	12SA7	2	117Z6GT	1
5AN8	2	6BE6	5	6S4	4	7B7	1	12SG7	1		
5AQ5	2	6BF5	2	6S8GT	2	7C5	2	12SH7	1		
5AT8	2	6BF6	2	6SA7	3	7F7	1	12SJ7	2		

Get a "New Look" into Your Service Shop

Is your service shop as organized and neat as those shown in these photos?

THE pictures of well-organized, neat TV and radio service shops shown on this page were taken in connection with a contest sponsored by the *Almo Radio Company* of Philadelphia, Pa., for the service shops in the area of its 10 stores. The object of the contest was to find the neatest, most efficiently designed, and properly equipped shops in southeast Pennsylvania, central and southern New Jersey, northern Delaware, and northeast Maryland.

Not everyone could enter the contest and benefit from the generous prizes awarded, but all service shop owners can surely profit by improving the appearance of their service shops to match some of those shown here. One important reason for improving the appearance of a service shop is to impress customers more favorably when they visit the shop. A neat and well-organized shop inspires confidence in the company.

However, an even more important reason for having a neat and well-organized shop is the added efficiency and savings in time that such a shop can bring. How would your shop compare with the ones shown here? -30-

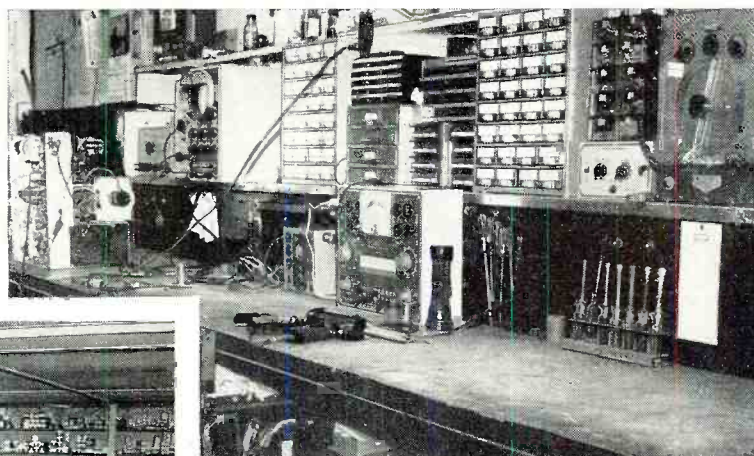
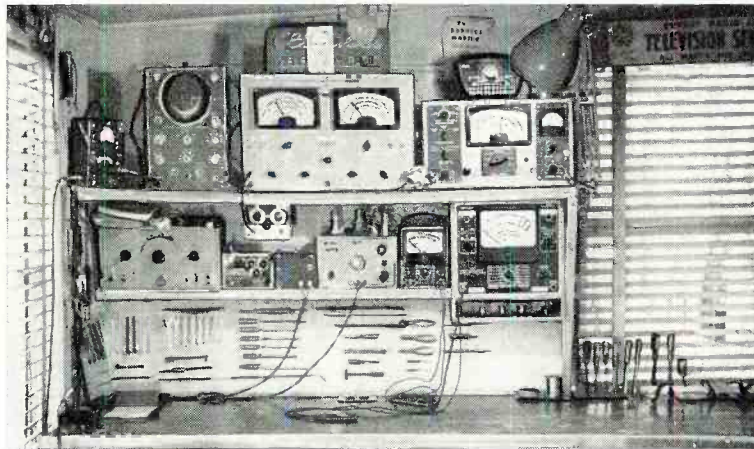

Top right. The well-organized TV and radio service bench shown here is in the independent shop of Fenton Appleby of Millville, N. J. Note the neat array of tools, each mounted exactly in its place. The bench is well lighted and all test equipment is on shelves, leaving space to work.

Above right. This is part of the shop of Bob & Eddie Television, of Vineland, N. J. A minimum of essential test equipment is spread out on the bench; rather, a complete stock of electronic components and tools are kept close at hand emulating production lines, with most of the instruments located at a test center.

Above left. This particular shop impresses all customers immediately with its business-like organization and neatness. This is the Overbrook Radio Co. of Philadelphia, Pa. Each working bench has its own complete set of test equipment and service data; each bench has adequate work space and work area for the technician.

Left. A limited amount of floor space for work benches and set storage is utilized very efficiently by the World Television Service Co. of Philadelphia, Pa., as shown here. Built-in picture tubes and speakers are applicable to TV and radio chassis brought in without their own.

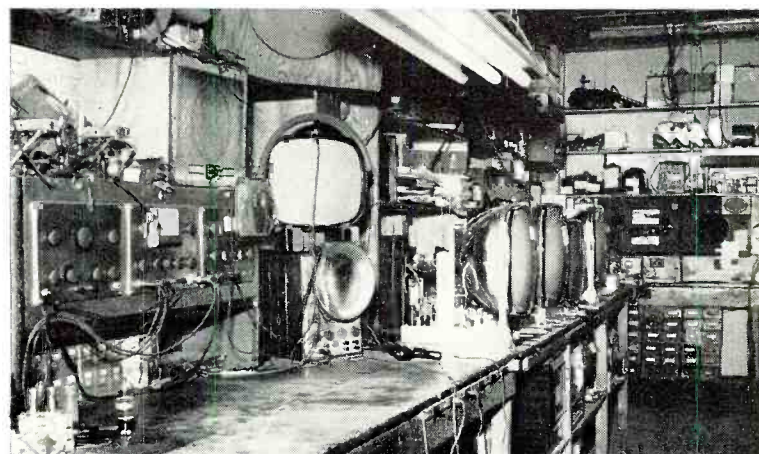

New Tube for U.H.F. TV



Fig. 1. The composite TV picture (right) shows the effect of using a 6BY4 tube (shown above) as an r.f. u.h.f. amplifier. The left half of the TV screen shows snowy u.h.f. reception, the right half is the same channel only now the new u.h.f. amplifier is in use.

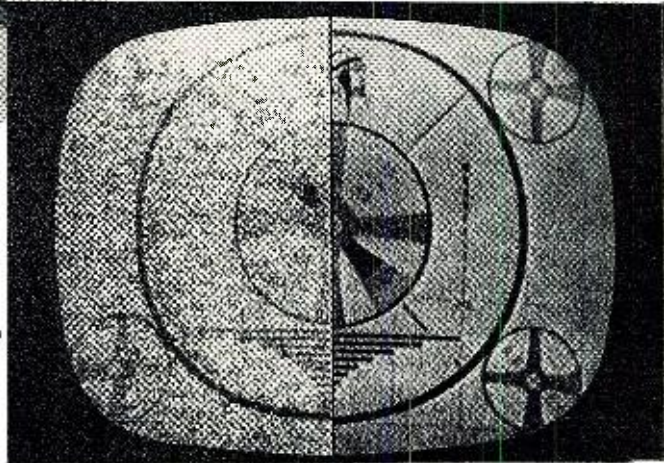

By

D. D. MICKEY, JR. and J. W. RUSH

General Electric Company

*Here's data on a new tube for use in u.h.f. tuners
that may show up shortly in u.h.f.-v.h.f. TV sets.*

CONSIDERABLE improvement in u.h.f. TV reception may be on the way, giving u.h.f. telecasting a better chance for survival. The development of a new type of receiving tube and a tuner in which it can be used as an inexpensive u.h.f. amplifier should result in an entirely new type of u.h.f.-v.h.f. set.

These new sets, now on the drafting boards of many large manufacturers, will use a tiny ceramic tube and the sooner the service technician gets to know it the better. This tiny tube does not look at all like the tubes that the service technician sees in sets today. The 6BY4 (Fig. 1) looks like a small ceramic capsule about $\frac{5}{16}$ of an inch in diameter and $\frac{7}{16}$ of an inch long. It is designed to be mounted in special clip-type sockets, and is used as an r.f. amplifier for both v.h.f. and u.h.f. bands. This tube, about the size of a lead pencil eraser, has characteristics that makes it possible to manufacture a u.h.f.-v.h.f. tuner which will increase the service area of the television station.

At first glance, the 6BY4 doesn't look like a tube at all, but a study of Fig. 3 will show that it has the grid, plate, and cathode of any triode. This tube is composed of alternate rings of ceramic and metal, stacked together and then brazed into one solid, sturdy structure.

At the bottom of the tube are two buttons, through which power is supplied to the coiled heater. Directly above the heater is the disc cathode

supported by a thin metal foil cylinder. This cylinder is just about the diameter of a lead pencil lead. The grid is composed of fine wires, 0.0003 inch in diameter, stretched across a tungsten washer, with a pitch of nearly 1000 turns-per-inch. The anode consists of a stud, welded to a flat metal contact disc, and projecting down into the tube to provide the correct grid-to-plate spacing.

This general type of tube construction is called planar construction, since all of the active parts of the tube elements are in the form of flat planes. This is in contrast to most ordinary receiving tubes, whose elements are arranged in the form of cylinders. Planar construction is used in high-frequency tubes since it provides a means of making a direct low inductance connection to the active elements of the tube. Low inductance internal connections are required at u.h.f. to obtain high gain and good noise figures. This planar construction also provides good isolation of the input of the amplifier from the output, thus reducing the possibility of regeneration or oscillation, and therefore providing stable operation.

The extremely close electrode spacings used in the 6BY4 contribute to the high-frequency performance by increasing the transconductance and reducing electron transit time effects.

The essential characteristics of the 6BY4 are:

Heater voltage—6.3 volts
Plate voltage—200 volts
Cathode resistor—200 ohms

Plate current—5 milliamperes
Amplification factor—100
Transconductance—6000 micromhos
Power gain (at 900 mc.)—15 db
Noise figure (at 900 mc.)—8 db

The noise figure, a measure of the signal-to-noise ratio of the tube, is one of the most important characteristics of an r.f. amplifier since it determines the amount of snow on the screen when the television receiver is tuned to a distant station. A decrease of 3 db in the noise figure of an r.f. amplifier is equivalent to doubling the transmitter power, so it is easy to see that the easiest way to extend the range of the television transmitter service area is to improve the noise figure of the receiver.

The tube socket or holder for this little ceramic tube can take several forms, depending to a great extent upon the particular application. For high-frequency use, the socket inductance and the amount of shielding provided between the input and the output of the circuit become important, as well as the internal inductances that were mentioned earlier. Since the 6BY4 is intended primarily for v.h.f. and u.h.f. service, the type of socket shown in Fig. 4 gives the best results. Directly above the tube is a metal shield that is clamped over the surface of the chassis to aid in the shielding. In this circuit, the tube is used as a grounded-grid amplifier and this shield helps to effectively ground the grid from both top and bottom. This arrangement insures proper low lead inductance and good input-output isolation.

Since the 6BY4 is quite a new tube, very little production circuitry has yet been designed around the tube. To

illustrate how the tube might be used in a u.h.f. tuner, the circuit of Fig. 2 is presented. Fig. 4 is a photograph of a tuner using this circuit. The input or antenna side of the r.f. amplifier is tuned to provide a match to the antenna. The plate circuit or output side of the 6BY4 stage is tuned to provide the proper selectivity for the desired channel. In addition to providing selectivity for the desired channel, the use of the 6BY4 amplifier stage ahead of the conventional crystal mixer stage offers several other advantages. The Federal Communications Commission is beginning to look very critically at tuners, both v.h.f. and u.h.f., with respect to undesirable radiation. The design of the local oscillator and also the input circuitry of the receiver generally determines how much local oscillator signal is fed back into the antenna. The selectivity of an r.f. amplifier, and also its negative "backward gain" (that is, the gain from the plate circuit back to the input circuit), keep oscillator energy at the antenna terminals to a minimum.

An r.f. amplifier for u.h.f. use must provide not only better selectivity and improved oscillator isolation, but also better performance. When one thinks of performance he immediately thinks of a television picture containing less snow. The noise figure of a television receiver means little to the average television viewer, but he does know that he enjoys his TV receiver more when he has less snow to hide his favorite program. Thus, instead of illustrating performance in decibels of noise figure, the photograph of the TV screens in Fig. 1 indicates the typical picture improvement obtained with the use of a microminiature r.f. amplifier. The left side of the test pattern is a photograph of the picture received by a receiver using a conventional crystal-mixer type of u.h.f. tuner. The right side of the photograph is the same signal amplified by a 6BY4 amplifier stage ahead of the crystal mixer. The level of the TV signal sync pulse is the same for both sides of the picture, that is to say, the over-all gain of the television receiver was adjusted to provide exactly the same gain when the r.f. amplifier was added to the receiver. Thus the picture improvement is due entirely to the improved noise figure of the r.f. amplifier stage compared with that of the crystal mixer.

The 6BY4 represents something new and different in the field of tube design and thus will require application and servicing considerations that are somewhat different from those of the standard glass and metal tube types. Used as an r.f. amplifier for both v.h.f. and u.h.f. bands it promises simplicity of design and superior performance. With its high performance capabilities it will find many other applications in addition to television. The general mechanical philosophy of microminiature tubes is in accordance with the new concepts of small, compact printed circuits with solder-in

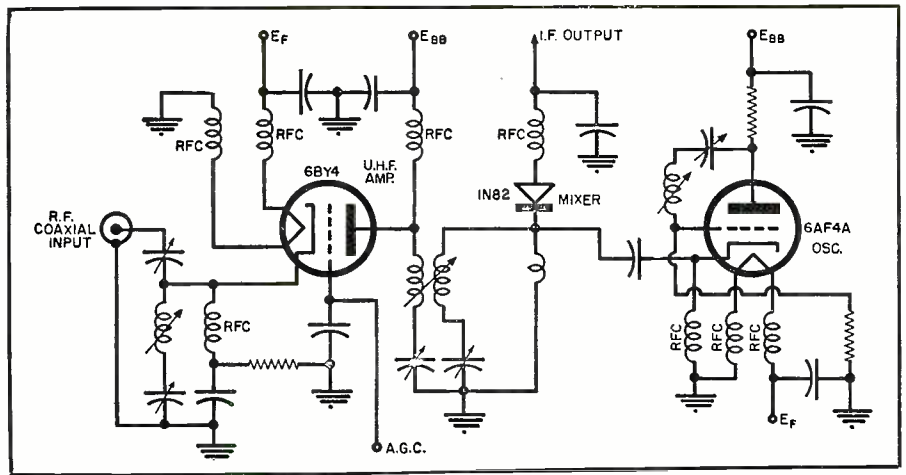

Fig. 2. A u.h.f. tuner circuit using a 6BY4 r.f. amplifier, crystal mixer, and a 6AF4A vacuum-tube local oscillator. The r.f. amplifier is of grounded-grid type.

components, and its rugged construction and heat resistant materials open new applications where heretofore vibration, shock, and high temperature made tube operation difficult. Development of this tube represents a milestone on the road of electronics history.

Although these tubes are radically different in appearance from that of conventional tubes, they actually are subject to some of the same defects, though less frequently. The heater may burn out or cathode emission decrease. The chance of elements shorting is decreased because of the rugged-type construction. As far as gas in the tube causing defective operation, an interesting phenomenon exists. The elements of this tube are made of titanium metal which has the property of *absorbing* gases when hot. Thus, the tube itself is able to eliminate this source of trouble. All of these factors lead to the conclusion that these tubes will not require frequent replacement.

Any experience with ultra-high frequency circuitry indicates two things. One, the circuit element positioning is extremely critical. A slight moving of an inductance or wire from its original position will cause trouble. The second

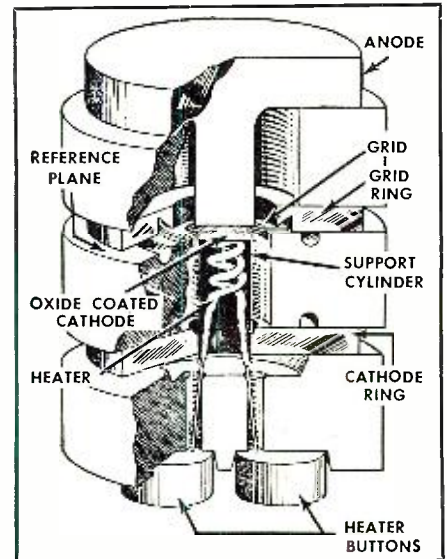
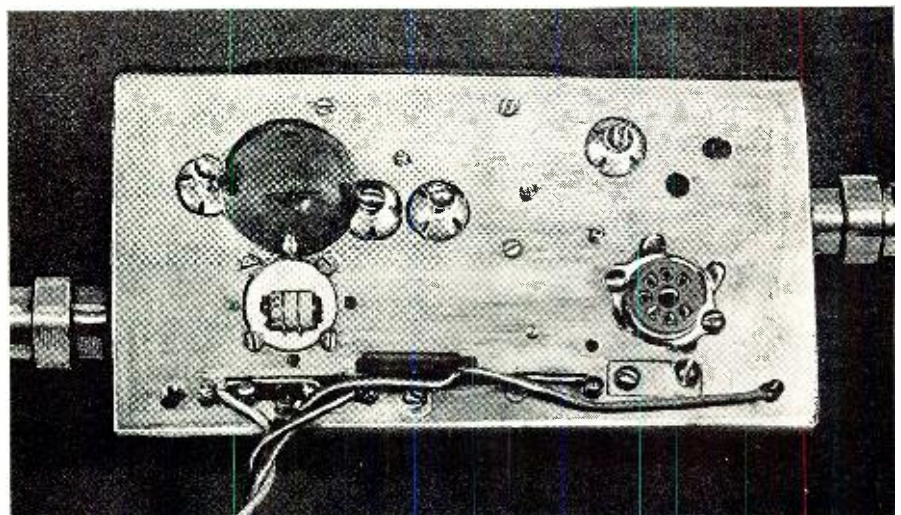

Fig. 3. Cutaway drawing showing the internal construction of the 6BY4.

factor is that the type of components used are relatively rugged and not subject to frequent breakdown. Therefore, the tuners using the 6BY4 will probably be fairly troublefree, but, handle them carefully.

Fig. 4. Developmental model of a u.h.f. tuner using the 6BY4 in a clip-in socket.



Auto Radio Search Tuners

By JAMES A. McROBERTS

The tuning mechanism and circuits of the search-type auto radio tuner are somewhat unusual. Here is an explanation of a typical system with servicing hints.

ARMED with a foreknowledge of the mechanical and electronic requirements, servicing of signal-seeking or "search" tuners is not difficult. These auto radio tuners incorporate an electronic and mechanical system which enables the operator to select the stations he desires by depressing a single bar.

Fig. 1 shows the principal mechani-

cal details of one such device. A power spring forces the planetary arm to move the core bar carrying the cores of the radio tuning coils (for the oscillator and mixer) out of the coils towards the high-frequency position. An arrow between the coils denotes direction of motion. Unless stopped, a lobe of the planetary arm closes the limit switch at the extreme high-fre-

quency position, energizing the solenoid. The solenoid returns the mechanism to the low-frequency end.

Now the mounting spindle carrying the planetary arm also has a gear on it driving a clockwork mechanism which terminates in a paddle wheel. (A friction or worm-gear drive permits manual tuning on many models.) The escapement provides a means of stopping the motion of the planetary arm; as can be seen in Fig. 1, the relay armature engages the paddle wheel blades whenever the relay is de-energized. If the relay pulls its armature away, then the paddle wheel and the entire tuning assembly is free to sweep.

An initial test of this system is to pull the relay stop or armature out of the paddle wheel and then apply power and see if the sweep operates and returns properly. If not, search for the cause. An open solenoid, or a limit switch that does not close, will prevent the mechanism from returning to its starting position. If the mechanism sticks or the spring becomes disconnected, the device cannot sweep. Sometimes the limit switch may be loose in its mounting so the planetary arm lobe cannot close it. Simple inspection will reveal these troubles. A further test is to mechanically manipulate the relay armature to ascertain if the action of the planetary arm can be stopped.

Over-all action of the electronic circuit of a typical signal-seeking tuner may be explained by the schematic diagram of Fig. 2. Assuming that the mechanical and electrical elements are behaving properly, there remains the problem of energizing and de-energizing the relay which mechanically allows the mechanism to sweep or stops it.

Initially, the relay is energized with the first depression of the actuator switch. In this position, the cathode of the d.c. amplifier section of the trigger tube is at ground potential and that tube section conducts. Also, the relay stop (see Fig. 1) is pulled away from the paddle wheel and the tuning mechanism operates.

When a fairly strong station is intercepted, a negative a.v.c. voltage from the a.v.c. tube is fed to the control grid of the d.c. amplifier, decreasing the current through this tube. This so affects the voltages on the elements of the relay section of the tube that conduction in that section is decreased sufficiently to cut out the relay and

(Continued on page 164)

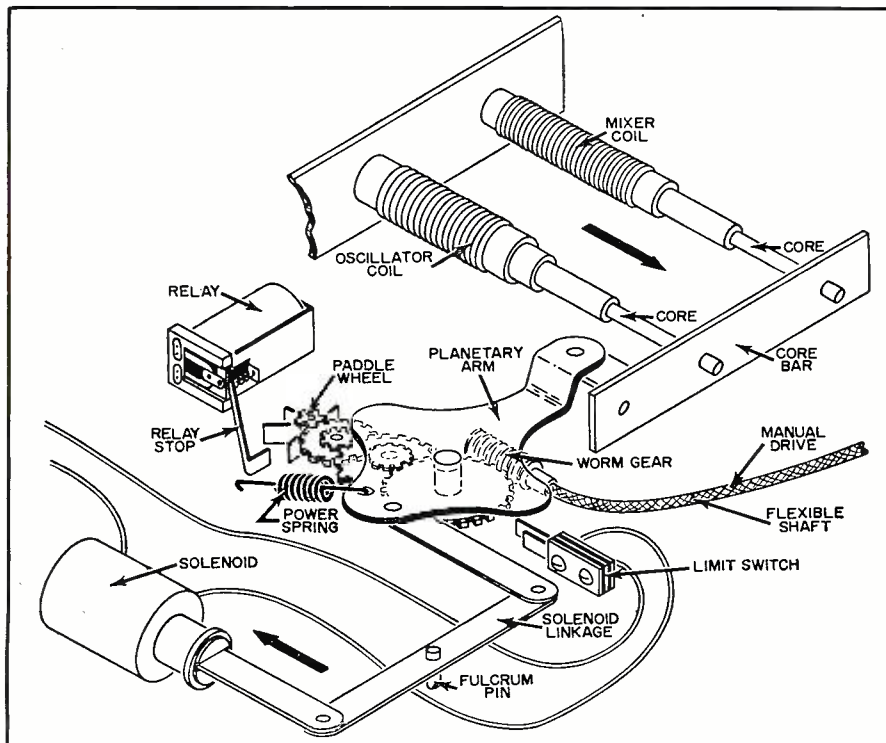

Fig. 1. Mechanical and electrical sections of a typical search-type auto radio tuner. With the relay energized and the armature or "stop" free of the paddle wheel, the planetary arm turns under the force of the spring, changing the positions of the cores in the tuning coils. When a station is encountered, the relay is de-energized, stopping the paddle wheel and the planetary arm. If no station is encountered the arm will move until it closes the limit switch activating the solenoid which pulls the planetary arm back to its starting position.

A Tape System You Can Build



Although this is the commercial version, your home-built unit could be made to look and operate much like this one.

Playback Preamp

By
JOHN L. MacALLISTER
Viking of Minneapolis

AS WAS pointed out in last month's issue, this series of articles will cover the design of a complete tape music system for the home. Starting with a relatively inexpensive tape deck (providing playback only), details will be given on how to add the necessary heads and electronic equipment so that eventually the builder will have complete stereophonic record and playback facilities, for home use, at a relatively low cost.

The Viking FF75 tape deck was selected as the basic unit since it is comparatively inexpensive and provides the requisite facilities for mounting the additional heads, easily and inexpensively. Other tape decks can, of course, be used providing the head equalization is properly adjusted and that it is compatible as far as adding the extra heads.

If the user selects the FF75 monaural playback tape deck, the requirements for playing back recorded tapes are fully met. This unit is equipped with a single head. The length of the head gap is approximately .00015". At a tape speed of 7.5 ips, which is the accepted standard for recorded music tape, the resolution capability of this head extends to at least 14,000 cps without resorting to excessive equalization in the preamplifier.

It might be noted here that with this or any other tape deck, monaural playback is possible using any of the more complex stereo or record-playback multiple head models. The basic FF75 was specified here merely because it is a minimum package for the specific job. If desired, a model FF75-L, incorporating a tapelifter, could be substituted. The tapelifter, as the name implies, lifts the tape from the heads in the "fast forward" and "rewind" modes, eliminating the high-frequency

Part 2. To obtain quality reproduction from your tape unit you will need a playback preamp. There are three choices—either buy or build your own unit or add proper equalizing network to your present preamp. Here are all the details.

chatter caused by the tape passing the head at high speed.

This article covers the playback preamplifier. However, before we get into the technical details, let's review one important point. If playback only is desired, all that is required is a preamplifier incorporating the proper circuit equalization (assuming you have the deck, power amplifier, and a speaker system).

If stereophonic playback is the final goal, two preamplifiers, one for each channel, will be required. If record and playback are desired at the outset, it would not be necessary to use a separate preamplifier as described herein. Instead, the user should build the combined record-playback preamp and bias oscillator that will be described in next month's article.

The Preamplifier

Two, or possibly three, alternatives are provided in the matter of a preamplifier. The first, and possibly most attractive, alternative would be to use an existing phono-preamplifier providing it has an unused equalization position that can be altered to give the required equalization setting.

Let's take, as an example, the man who owns an all-purpose phono-preamplifier which provides adequate gain for tape, but doesn't include correct equalization for NARTB recorded tapes. The prospect of modifying this ampli-

fier for use with tape would certainly be the most attractive of the three alternatives to be suggested.

First, however, let's delineate the requirements for a good tape preamplifier to make sure this phono-preamplifier will be suitable. In playback of recorded music tapes the head output will average approximately 1 to 3 mv. (A head manufacturer is apt to rate his product at 5, or even 10 mv., but this, it must be realized, is with tapes recorded to saturation.) A one-volt output will be required from the preamplifier in order to drive the average music system amplifier to normal output. This, in itself, represents a gain of approximately 50 db. It will be shown also, that at least an additional 25 db of gain will be dissipated in a properly designed equalizing network. Thus, the net requirement is for approximately 75 db of gain before equalization. This gain can be provided by a pentode voltage amplifier, followed by a single triode, or by three triode stages. Two triodes usually fall just short of the mark.

The second possibility would be to construct a suitable preamplifier using the circuitry suggested in the article. All of the components except the transformer (T_1) are readily available at electronic supply houses.

The third, and possibly simplest way, would be to purchase a tailor-made unit. Excellent general purpose amplifiers featuring NARTB tape equaliza-

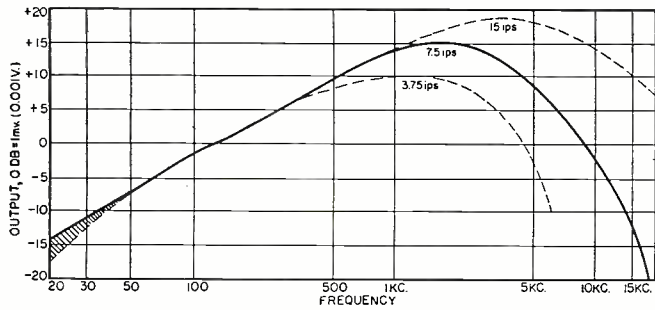

Fig. 1. Record-playback response characteristic of Dynamu 75-1 tape head. (Constant current recording, unequalized playback.)

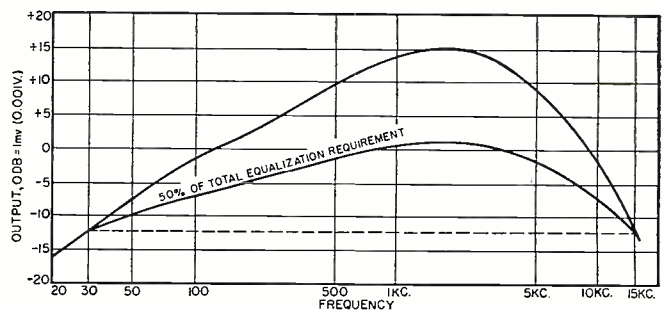

Fig. 2. A typical pre-NARTB equalization characteristic. Since there was no standardization, this varied widely in industry.

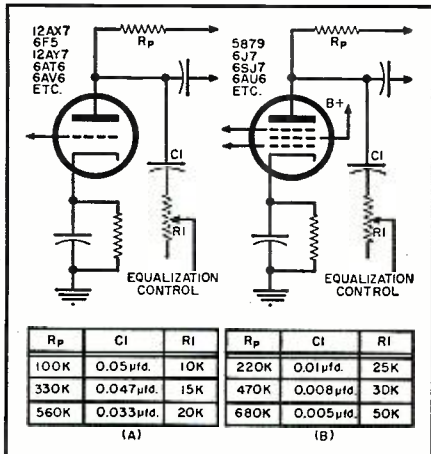

Fig. 3. (A) Equalization for a triode amplifier and (B) for a pentode amplifier.

tion, in addition to the various phono equalization characteristics, are now available. A preamplifier designed expressly for a tape system, such as the *Viking PB60* preamplifier described here, may be purchased for \$24.50 as a plug-in-and-play accessory.

Next, let's look at the equalization characteristic which is required.

The NARTB Standard

Most manufacturers of tape heads provide a response curve which, except for slight departures in frequency range or linearity, has the general conformation shown in Fig. 1. This, it should be pointed out, is the over-all record and playback characteristic of the head, based on *constant current recording on tape, and subsequent unequalized playback of the tape.*

To obtain this curve a sine wave is applied to a given head at constant current and at selected chromatic test frequencies. The output is recorded on tape. The same head is then used without equalization to play back the recorded track. The head output at these several frequencies serves for plotting the curve shown.

This curve at 7.5 ips, it will be seen, can be divided into three segments. It shows a rising characteristic from approximately 30 cycles, a short plateau of approximately flat response, and a descending response characteristic thereafter. Secondary curves (shown dotted) indicate the performance of the same head at 3.75 ips and 15 ips, respectively.

The 6 db-per-octave rise displayed over the first segment is typical of all record-playback heads. The increase results from the fact that with the current held constant, doubling the frequency results in doubling the voltage at the head. This, therefore, is merely a uniformly rising characteristic. The point of departure between representative heads is the plateau at which the response levels off. This can be described as the region of maximum response and is determined almost entirely by the length of the head gap and the tape speed.

The head output then decreases very sharply as the frequency becomes such that the length of the head gap approaches the length of a wavelength on the recorded tape. There are some lesser contributing factors such as losses due to eddy currents, I^2R losses, etc., but, in general, this falling off

in response can be termed a "wave-length" loss.

One other irregularity or loss appears on this curve, *i.e.*, the falling off below approximately 50 cycles. This is customarily referred to as a "wrap-around" loss. It begins at the frequency where the length of a wavelength on the recorded track exceeds the length of the head itself. This too can be compensated for, but may well be ignored, since it represents only a negligible loss at the commonly usable audio frequencies above 30 cycles.

Prior to the adoption of the NARTB standard, tape recorder manufacturers solved the problem of equalization in accordance with their own individual preferences. The most common practice was to halve (approximately) the equalization requirement, as shown in Fig. 2, attenuating the middle range by a factor of fifty per-cent in recording and the balance during playback. This entails a minimum of circuitry; the same equalization network suffices for both recording and playback. The disadvantage, however, is that such a system provides a smaller dynamic range, since it does not provide for pre-emphasis at the higher frequencies to compensate for the decreasing retention characteristic of the tape itself at these frequencies. As a result, the tape is likely to be overloaded at the lower frequencies in an effort to obtain sufficient high-frequency response.

The NARTB standard has been thoroughly covered in the article "Why the NARTB Curve for Magnetic Tape?" by W. E. Stewart (June 1955 issue) and is too involved for explanation here, but briefly it amounts to this. It was decided that the optimum means would be to compensate for the "wave-length loss," as well as the high-frequency deficiencies of the tape itself during the recording process, and to compensate for the 6 db-per-octave rise to the region of maximum response during the playback half of the cycle. This provides flat response for the over-all record and playback cycle, and at the same time provides maximum dynamic range.

Actually the current NARTB standard, as established, applies only to tapes recorded at a speed of 15 ips; however, at 7.5 ips it is only necessary to increase the pre-emphasis slightly at frequencies above 3000 cycles.

In the preamplifier, therefore, it is necessary only to compensate for the

Fig. 4. Response characteristics of PB60 preamp. Broken lines indicate range of unit.

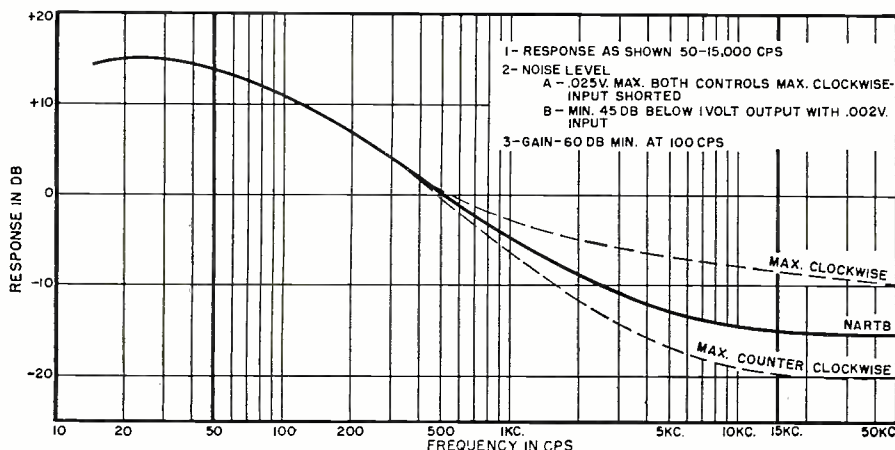

6 db-per-octave slope from 30 to 2500 cycles. The preamplifier response characteristic which accomplishes this function is shown in Fig. 4.

Equalization for Existing Units

The actual circuitry employed in various commercial preamplifiers is too varied to permit individual treatment, but if schematics are available for reference it is not difficult to trace the circuit for a given switch setting, remove existing equalization components, and replace them with an RC network having the proper values.

Practically all commercial preamplifiers of recent vintage fall into one of two types; amplifiers employing triodes (or double triodes) such as 12AX7, 6F5, 12AY7, 6AV6, or 6AT6 tubes, or amplifiers employing pentodes such as the 5879, 6J7, or 6AU6 tubes. Fig. 3A shows the RC network required to provide a 6 db-per-octave equalization characteristic using triode amplifiers, and Fig. 3B shows the RC components required for pentodes. The tables provided beneath these diagrams indicate the correct component values for given values of plate load resistors commonly used.

It should be pointed out that if an inverse feedback loop is employed, the effect of an equalizing network inserted within that loop is not practical unless the feedback loop itself is re-designed or removed. Similarly, in some preamplifiers equalization is derived by means of frequency discriminating feedback loops. In such cases it is more practical to build the preamplifier described here than to attempt redesign of the equalization circuit.

Building a Preamplifier

The preamplifier circuit, shown in Fig. 6 and described here, is equivalent to that of the *Viking* PB60, designed for use with the *Viking* decks and, consequently, the "Dynamu" heads. However, since the equalization is variable over approximately a 14 db range at 10,000 cps, the same circuit can be used satisfactorily for any of the currently-available heads.

A type 5879 pentode amplifier was selected as most suitable for the first amplifier stage because of its inherent low noise level and freedom from microphonics. Following this pentode amplifier stage, one section of a 12AX7 double triode is employed as a voltage amplifier. The other section of the 12AX7 tube is used as a cathode-follower output stage.

Construction

Since the preamplifier must operate from a very low signal level and provide high gain, good design and careful construction are essential. The input circuitry must be completely isolated and shielded from the a.c. components. One hundred per-cent shielding must be employed if the preamplifier is to operate satisfactorily in proximity to the tape deck.

A photograph of a *Viking* PB60 pre-

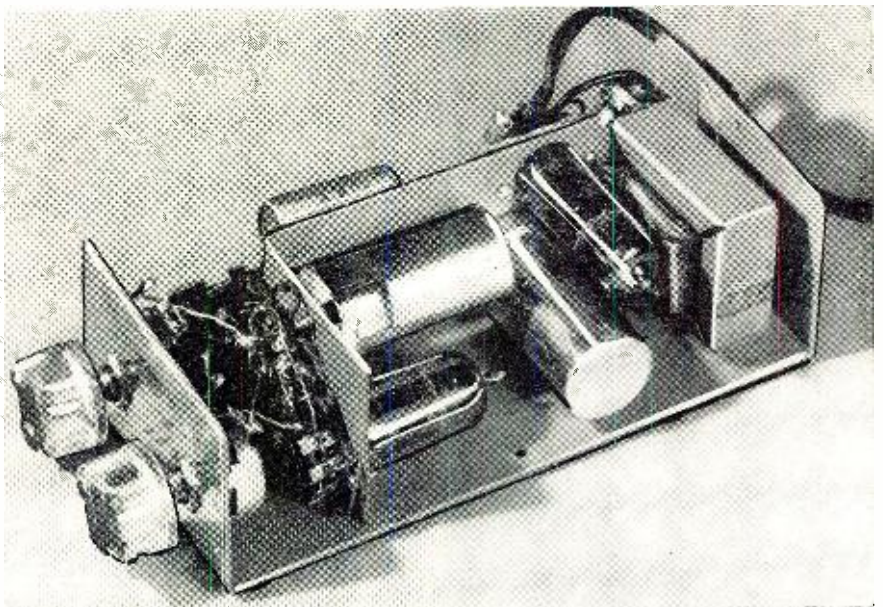
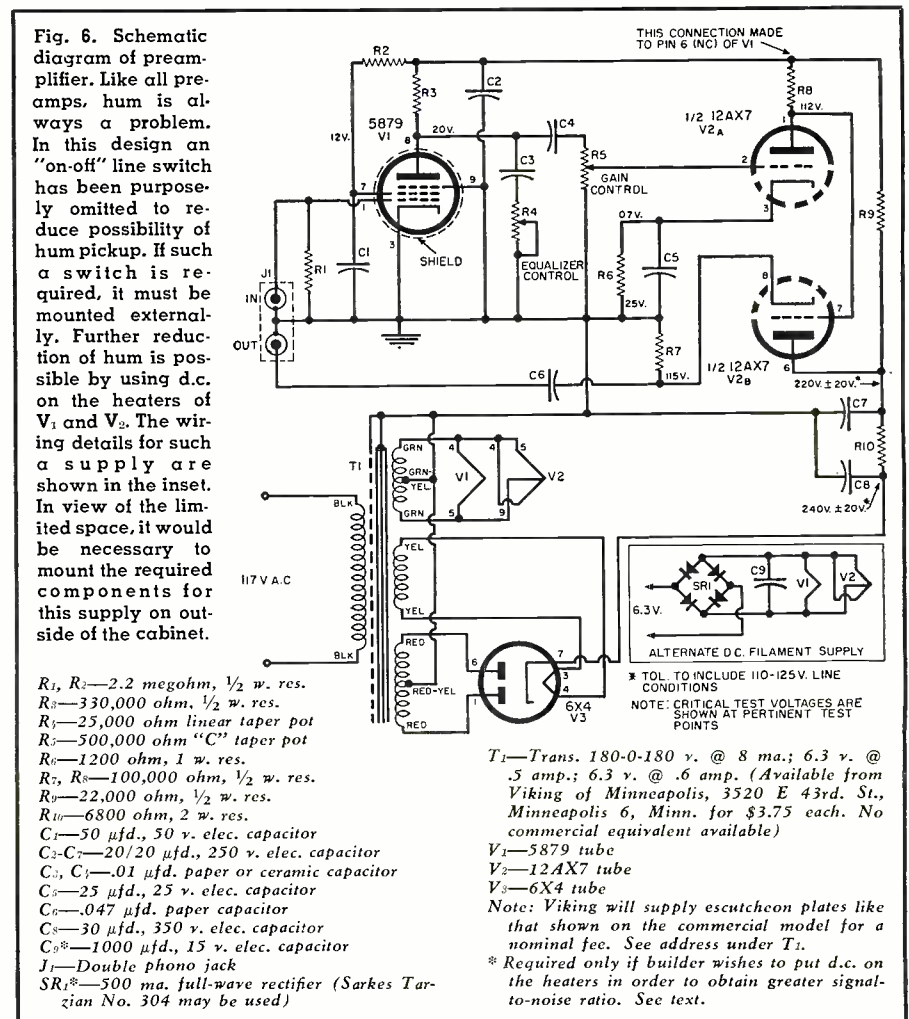

Fig. 5. Internal view of the commercial version. Your home-built unit can duplicate this design but, as suggested in article, the housing should be made larger.

amplifier with shield cover removed is shown in Fig. 5. Individual shield and chassis elements are shown in Fig. 7. A conventional stock-chassis and panel layout could be used as well in duplicating the circuit; however, the metal work shown here is not extensive and the design should be given considera-

tion by the home-builder. The design was dictated primarily by the requirement for a minimum size package, total shielding, and, of course, adaptability to economical production. The home-builder using this same design would do well to "let-out" the dimensions (Continued on page 159)



Tuning and Loading

Two-way

FM Mobile Transmitters

By
JACK DARR

The current widespread use of two-way radio equipment makes the servicing of such gear profitable for the technician.

IN THE maintenance of two-way radio communications equipment, the limiting factor governing maximum coverage of the entire system is the transmission range of the mobile units. No matter how powerful the base station transmitter, two-way communication cannot be accomplished if the mobile units cannot "get in." With the dual handicaps of unpredictable terrain and comparatively inefficient antennas, these transmitters must be operating at peak efficiency if any results at all are to be expected.

Proper tuning and loading of the transmitters is absolutely essential. Many technicians, accustomed only to receiver servicing, have encountered difficulty when taking over maintenance work on this type of system. The actual tuning of the transmitters, bringing the different stages into resonance, is not too difficult. Test jacks are provided in all makes of commercial transmitters, so that each stage may be tuned to peak efficiency, if the proper test equipment is used. The actual loading of the final stage, while comparatively easy if the proper test equipment and techniques are used, is another matter.

The transmitters usually comprise a crystal oscillator stage, generally a Pierce, a modulator for FM, and enough frequency-multiplier stages to reach the assigned operating frequency. Jacks and test points are provided in the grid returns of each stage, so that grid current may be measured. (Refer to the author's article, "Metering Circuits for Tuning V. H. F. Transmitters," RADIO & TELEVISION NEWS, February, 1956 issue.) Tuning these is merely a matter of adjusting each

stage for a peak reading. This procedure differs somewhat in detail from set to set, according to the manufacturer, but basically, all are identical. With the voltage amplifier stages all set up to deliver a maximum signal to the final grid or grids, all that remains is to get the maximum amount of power out into the antenna itself.

This is fundamentally a matter of matching the antenna's resistance, impedance, and capacitance, etc., to the final stage of the transmitter, so that maximum power will be transferred to the actual antenna to create the maximum radiated field intensity around the rod. For the basic principles of this process, see any good text on fundamentals, such as the "ARRL Handbook." Loading details are included in the instruction manuals which accompany each transmitter. It is best to follow these as closely as possible with respect to procedure. They *must be* consulted for location of the various adjustments.

Fig. 1. Typical plate current for the final stages. As plate coil is tuned across resonance, plate current falls, then rises to original value. Correct tuning is at the bottom of the dip, as explained in the article.

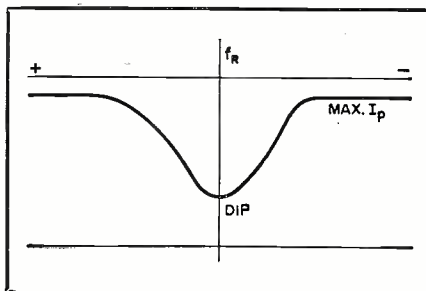

Be very sure to check the instruments specified for the measurements: failure to do so can lead to trouble, especially if several different makes of equipment are being serviced. *Motorola*, for instance, uses a 50- μ a. meter to check final plate current, with a very small (1-ohm) shunt: *RCA* and *G-E* measure the final plate current directly, using a 300-ma. meter. If the 50- μ a. movement should be connected into the circuit in place of the 300-ma. meter—no comment. The manuals will also give the proper value of plate current for rated output. *RCA's* 60-watt mobile transmitter, with a pair of 807's for instance, draws 200 ma. at rated output.

To make the final loading adjustment, after all previous stages are tuned, first turn the "Tune-Operate" switch, if one is provided, to "Tune." (This lowers the plate voltage applied to the final stages, preventing damage to the final tubes during adjustment.) The antenna should be connected. Turn the "Ant. Loading" adjustment, which may be a variable capacitor or a small link of only a half-turn, into its farthest "out" position, minimum loading. This removes the load from the final stage, making the dip easier to locate.

Now, the final "tank" coil must be brought into resonance with the signal being fed to it from the driver stage. As this coil approaches resonance, the plate current will show a decided drop until, at resonance, the current should be a minimum. (See Fig. 1.) This is because the signal is causing the plate tank coil to have a heavy circulating current and the impedance is reaching a maximum. This dip is the point of resonance. Normally, this reading will be approximately half of the maximum current. (Full load current, 200 ma., dip about 100 ma.)

Continue tuning past the dip, until you are sure that the actual dip has been found. The current will rise rapidly on both sides of the actual dip. If no dip is found, go back and recheck the tuning of preceding stages. It is possible, in some cases, to hit the wrong harmonic in a frequency-multiplier stage, which will give you some readings on following stages but throw the final signal far out of range of the final tank coil. While this is not a common trouble, still the possibility of its occurring should not be overlooked. Check the signal on the final grids for equality if the transmitter uses push-pull output. If too far off, rebalance, by adjusting the trimmers provided. A difference of over three or four units is too much: re-adjust. Now, slowly advance the "Ant. Loading" adjustment, bringing the link closer to the tank coil, or closing the capacitor. The plate current should rise. Next, recheck the dip in the plate current: it should still be there, but should be a good bit "shallower" than before. Turn the "Tune-Operate" switch to "Operate" and adjust the current for the rated value, such as the 200 ma. mentioned previously for the two 807's.

(Continued on page 158)

Transistor Servicing Precautions

By MILTON S. KIVER*

THE transistor exhibits a curious combination of ruggedness and fragility. It is, for example, far more rugged physically than even the most powerfully-built vacuum tube, capable of withstanding centrifugal forces with accelerations as high as 31,000 *g* and impact tests as great as 1900 *g*. These are far in excess of the forces which will completely shatter any vacuum tube. On the other hand, a transistor is a fragile device with respect to heat or to the application of d.c. biasing voltages possessing the wrong polarity. It is important, then, to be familiar with the physical handling limitations of transistors, so that transistor equipment can be serviced with a minimum adverse effect either on the transistors themselves or on the miniature components with which they are often employed.

Tools

Probably the first step to take in preparing yourself for transistor work is the acquisition of the proper tools. Since transistors and their associated components are extremely small in size, conventional-sized tools are frequently unsuitable for effective use. To supplement them, purchase the smallest cutting pliers and needle-nose pliers available. Also include short and long shank screwdrivers having narrow blades. Another useful device is a soldering aid, one end of which has a notch for gripping wires while the other end comes to a fine point for probing or cleaning away solder from small openings. Fig. 2 shows some small tools suitable for work with transistors.

Another change required by the transistor is the use of a small, low-wattage soldering iron (or pencil) possessing a narrow point or wedge. Wattage ratings on the order of 35 to 40

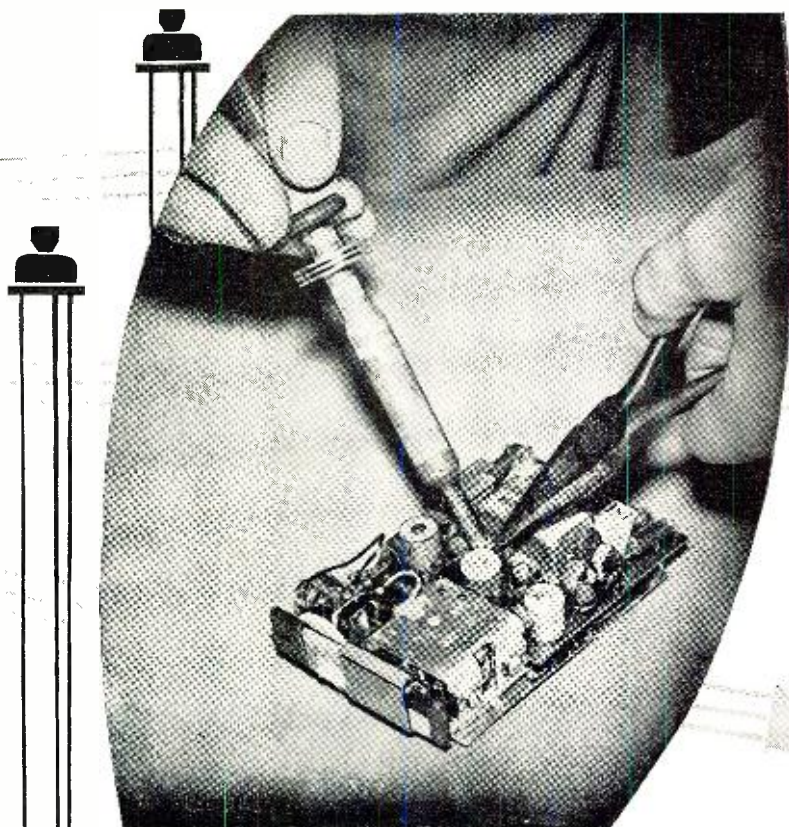

Fig. 1. To provide the transistor with maximum protection while it is being soldered or unsoldered in a circuit, grasp the terminal lead tightly with long-nose pliers positioned between the transistor and the lead end.

More and more, portable radios are being transistorized; their servicing is profitable, but note these precautions.

watts are satisfactory; anything larger than this could damage the transistor while it is being soldered into the circuit. (The same low-wattage iron is required also for the printed-circuit wiring of a transistor receiver.)

To provide the transistor with the maximum protection while it is being soldered or unsoldered, it is good practice to grasp the terminal lead tightly with long-nose pliers positioned between the transistor body and the lead end. See Fig. 1. With this arrangement, any heat traveling along the wire will be shunted away from the transistor housing. Keep the pliers on the wire for a short time after the iron has been removed to make certain that all the heat has been dissipated. It is also good practice to provide such a heat shield when other wires are being soldered to any terminal lugs to which transistor leads are attached.

Two helpful rules to follow are to keep the transistor leads as long as possible, consistent with the space available and the application, and to get whatever soldering that has to be

done over with as quickly as possible. The 60/40 type low-temperature rosin core solder is probably best.

In some instances, transistors are constructed with leads which are stiff enough to permit plugging the transistor into a specially constructed socket, such as the one shown in Fig. 3. In such cases, of course, soldering is no problem and the only precaution to observe is to remove the transistor from the socket before the soldering iron is brought into contact with any of the socket terminal lugs.

As a final word concerning the use of tools on transistors and their associated miniaturized components, always remember that because the latter are small, their connecting wires are quite fragile. Handle these wires carefully and gently, both when the part is being installed and when it is being removed.

Battery Potentials

Two factors combine to make transistors particularly sensitive to applied bias voltages. First, there is the fact that the emitter-base junction is biased in the forward or low-resistance direction and the impedance of this circuit,

* Author of "AM-FM Servicing Short Cuts" (Howard W. Sams & Co.), "TV and FM Receiver Servicing" (D. Van Nostrand Co.), and other books.

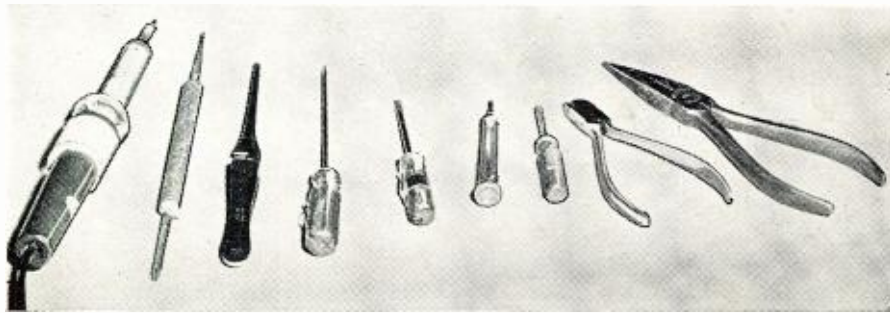

Fig. 2. Representative types of tools for transistor radio repairs. The soldering iron is comparatively low wattage (35 watts) suitable for work on printed wiring.

under these conditions, is extremely low. Any voltage in excess of the required value could cause so large a current to flow that the resultant heat would permanently damage the transistor. The correct operation of a transistor—any transistor—is intimately tied in with the maintenance of its crystal lattice structure and the distribution of certain impurity atoms throughout that structure. If enough heat is generated to distort the crystal structure, the effectiveness of the transistor to function as desired is seriously undermined. This is the reason for the oft-repeated warnings against applying too much heat or permitting the unit to become too warm during operation.

The second factor that makes transistors sensitive to applied bias voltages is the extremely minute dimensions of the several elements and their very limited heat dissipating ability. Collector current is important in this respect because this current, passing through the relatively high collector resistance, develops a certain amount of heat. If this heat, added to the ambient heat at which the transistor is operating, exceeds the maximum limits of the transistor, behavior becomes erratic. This is why the maximum collector dissipation is always specified at a definite ambient temperature. If the surrounding temperature is higher than specified, the collector dissipation rating must be reduced proportionately. This is known as derating.

The maximum safe value of collector voltage is also important, since too high a value will lead to a reverse current breakdown. The point at which this occurs is known as the Zener voltage.

Thus, because of the foregoing limitations, the value and the polarity of any voltages applied to the circuit must be scrutinized carefully. Make certain first that you have the right

voltage, then check polarity before final connection is made to the circuit. If you are at all in doubt about the latter point, check the type of transistors being employed. The *p-n-p* units require negative collector voltages and positive emitter voltages, both taken with respect to the base. In *n-p-n* transistors, the reverse situation holds.

Before the battery is connected to the circuit, the various transistors should be firmly in place. Never insert or remove a transistor when voltages are present. This is designed to prevent the appearance of surge currents which, if they are powerful enough, can permanently damage a transistor. Always remove the voltage first. If you are doubtful about a repair, insert a current meter in series with the collector circuit and then use a potentiometer arrangement to gradually apply the collector voltage. If the collector current begins to exceed the specified maximum, you know something is at fault.

To men who have gained all of their radio and television experience on vacuum-tube circuits, all of these precautions may appear somewhat excessive. However, experience has revealed that they are most definitely required. Transistors are extremely sensitive to heat and anything that develops heat, such as current flow, must be watched with a wary eye.

Another source of potential danger lies in the signal generators which the technician uses to service radio and television systems. When a signal is injected into a transistor circuit, start with a very low amplitude signal and gradually increase the generator output until the desired indication is obtained. Never inject strong signals into a transistor circuit, particularly a low-level stage. Frequently, indirect rather than direct coupling methods of signal injection are advisable. For example, clip the "hot" output lead from the

generator to the insulated body of a nearby resistor or capacitor. The signal will then enter the circuit by radiation and capacitive coupling. This approach is widely practiced in television receiver alignment when a marker signal must be brought into the system without swamping the sweeping signal.

It has also been suggested that signal injection can be achieved by connecting the output of the signal generator to a suitable coil and then rotating the axis of the coil until the desired signal is developed in the receiver. (The signal is brought into the circuit by inductive coupling.) In using this method, the radiating coil should be geared to the signal frequency. That is, a high inductance coil should be used for low frequencies and a low inductance coil for high frequencies. See Fig. 5.

The sensitivity of a transistor to surge currents should be borne in mind when a voltmeter is being used to check voltages at various points in a transistor receiver. Due to the closeness with which components are placed, it is easy for the probe tip to accidentally touch two closely-spaced terminals if the technician is not exceptionally careful. This simple slip may result in battery burnout, or be responsible for a current surge through the transistor as, for example, when the probe makes simultaneous contact with the collector and emitter electrodes. Extra emphasis is placed on this precaution because of the ease with which it can happen. In vacuum-tube circuits, similar slips may occasionally cause a component to burn out, although it rarely affects tubes. In a transistor circuit, the transistor is usually the weakest link and it becomes the victim.

Along these lines, here are some meter precautions which are issued by the manufacturer of the *Regency* pocket-radio receiver:

"Some service ohmmeters utilize circuitry which necessitates an other-than-normal battery polarity inside the meter. With instruments of this type, the red test lead has a negative potential and the black lead has a positive potential. The technician should investigate his meter to determine the polarity of its leads. This can easily be done by connecting a voltmeter across the ohmmeter test prods. When measuring circuits which are critical with regard to polarity (such as those containing electrolytic capacitors), the technician should keep in mind the polarity of the meter leads and should connect them accordingly. The positive lead, whether it is red or black, should be connected to the positive lead of the electrolytic capacitor. The transistors in this receiver would not be ruined if an ohmmeter were to be connected into the circuit in the reversed polarity, but the electrolytic capacitors would give incorrect readings because they would be measured backwards. It is also imperative not to use an ohms range which utilizes a

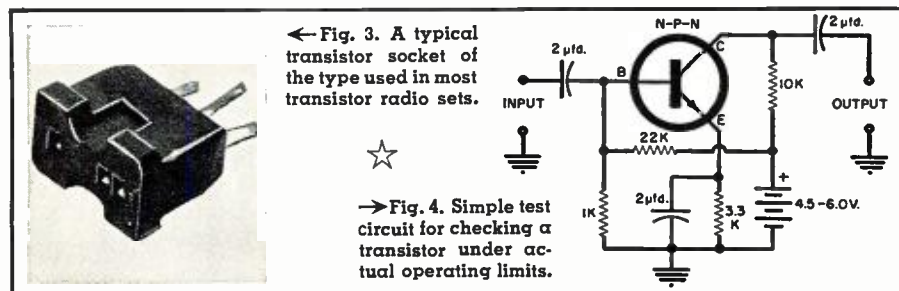

battery of more than three volts, because the transistors can be damaged if too much voltage is applied to them."

Transistors and Parts

In the course of servicing a receiver, the transistor itself may be suspected of being faulty. At the time of this writing there are no really conclusive inexpensive transistor checkers comparable to tube testers on the market. (The *Superior Instrument Co.* Model TV-12 tube checker contains a dynamic transconductance test for transistors using a 5-volt, 60-cycle input signal—similar to that used in vacuum-tube testing.) This leaves the service technician with two alternatives: Either he can substitute another unit known or believed to be good, or he can build his own transistor tester. For the latter, a simple circuit is shown in Fig. 4.

With an a.c. v.t.v.m., measure the signal voltage applied to the input terminals and then the signal voltage appearing across the output. An audio oscillator will serve nicely as the signal source. The gain of the stage is then computed from the ratio of output voltage to input voltage. This value can be compared to the rated value (for a grounded-emitter amplifier) or to that of similar transistors known to be good.

The arrangement shown is for an *n-p-n* transistor. For a *p-n-p* unit, the battery polarity would be reversed.

The tester is simple to operate and will generally provide enough of an indication to enable the technician to judge the operating ability of the transistor under test. Where it might sometimes fall down is in the checking of transistors used in high-frequency circuits, such as the i.f., r.f., or oscillator stages of a radio receiver. It can happen that such units will give a "good" indication at low frequencies, but a "poor" indication at higher frequencies. The only way to uncover such faulty transistors would be to check them at their operating frequencies. If this is not feasible, substitution will be required.

In addition to transistors, there are other components in these miniaturized circuits that may offer the service technician more difficulty than he might ordinarily encounter. This is particularly true of electrolytic capacitors which, because of the low voltages used, have rated working voltages far below those of conventional units. In a transistor radio, a coupling capacitor having a value of 4 μ fd. may be rated at 6 volts or less. If you attempt to check such a unit with a conventional capacitor checker in which the test voltage is generally much higher than 10 volts, you will probably ruin the unit.

Again, one solution to this problem is substitution, although this is generally the more difficult approach, particularly in the printed-wiring circuits common with transistors. Another solution is to use the ohmmeter scale of a v.t.v.m. (Note that the strength of the test voltage should be carefully

checked to make certain it does not exceed the capacitor rating.) If an electrolytic capacitor is suspected of being faulty, disconnect one lead from the circuit and make a resistance check of the unit. Since these units possess a relatively high capacitance value, it is recommended that they be checked on the $R \times 10,000$ range. When the meter leads are connected across the capacitor (with proper polarity observation), the meter needle will deflect across the scale and then gradually return to its infinite resistance position. The smaller the capacitor value, the quicker the needle will return to its original position. An open capacitor will not give any meter deflection at all. A leaky capacitor will have a resistance value, and the meter needle will not return to full scale.

The same method can also be employed to check paper, mica, and ceramic capacitors. Each of these will show a slight deflection on a high-resistance range ($R \times 1$ megohm) and the reading will return quickly to full scale. The smaller the capacitance value of the unit, the smaller the needle deflection. Therefore, this test becomes inconclusive when the capacitance becomes too small. (Offsetting this apparent limitation is the fact that small mica, paper and ceramic capacitors generally have voltage ratings high enough to permit checking on a regular capacitor checker.)

Of the other components in a transistor receiver, inductors and resistors generally offer no test problems since they can be checked in the usual manner by v.o.m.'s or v.t.v.m.'s.

Servicing

Transistor servicing does not differ appreciably from the servicing of vacuum-tube operated receivers. There are, however, certain differences of initial approach due to the use of batteries and transistors and it is these differences (rather than the more familiar similarities) which will be considered here.

For example, when the output of a transistor receiver is distorted, or weak, or completely dead, the prime suspect is the battery. The measurement is made with a v.t.v.m. or high resistance v.o.m. and is best taken with the battery in the receiver and

the latter turned on. If the voltage reading is at or near the correct value, the battery can be presumed to be good. If the voltage reading is off by 20 per-cent or more, then the receiver output may be weak or distorted, but it should not be dead. Since transistor characteristics are linear to very low voltages and currents, chances are that distortion will not occur until the battery voltage drops more than 20 per-cent. There is, however, no set rule regarding this and it is best to try a new battery when the voltage of the existing battery has decreased by this amount. If the distortion or weakness still persists, then some other defect is indicated.

Whenever a weak battery is found, it may be advisable to check the resistance of the circuit across the battery clips before a new unit is inserted. For example, in the *Regency* Model TR-1 receiver, the manufacturer indicates that the resistance between the battery clips (with the battery removed and the receiver turned on) should be between 6000 and 15,000 ohms, as read by an ohmmeter with an internal battery of not more than 3 volts. A reading lower than 6000 ohms will usually indicate a defective component somewhere in the receiver.

Some manufacturers indicate what the current drain on the battery should be instead of quoting the circuit resistance across the battery clips. In this case, a milliammeter must be inserted in series with the battery. For example, with the negative terminal of the battery touching the negative clip, a wire is connected from the negative terminal of the milliammeter to the positive holding clip. Then, one end of another wire is connected to the positive terminal of the milliammeter while the other end of this wire is touched to the positive end of the battery. The value of current indicated on the meter should fall in the range specified by the manufacturer.

If the battery proves to be good, the rest of the troubleshooting procedure follows established practice.

In summary, then, proceed with caution when dealing with transistors until you have learned their idiosyncrasies by heart. After this, you will find them no more difficult to deal with than vacuum tubes.

-30-

Fig. 5. The use of a coil is shown here to feed an r.f. signal into a transistor radio. This method prevents too much signal from entering set and possibly damaging the transistors.

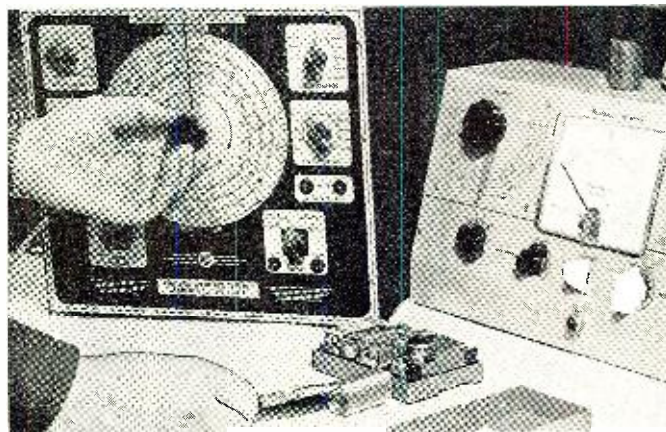

The Art of

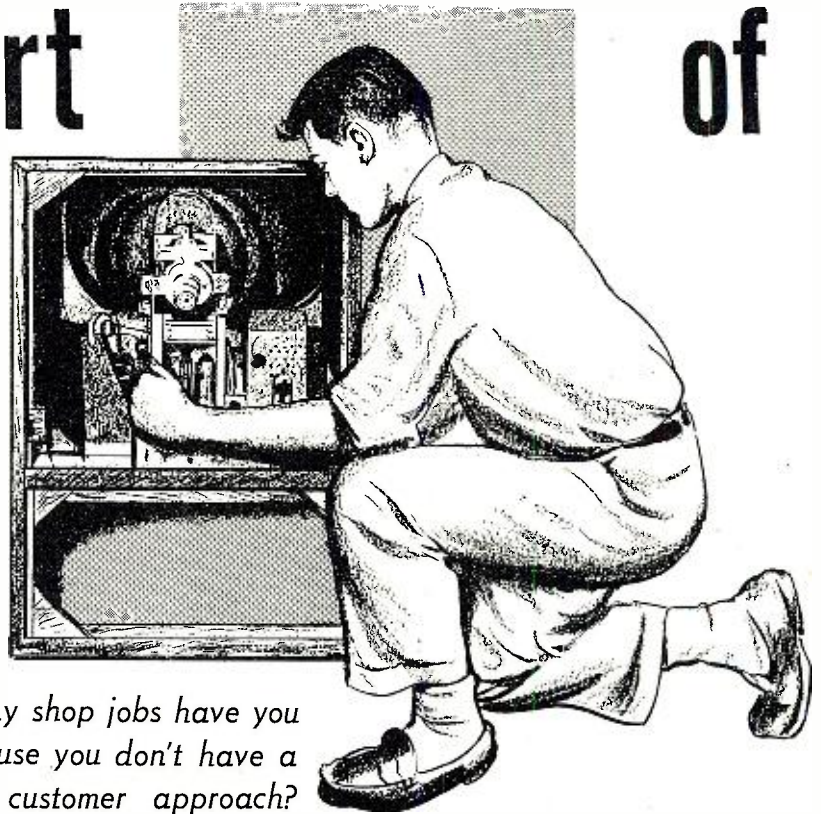

OCCASIONALLY more calls come in than the outside men can comfortably handle and one of our benchmen will take to the street. That was how Mike, our absolutely fastest, most accurate fixer of TV's was assigned three calls in the neighborhood. The first two were tubes and were dispatched by him in short fashion. The third stop was a 16" *Admiral*.

Mike is fast because he doesn't waste any time. He turned the *Admiral* on and noted that the volume control was very scratchy and he had to jiggle the tuner in order to keep the program on. Then a translucent black bar moved slowly down through the picture. Instantly he recognized it as 120-cycle hum. In less than a minute all told he matter-of-factly informed her, "I'll have to pull this into the shop, it needs cleaning and filters."

When the woman asked sarcastically how he knew so quickly, he sat on his tube caddy, wrote up a bill, grabbed the service fee, and left.

In the past twelve months how many chassis jobs were you refused? How many thousands of dollars do they represent? How would you like it if all that "moolah" was snuggled in your pocket right now? Do you agree it's worth a good college try to snag some of it for this next year?

What are the main reasons for a costly repair job refusal? According to our company files some customers just can't come up with the money. Other set owners are looking for an excuse to junk their present sets and get new ones. But these types are the exceptions. The majority of bench jobs that are lost are the service operator's fault. You and I have failed to sell ourselves to the customer. No matter what crackerjack service technicians we are, unless we can subtly inform our client of our unlimited know-how and snow-white integrity, we fail.

In order to establish confidence with a set owner our company has worked out an actual ritual, by the numbers, that each technician goes through religiously on every stop. A service technician arrives at a call in a clean uniform and emerges from a well-kept vehicle. When the customer opens the door she is greeted with a big smile and an announcement of who he is. Then, rain or shine, mud or concrete, the technician carefully wipes his feet. Mansion or hovel, he enters the home respectfully.

He asks the customer, "What seems to be the trouble with your television?" He listens patiently to all and any tales of woe. Then he carefully removes knickknacks and lamps from the re-

How many shop jobs have you lost because you don't have a planned customer approach?

ceiver top and with extreme caution moves it away from the wall. He actually notes what type bolt is holding on the back; slot screw, *Phillips* head, or ¼-inch hex, and with nary a fumble picks the appropriate driver from his colorful tube case. Then he takes the back off with authority. As the customer gazes he takes out a cheater, attaches it, and then goes around to the front. Before reaching for knobs he makes sure which one is the "off-on" switch. Then without hesitation turns that one and only that one.

These things might seem like nonsense and, in regard to the actual repair, they are. But these are the only things the customer can watch and fully understand. You can fumble during the repair, the set owner will never know, but it's fatal to fumble during your approach. If these steps are carried out in a swift, smooth, confident manner you have laid the basic groundwork for customer confidence. The silent salesmanship creates a terrific first impression.

If, on the other hand, a technician grouchily pushes his way into a home, happens to track some mud across a rug, brushes off the customer's natural inclination to contribute to the repair, shoves the set away from the wall with knickknacks shivering, fumbles in the simple operation of taking off the back, and has to be told by the set owner which is the "off-on" switch—well!

Why It Has to Be Pulled

When a technician is working on a receiver in the home he either fixes it or decides the job is of the nature that is best handled on the bench. With some cash at stake the set owner is very

seriously interested in how he came to that decision. Why can't the repair be consummated in the home?

The frank answer would be, "I'm stuck." But saying something like that would be committing monetary suicide.

I was out on a 17" *Stewart-Warner* three-way job. The trouble was obvious. Every now and then the sound and brightness would just leave. There was a monstrous switch that threw the set from TV to Phono to AM to FM while at the same time it killed certain heaters, pilot lamps, and so forth. The contacts on the switch had lost their resiliency. Sometimes it worked, sometimes it didn't. I broke the sad news, "Shop job."

The customer wanted to know why it couldn't be done in the house. I pulled the chassis out, turned it over, and pointed out the tremendous decked switch, its cramped position, its twenty-nine connections, and the possibility of a mistake in wiring unless this repair was made under controlled conditions. Even to the layman it was obvious it was going to be one tedious and pains-taking job. I got the chassis. It turned out to be even worse than I had described.

Ken is one of our street men. His pleasant, easy-going personality has many customers asking for him. He was given a call to repair a 19" *Admiral*. It was one of those real old side-mount "babies." The symptoms were a mess. Lying somewhere beneath a thick layer of dust were the reasons for a weave, insufficient width, intermittent loss of horizontal frequency, and intermittent loss of high voltage. He checked around with a few tubes but the reactions were confusing. Each new 6SN7 horizontal

Pulling a Chassis

By ART MARGOLIS

oscillator required a new setting of the frequency screw. The intermittent loss of high voltage only happened once but it came back too soon for him to locate any bad part. He decided it would be best on the bench. But the set owner wanted to know why since it had never been out before.

Ken sold the job by means of the intermittent. He explained that the intermittent condition could be caused by any one of about six parts. Since it wouldn't act up continually, the parts would have to be changed one by one, until the faulty component had been located. Then, the set would have to be checked until he was absolutely positive the repair had been made. Ken was given the job and he carted the chassis away.

On the bench the repair turned out to be fairly simple for the high voltage went off and stayed off. A .05 μ fd. capacitor (see Fig. 1), in the cathode of the 6W4 damper, acting as a filter for the boost "B+", was leaking badly. The leakage was causing a variance in boost "B+." Odd actions were going on in all the circuits the voltage was feeding. It shrunk the picture, shifted the horizontal oscillator frequency, and caused the miserable weaving.

Our company has definitely increased sales and dispelled a lot of questions and doubts in our customers' minds through the technician's ability to give an easily understood description of what work is going to be done.

How Long Will It Take?

The second question a TV set owner will ask is, "How long will I be without my television?" The briefest answer you can give is, "I don't know." We don't say that. Our boys are armed with the statistical fact that our shop jobs from pickup to delivery run between two and three days. Some "dogs", of course, can take much longer but we have provisions for that.

I was out on a call. The receiver was a 16" *Mirrortone*. The TV was entertainment for a mother and her brood of seven boys and three girls, the eldest being fifteen. The symptoms were the worst that could happen on that particular set, complete loss of channels 7 to 13.

It had one of these, "once a brain-storm now a headache," one-tube tuners employing a 12AT7 for r.f. amplifier, mixer, and oscillator. The symptoms had become classic. From many of its predecessors, I knew the high-band grid oscillator coil in the tuner was open. The only trouble was that it would cost more in labor to fix this tuner than it was worth. Also, this

little one-tube job was obsolete. We were going to have to use a substitute tuner. The repair was going to be a mess physically and electrically.

The customer agreed to a new tuner but asked anxiously, "How long will it take?" I gave her our stock answer. "The average job takes two to three days." Then I added, "However this repair will probably take a little longer. I can call you as the work progresses."

It wasn't until the third day that we located a suitable tuner. During the fourth day the chassis was hacksawed and some additional holes punched. The fifth day saw the installation. During the sixth the power supply was jazzed up to provide additional current for the two tubes replacing the original one. Exactly a week later the *Mirrortone* was delivered. The customer was well satisfied with the repair for I had called her every night and told her how things were going.

Jack, another of our service technicians, was doing a house call for a shut-in on his 14" *Emerson*. Intermittently the video would fade, retrace lines appear, and the brightness bloom slightly. He checked all the high-voltage and power-supply tubes but it didn't help. He told the customer the set would have to go to the shop. The sickly man asked how long it would take. The stock answer was, "Our average job takes about two or three days, if it takes any longer I'll keep you posted on progress." With that commitment he received the go ahead.

On the bench the trouble was isolated on the second day. Surprisingly enough, it was a heater-to-cathode short in the picture tube. Pin 1 was grounded and every time it shorted, the video was shunted off. See Fig. 2. The brightness control still worked, confusing the issue, because it was stationed on the control grid. The CRT was in excellent shape otherwise, so the benchman used a reactivator. It worked like a charm. The set was delivered to the anxious client at the end of the second day.

How Much Will It Cost?

The third customer query and the most critical one is "How much is it going to cost?" Again the shortest answer would be, "I don't know." That shortest answer is the best way to cut your own throat. Also, it is not true. When you pull a chassis, from past experience you have a good idea what it is going to cost. You also have a definite method of charging for shop jobs.

Jack went on a service call involving a 21" *Motorola*. When he first turned on the receiver he got good sound but

no brightness. Then after about three minutes a faint glow appeared and turned into a dull picture with insufficient width. He checked tubes to no avail. It was going to have to go to the shop. The customer naturally wanted to know, "How much?" Jack thought it over and figured the worst it could be was a high-voltage transformer job. However, there was a good possibility of it being ten to fifteen dollars less. With these commitments he was given the repair.

The set was fixed in less than an hour. Coming off the phase detector plate and going to the high-voltage transformer were a pair of 150,000 ohm resistors that had changed to about 4000 ohms each. They were attenuating the horizontal output pulse generated in the transformer. With a bill less than the worst, the customer was thrilled and we enjoyed a profitable bench job.

With most people a general discussion of prices is all that is necessary but occasionally there is always the hard character. Hank was out in the rougher section of town. He walked in on a 17" *Hallcrafters* and its burly owner. The symptoms were strange. There were sound bars in the picture, and if he turned the volume control down the bars disappeared completely. If he turned the volume control up the bars would get so violent they broke the picture up into little jagged horizontal pieces.

He began checking tubes. As he worked the customer kept up a nasty patter of disparaging remarks about how he was taken by TV service operators in the past. Finally, Hank came to a conclusion. He told the unpleasant customer it was a shop job. The set owner almost hit the ceiling. Then he said, "Yeh, well how much is it going to cost?"

(Continued on page 118)

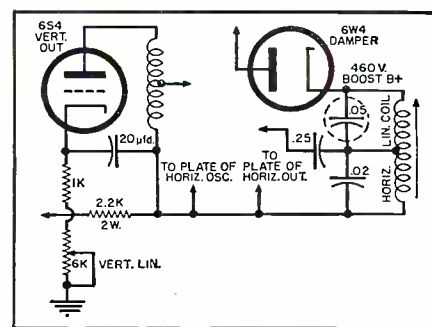
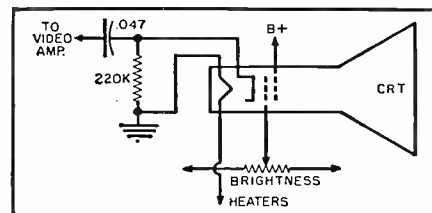

Fig. 1. A leaky .05 μ fd. capacitor in the damper cathode circuit affected the boost "B+" causing intermittent troubles.

Fig. 2. A heater-to-cathode short in this picture tube produced a loss of video as well as a case of blooming.



1956

EMERSON Test Points

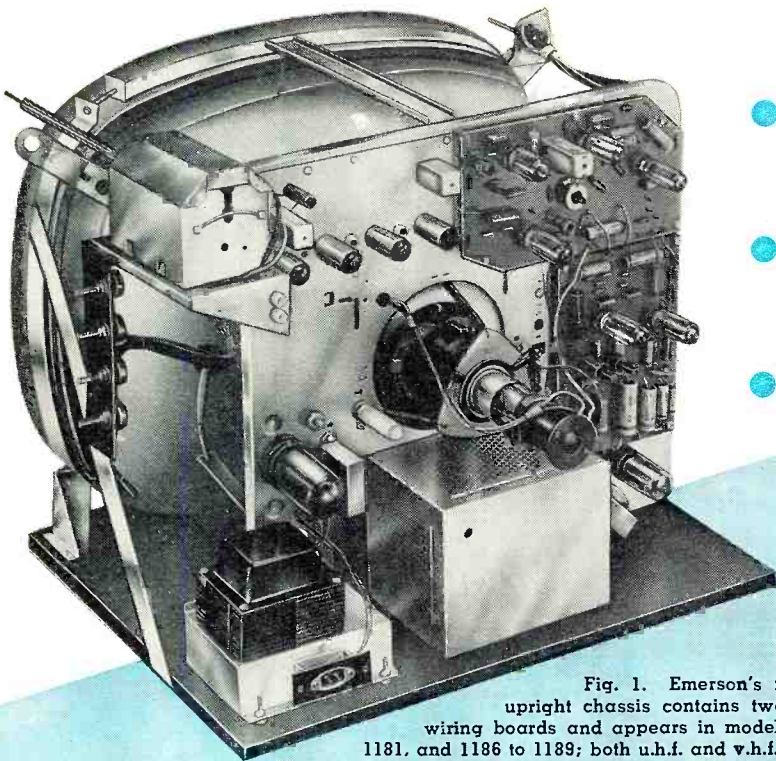

Fig. 1. Emerson's new 1956 upright chassis contains two printed-wiring boards and appears in models 1176 to 1181, and 1186 to 1189; both u.h.f. and v.h.f. versions.

By **HAROLD BERNSTEIN**
Service Manager
Emerson Radio & Phonograph Corp.

Here's another of the monthly articles describing test points which can be used for rapid checking in the home.

EMERSON'S new 21" and 24" upright chassis contain two printed-wiring circuit boards as shown in Figs. 1 and 2. These boards house the inter-carrier sound circuits, the sync and sweep oscillator circuits, and also the video output circuit. The tuner, video i.f., sweep output, power supply, and high-voltage sections are wired directly to the chassis in the conventional manner.

A novel power transformer effectively places each side of the power line at about 55 volts a.c. above chassis potential. Because of this, two relatively short series heater strings are used rather than one long one. This has the advantage of allowing use of the ruggedized 600-milliamperre heater tubes without having to check 16 or more tubes in the event one tube opens up. With the use of this circuit it is only necessary to check 8 tubes, since the other 8 tubes in the alternate string will remain lighted.

These chassis use 18 tubes (19 plus a 1N82A crystal on u.h.f.-v.h.f. chassis). The 5U4GB rectifier obtains its filament power from a separate winding on the power transformer while the 1B3GT high voltage rectifier obtains its filament power from a tap on the horizontal output transformer.

Some special features of these chassis are the use of an "all area" cascade tuner which will operate efficient-

Fig. 2. The various test points on the two printed-wiring boards are shown here. The information available at each test point and how to use it is described in Table 1.

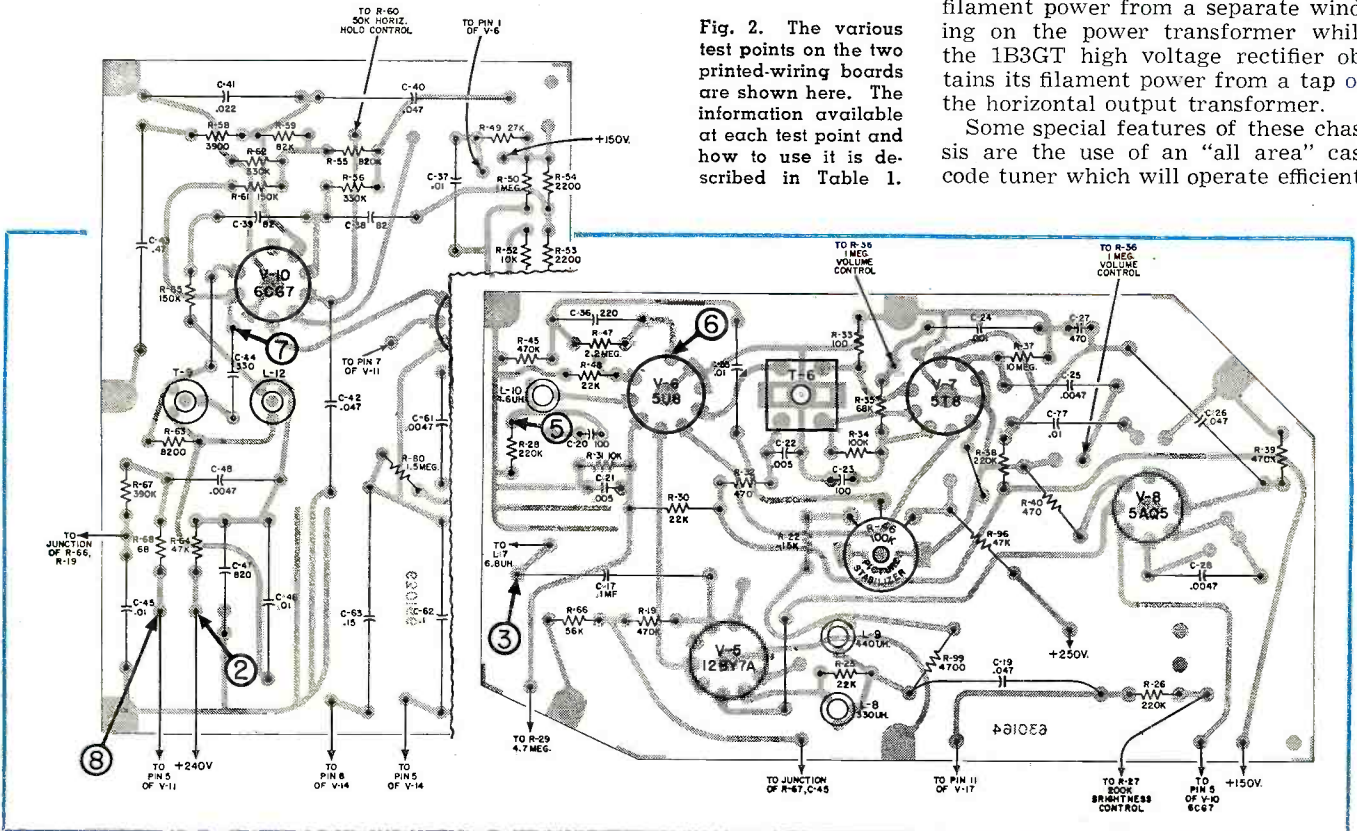

ly over a much wider range of input signal strength than the previous tuners used. This is especially helpful in locations which receive both very strong and fringe signals. In this tuner, a.g.c. is not only applied to the cascade r.f. tube but, indirectly, it is also applied to the converter tube. A "local-distant" a.g.c. potentiometer control is also provided to optimize performance in a particular location.

Noise inversion is also a feature of these chassis. The amount of noise inversion is controlled by the setting of the "picture stabilizer" control and will provide optimum sync performance in areas of weak signal and high electrical noise interference.

The upright construction of these chassis and the use of two printed wiring boards eliminates the need for special test points. When the back of the set is removed, all receiving tubes are within easy reach for replacement purposes. Components used with the printed-wiring boards are mounted so they will be accessible when the back of the set is removed. These components can be replaced if necessary without removing the chassis from the cabinet simply by clipping the pigtails close to the defective component and soldering a new component directly to these pigtails. This makes servicing simpler, faster, and more economical.

In the event the heater of one tube should open up, picture, sound, and raster will be lost, irrespective of the series string involved. It should be pointed out, however, that heater failure is seldom the reason for a defective tube. Usually, excessive gas, shorted elements, or low emission is the cause and, therefore, the set can

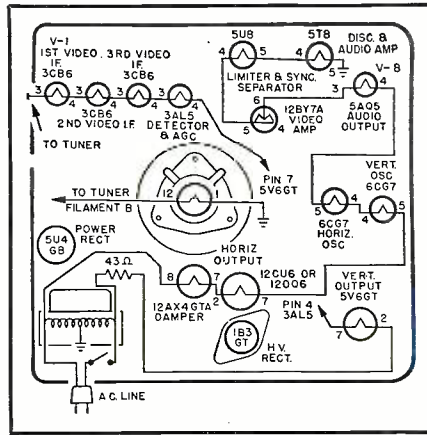

Fig. 3. Tube location diagram for the Emerson upright chassis. Note how the tube heaters are connected together.

be serviced in the conventional manner.

To locate an open heater without removing the chassis from the cabinet, use an ohmmeter or continuity checker. The ohmmeter should be set to a low scale and no more than a 3-volt battery should be used in the continuity checker. This is important especially when checking for continuity across a 3-volt tube such as the 3CB6. (A simple inexpensive continuity checker can be made with a 3-volt battery in series with a #40 pilot light bulb.) Refer to the tube location diagram, Fig. 3, and remove the tube which is connected in the middle of the string of 8 tubes which are not lighted (V_6 or V_8). With an ohmmeter or continuity checker measure across the heater pins of this tube. If continuity is present, leave the tube out

of the socket and check from one heater point of this tube socket to the chassis. If OK, check from the other heater point of this tube socket to chassis. This will quickly isolate the trouble to one of three or four tubes. From this point on, finding the tube with the open heater will be simple. Note: when looking at the top of a tube socket be sure to count pin numbers in a counterclockwise direction from the keyway or wide pin spacing reference point. Since the chassis is approximately 55 volts a.c. above ground, use an isolation transformer.

The various test points for checking receiver operation are shown in Figs. 2 and 3. The method for using these test points is described in Table 1. Aside from the main source of "B+" voltage at the power supply, each of the test points draws current. In Table 1, it is assumed that all heaters are lighted and that tube changes have already been tried. This table covers some of the high points but is not intended to cover every service need. For tough service jobs the use of service notes and an oscilloscope will prove helpful.

Note that all parts appearing in solid black lines on Fig. 2 face the technician as he opens the back of the receiver. The printed wiring is on the other side of the board and seldom needs checking. Be certain to use a low power soldering iron when soldering components into the circuit and do not apply heat directly to the printed wiring.

The picture tube of these receivers is mounted directly to the chassis so that it will come out of the cabinet when the chassis is removed. -30-

Table 1. Procedure for rapidly servicing the 1956 Emerson upright chassis TV receivers via the use of test points.

SYMPTOMS	TEST POINT	NORMAL READING	TEST PROCEDURE
Weak or no picture, no sound.	"1" (tuner converter)	-1 v. to -5 v.	Grid conduction of mixer due to oscillator voltage develops this voltage which varies from channel to channel. Check other channels, if OK, change oscillator strip of affected channel; if not, check "B+" voltage to tuner. Should be 150 and 240 v. If much lower, disconnect "B+" inputs to tuner and measure "B+" again. If OK, there is short in tuner. If still low, check power supply.
No sound, no raster.	"2"	240 v.	Check fuse. If fuse keeps popping, check "B+" points for shorts. Disconnect electrolytic filter capacitors and reconnect one at a time.
Small raster, weak picture, & low brightness.	"2"	240 v.	Resistance from 240-volt point to chassis should be about 40,000 ohms. If much lower, find feedline with short by removing one at a time. If short occurs only when set is on, disconnect all feedlines and reconnect one at a time. Feedline which materially reduces voltage at this point most likely contains short.
Weak or no picture, no sound, & raster OK.	"3" i.f. a.g.c.	-1 v. to -6 v. (depends on signal strength)	If a.g.c. is over 10 volts negative, i.f. stage is probably oscillating. If a.g.c. measures high on weak signal, an i.f. stage may be regenerative. Check dress of components near detector, alignment of i.f. stages, and screen bypass capacitors.
Picture bent, buzz in audio, video overload, or weak picture and sound in strong signal area.	"4" tuner a.g.c. (white lead to top of tuner chassis)	-3 v. to -3 v. (set "local-distant" control full clockwise.)	For severe picture overload, check components in a.g.c. circuit. If picture and sound are weak where they should be strong, then signal is not getting through tuner or i.f. circuits. Voltage and resistance readings on tuner and i.f. stages (i.f. coils included) should indicate trouble.
No sound, picture and raster OK.	"5"	-3 v. to -20 v. (depends on signal area)	Good reading means audio is getting to this point. If reading is low on strong channel, trouble is due to misalignment or component failure between video detector and sound limiter. If reading is normal, check discriminator and audio output stages.
Poor or no vert. and horiz. sync, picture and sound OK.	"8"	-45 v. to -10 v.	If reading is OK, trouble may be due to severe video overload (r.f., i.f., or video amplifier), or to defective sync phase inverter circuit. If reading is incorrect, check components between plate of video amplifier and grid of sync separator. Note: make sure "picture stabilizer" and "local-distant" controls are adjusted as indicated on back of set.
Horiz. hold unstable, vert. hold OK.	"7"	-50 v. in sync -55 v. (no signal free running)	If not normal check horiz. osc. and a.f.c. circuit. If normal, check alignment of frequency and phase coils.
No high voltage.	"8"	-17 v.	If OK, trouble is due to circuits between grid of horizontal output tube and deflection yoke. If not normal, check test point "7." If OK, then trouble is in grid, screen, or plate circuits of horizontal output tube.

Service



By **E. EUGENE ECKLUND**
Author, "Repairing Record Changers"

Record Changers

Almost every TV home you enter as a service technician has a record changer that needs repair or adjustment.

RECORD changer service is a source of income too frequently ignored. In many types of businesses, loss-leaders and other merchandising schemes are used to attract the customer in the expectation of getting other business. Getting to the customer is obviously of value.

In the service business you cannot afford to give anything away. However, the next time you are in a customer's house to fix his television set or radio receiver, use your position to advantage and suggest that the record changer be checked. The results you get may surprise you. Just the needle business from hi-fi units will substantially increase your income.

To take full advantage of the record-changer business that you get, you must be prepared. This requires that a few special items be included in your toolbox. These include a pair of duck-bill pliers, a small level, a small mirror (either pocketbook size or dental type), a small screwdriver 2" long with a $\frac{1}{16}$ " blade, a set of open-end wrenches ranging from about $\frac{7}{32}$ " to $\frac{1}{2}$ ", crocus cloth, a pocket microscope, and several small files.

Many troubles are traceable to the needle or cartridge. First, a detailed check of the needle is advisable. Use a pocket microscope of about ten times magnification to inspect the tip. One of the commonest problems is use of the needle much beyond normal life. This causes excess wear and gouging of the record grooves. If the needle is worn, show it to the customer and explain the effect on the records. Most people have more money invested in records than in the record player. The relatively low cost of a needle is a

small premium to pay to protect these records.

In addition to defective needles, a defective cartridge affects tone or volume. This can be checked by playing a record. To eliminate confusion, you might carry a record with you. Use one that has both soft and loud passages and a variety of instruments. Even if you do not have a musical ear, you can quickly spot distortion, hum, poor volume, and other related problems. Since time is money, get a record that gives you a check in as short a time as possible. If you make this check after inspecting the needle, your test record will not be damaged.

If you get a distorted tone, inspect the needle first. Then check to make sure that the needle is centered between the guards or the pole pieces, as shown in Fig. 1. Clean out any lint or dirt, too. Should the distortion remain, see if the pickup arm binds or has been damaged. If the pickup arm is all right, replace the cartridge. Do not confuse rumble, thumping, or other mechanical noises with distortion. If such defects jar the record, the needle will pick them up and they will be amplified.

Hum is caused by a.c. power-line pickup. Reversing the plug in the convenience outlet may help. If not, determine whether the trouble is in the amplifier or the record changer. To do this, remove the connector to the amplifier. Listen for hum. If hum is not present, the trouble is in the record changer. If hum is heard, short the amplifier input connector. The hum will disappear if the amplifier is satisfactory. Normal radio troubleshooting techniques will locate any amplifier

trouble. If the record changer is at fault, look for an open lead or a poor connection of the pickup-wire shield at the cartridge, changer base, or amplifier connector.

The cause of poor volume can be isolated by checking with your finger. Rub the needle lightly with your index finger, and set the volume so the scratch is heard clearly. Now touch the signal lead at the cartridge terminal. If a loud hum is heard, the cartridge is probably at fault. If the hum is no louder than the previous scratch, either the signal lead or the amplifier is at fault. To determine which one it is, disconnect the lead at the amplifier and touch the amplifier input connection with your finger. If the volume is the same, the amplifier is at fault. A loud hum indicates a defective lead.

Next check needle pressure and friction. For this you will need a gauge. Pressure is an indication of the balance of the pickup arm. It is measured by placing the needle on the gauge, and reading the average of the pointer position as it is moved slowly up and down. Microgroove needles exert a pressure in the range of 5 to 7 grams. For 78-rpm records it will be between $\frac{3}{4}$ and $1\frac{1}{4}$ ounces. If it is considerably above this, it is likely that the record changer is rather old and the reading is normal. Here is a good opportunity to sell a new record changer on the basis of the smaller needle pressure. Explain that since the needle area is small the pressure is tremendous, and modern equipment is much easier on the record.

Vertical friction is checked by moving the gauge up and down and reading the *difference* between the extremes of needle pressure. Horizontal friction is similarly measured. First balance the pickup arm by hanging a weight at the rear, then move the needle back and forth laterally and read the difference.

Vertical friction should be less than

one gram. Horizontal friction should be less than 3 grams. Vertical friction is determined by the pivot and counterbalance system, the horizontal friction is affected by the pickup-arm shaft mounting. If the friction is excessive, these points should be respectively cleaned and checked.

The reaction you get by measuring friction and pressure will probably be surprising. This simple measurement with an inexpensive gauge is not often seen. If you use it as a part of your routine, you will probably make a very good impression as an exacting service technician.

Now check the turntable speed by running the turntable with a stroboscope disc placed on it. If the speed is exactly right, the dots or bars will stand still when illuminated with an a.c. light. A fluorescent light is best. If the speed is too fast, the bars or dots will appear to move clockwise. If the speed is too slow, they will appear to move counterclockwise. The allowable speed tolerance is about three per-cent (about 216 bars or dots per minute or about 3½ per second) moving past a fixed reference point. Often the customer's ear will not allow such wide variations, so you will have to be guided by his reaction and complaints. Tolerances in professional turntables are about 0.3 per-cent maximum (21 bars or dots per minute maximum above and below proper speed).

When checking speed, take readings with one record on the turntable and again with a full stack of records. It is likely that loading will affect the speed somewhat. In this case it is best that the speed be slightly fast with one record, and slightly slow with a full stack. Also look to see if the turntable rotates at constant speed. Variations in speed are called flutter or wow and will show up as cyclic changes in the rotation of the bars or dots on the stroboscopic card. Test records of single-frequency notes are also available for this purpose. These variations in speed create a varying change in pitch as the record plays. Flutter is usually a relatively high-speed variation due to a defect in the motor; wow is low speed and originates in the idler wheel or coupling system.

The possible causes of speed varia-

tions and inaccuracies are shown in Fig. 2.

This completes a check on the playing of records. If these tests check properly, there will be no problem. To complete the job it is necessary to check the changer mechanism.

Changer Mechanism

Place a record on the supporting shelves, adjust the record changer to automatic, and start the unit by turning the control knob to *reject*. Watch to see that the record drops properly without hanging up on the record supports. Then make sure that the needle sets down at the outer edge of the record midway between the edge and the first playing groove of the record.

Play the record through and check to see that after completion of the playing grooves the record changer trips and drops the next record to the turntable. If the record changer has an automatic shutoff feature, check to see if it works properly after playing the top record in the stack.

The key parts of one type of record changer are shown in Fig. 4. Power for all portions of the changer mechanism is obtained from the motor, being transmitted through the idler wheel, turntable, and hub gear. When the change cycle is started, the clutch pawl engages in such a way that the hub gear is made to rotate the trip, drop, and indexing mechanisms.

If the record does not drop properly, check to see why not. The record pusher (which moves the record off the shelf support) is located in either the spindle or one of the record shelves. It is controlled from beneath the baseplate. Place a record in position and see if the record pusher lines up properly with the record. Then cycle the record changer and observe the record drop. If it operates properly, the record is probably at fault.

If the record pusher does not operate, you want to find out why. Turn off the power. Place another record on the shelf, and hold the control knob in the *reject* position. Observe the changer mechanism under the base while you rotate the turntable clockwise by hand. To determine the mech-

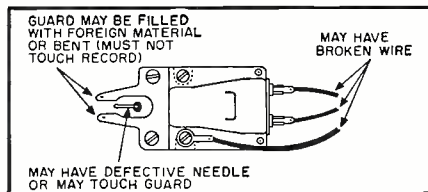

Fig. 1. Distortion and hum may originate in the pickup. Shown on the typical pickup here are some possible causes.

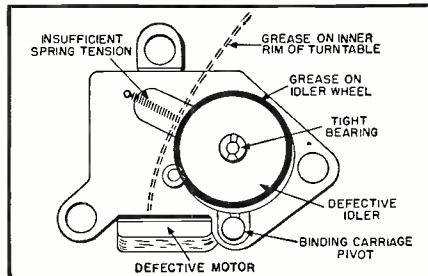

Fig. 2. Flutter and wow are distortions in reproduced sound caused by speed variations of the turntable which, in turn, may be due to the reasons shown here.

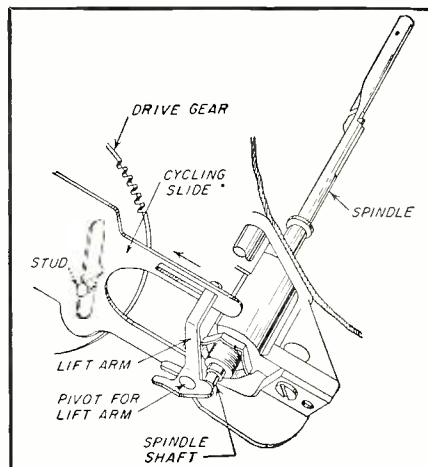

Fig. 3. Most of the operating parts of a spindle-type record drop mechanism.

anism involved, look for the link between the drive gear and the record pusher. In the pusher-type drop mechanism of Fig. 5, the record is pushed off the spindle by the inward movement of the record-selector post. The link consists of the cycling cam and

(Continued on page 137)

Fig. 4. The key operating parts of one type of record changer.

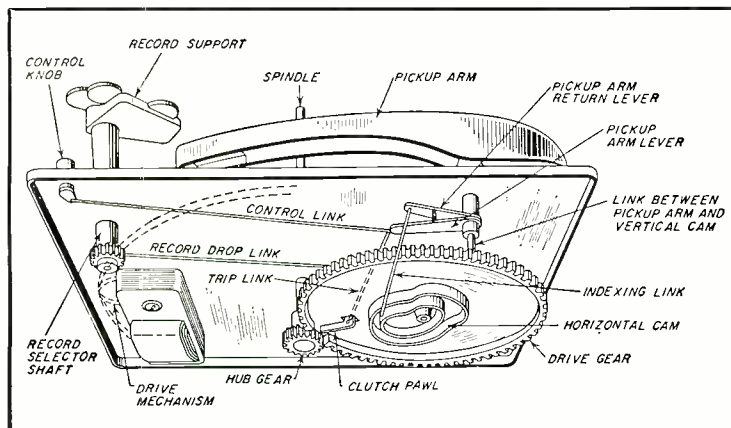
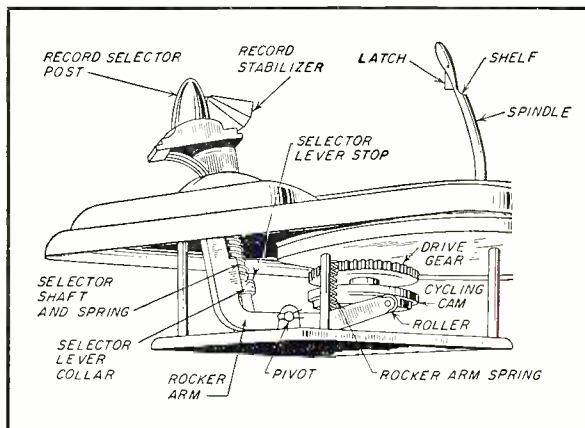

Fig. 5. A popular pusher-platform record drop.



Certified RECORD REVUE

By **BERT WHYTE**

IN MY report on the New York Audio Fair several months ago, I told you I would give you the lowdown on the revolutionary disc pressing process which created such a furor at the show, as soon as I could. Well, the time is now—so here goes! This new process is the brainchild of canny Jim Miller, the same gentleman who invented the fabulous *Miller* disc cutter. Essentially, the process is this . . . a "pre-formed biscuit" of particles of almost 100% pure vinylite, is placed on top of one half of the master stamper which is supported in a heavy steel bed. This bed is, in turn, the lower half of the complete press which, believe it or not, is not much bigger than a couple of cases of beer! In the top half of the press is the other half of the master stamper. The top unit is lowered so that it meets the other half and then, simultaneously, pressure is applied along with high-frequency radio waves which heat the biscuit" by induction. In the case of both pressure and heat, far less is applied than in the normal steam pressing method. The time cycle involved is also appreciably less. On opening the press, you find that the vinyl particles have fused together and the stampers have made perfect impressions. What's the big deal about all this? Well, consider the size involved . . . a steam press is gigantic when compared to this unit. Consider that with no plumbing and so little stray heat, etc., this unit can actually be run on a kitchen table! Because of the relatively low heat, many of the fillers that are normally used in many brands of records, like certain waxes and lubricants are not necessary.

The almost perfectly pure vinyl with this process gives records singularly free from many of the defects that are cause for rejection, in addition to surfaces which are *utterly dead quiet!* The units are being manufactured by *Components Corp.*, well-known turntable builders and from what I've been able to gather, there are a number of record companies eagerly awaiting the machine's release.

A pioneer in the field is Emory Cook, whose *Cook Records* are being manufactured by this process under the name "Microfusion." Reports so far have indicated much public enthusiasm. The implications of this *Miller* process are very far reaching. Consider the unhappy disc company with millions of dollars of capital invested in huge steam pressing plants. If a large public demand is created for these quieter pressings, what happens to these plants?

On the other side of the fence, however, are some very tangible benefits for the record companies. Take the case of the typical "Hit Parade pop record" . . . the money-making life of these discs is a very transient thing. One of the problems confronting a record company is that when they have a "hit" on their hands they have terrific distribution

problems, especially if the plant happens to be on the East Coast and the big demand happens to be on the West Coast. To satisfy the demand which is a most uncertain thing and difficult to predict, the record companies are forced to ship their distributors discs by the thousands. If the "hit" is a really big one, these may be all used up and further shipments are then necessary. On the other hand, the "hit" may fizzle out like a Roman candle in a few weeks and the distributors find themselves loaded with an excess of the discs. These the record company takes back and about all they can do with them is throw them in the scrap bin. With the *Miller* process all this could be alleviated.

Picture, if you can, each record company distributor in a key city equipped with one or more of these fusion units. When the record company has a "hit," they fly master stampers to their distributors, and then the distributor becomes a custom pressing plant and turns out the number of discs needed as required by local demand. Most of the waste is eliminated and they can offer fantastic service to the retailer. Just supposin' that two months after a certain hit is presumed dead and buried . . . and some character walks into the store and wants a copy of same . . . nothing to it. You call the distributor who gets the master stamper from his file, slips a "biscuit" into his machine and *Voila!* . . . we have the disc and everybody's happy! There are many other advantages to this machine and I have no doubt that although there will be plenty of opposition, it won't be too long before it will find wide use.

Equipment used this month: Pickering arm and "Fluxvalve" cartridge, Components Corp. turntable, Marantz audio console, McIntosh 60-watt amplifier, Jensen "Imperial," and Electro-Voice "Georgian" speakers. Tape Equipment: Ampex 600 and 612 units.

LALO NAMOUNA (BALLET SUITES #1 AND #2)

London Philharmonic Orchestra conducted by Jean Martinon. London LL1268. RIAA curve. Price \$3.98.

To those of you who have wondered if Edouard Lalo ever wrote anything besides the "Symphonie Espagnole" . . . here is your answer . . . a most interesting rather spritely ballet with the somewhat implausible name "Namouna." No, Lalo didn't have an affair with some South Seas beauty of that name, rather that is the name of the heroine in the somewhat overblown story of the ballet. In two suites, the first is the more exciting from a strictly sonic viewpoint and the second has more intrinsic musical worth as well as its

The opinions expressed in this column are those of the reviewer and do not necessarily reflect the views or opinions of the editors or the publishers of this magazine.

share of hi-fi pyrotechnics. The scoring is an odd admixture of traditional 19th century ballet, with more than an occasional backward look at Berlioz and with astonishing modernism in evidence now and then, for example, a discordant tuba figure in the "Prelude" to Suite # 1.

This is really a beautifully conceived and altogether melodious work which should find favor among balletomanes with jaded appetites.

Orchestral work of the London Philharmonic is of very high order with splendid ensemble work in the strings, exceptional woodwind playing, and some highly accurate percussion work. Martinon is right at home with the French repertoire and although no score is available or other records for comparison, evidence of his good conducting is noted in the fine balance he maintains in the various choirs, and the steadiness of his beat. Soundwise this is another exemplary job of engineering from *London*. The strings are very clean and edgeless, woodwinds are "live" and "breathy," punchy brass (listen to the final section of the second suite for an example of brass realism coupled with a fine bass counterpoint). Throughout both suites there is much percussion to gladden the hi-fi heart, with both high percussives such as cymbals, snares, castanets, etc., and a whopping bass drum which is much in evidence. Frequency and dynamic range are quite wide, groove distortion was not noted, and the score was clothed in spacious acoustics. An off-beat item that most people will find quite enjoyable.

MOZART THE MARRIAGE OF FIGARO (COMPLETE)

Cesare Siepi, Hilde Gueden, Lisa Della Casa, Suzanne Danco, other soloists with Vienna State Opera Chorus and Vienna Philharmonic Orchestra conducted by Erich Kleiber. London XLLA-35. RIAA curve. Price \$19.92, Four discs.

With the Mozart Bicentennial has come a great outpouring of records devoted to his music from virtually all the record companies. Such is the mad profusion of them that were 1956 to end with the complete works of Mozart on LP, I don't think it would amaze very many people. *London* has so far mustered the heaviest artillery with complete new versions of "Don Giovanni," "The Magic Flute," and this present recording. And what stellar productions! All are packaged in new duplex containers, one side being for the record album and the other for a complete score with German-English or Italian-English libretto as the case may be. Certainly this is a boon to the more musically erudite of our readers.

This "Figaro" is miles ahead of any competing version including the old Busch/Glyndebourne Festival reading. This would be obvious in matters of sound, but is superior also in performance (a circumstance many people thought to be impossible). A more vigorous and robust "Figaro" than Siepi would be hard to imagine, and all the other participants are equally "at home" in their roles. Particularly effective are Lisa Della Casa as the Countess, and Fernando Corena as Dr. Bartolo. One of the major reasons for the success of this production was the inspired conducting of Erich Kleiber. Here is a man who knows and loves the score and respects its intentions. He takes no undue liberties with tempi, nor does he indulge in mannerisms, or in any way try to "symphonize" the work. A smoother, better integrated, wholly lovely performance of this work will be a long time in coming.

Soundwise *London* has its standard flying
(Continued on page 165)

New Picture Tubes for 1956

By
WALTER H. BUCHSBAUM

Television Consultant
RADIO & TELEVISION NEWS

More 90° deflection tubes, single magnet ion traps, and aluminized screens, but screen sizes stay put.

THE past year has seen a number of new picture tubes produced which will be used in the black-and-white receivers currently in production. An RETMA tube type number, 21AXP22, has also been assigned to the 21-inch color tube which RCA and many other manufacturers are using in their color TV receivers. Some later types of color picture tubes have recently been announced having 22-inch face plates and using all glass construction instead of the metal envelope used on the 21AXP22. The basic features of these later versions are, however, the same as the 21AXP22 and include the curved shadow mask, convergence magnet assembly, and an improved purity magnet assembly. The blue beam is adjusted by an external magnet, and the tube requires no ion trap.

All the new black-and-white picture tubes listed in Table 1 have rectangular glass envelopes with the face plate either neutral gray or else of a denser filter glass. The majority of the new tubes use a single-magnet ion trap and there are some that require no external ion trap, pointing to the obsolescence of this particular component.

Deflection angles vary from 70° to 90° with the latter wide-angle deflection slightly in the majority. From the service technician's point of view this means that he will have to stock 90° deflection yokes as replacement parts. Also, TV receivers using the 90° deflection-angle tubes may have a tendency to show more horizontal deflection troubles than the earlier 70° receivers. The wide deflection angle goes together with the almost uniform nominal 16-kilovolt second anode voltage recommended by most manufacturers. This requirement puts a considerable burden on the flyback section and necessitated the development of new components featuring higher input power and greater efficiency. The effects of aging and climatic changes, and other deflection and high-voltage troubles will be more acute with the higher "Q" of the components.

The majority of new picture tubes use low-voltage electrostatic focus, which was introduced successfully two years ago. In general, the focus voltage will be varied from 0 to about 350 volts either by a potentiometer or a fixed voltage divider. Some of the new tubes use magnetic focusing which allows their use as direct replacements for older types.

Each CRT type listed in Table 1 may have one or more versions designated by different suffix letters such as "A," "B," etc. These tubes are identical except for some constructional details such as the application of an aluminized screen, external conductive coating over the entire envelope or only a portion of it, etc. A few words might be added concerning the use of aluminized screens.

CRT	Face Plate	Focus	Defl.	Ion trap
5AXP4	Round clear	none	53°	none
17ATP4	Rect. gray	low volt.	90°	single
17AVP4	Rect. filter	low volt.	90°	single
21ALP4	Rect. filter	low volt.	90°	single
21AMP4	Rect. filter	mag.	90°	single
21ATP4	Rect. filter	low volt.	90°	single
21AUP4	Rect. filter	low volt.	72°	single
21AWP4	Rect. filter	mag.	72°	single
21BAP4	Rect. gray	low volt.	90°	none
21BCP4	Rect. gray	low volt.	70°	none
21BDP4	Rect. gray	low volt.	72°	none
21BNP4	Rect. gray	low volt.	90°	none
21EP4	Rect. filter	mag.	70°	single
21FP4	Rect. filter	low volt.	70°	single
21YP4	Rect. filter	low volt.	70°	single
21ZP4	Rect. filter	mag.	70°	single
21AXP22†	Round metal	high volt.	70°	none
24CP4	Rect. filter	mag.	90°	single
24DP4	Rect. filter	low volt.	90°	single
24YP4	Rect. filter	low volt.	90°	single
24ZP4	Rect. filter	low volt.	90°	none
27RP4	Rect. filter	mag.	90°	single

†Color TV tube.

Table 1. List of the new picture tubes used in current TV models and those on the production lines.

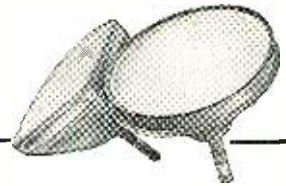

Practically all major tube manufacturers now recommend the use of aluminized-screen tubes under various trade names. The addition of a very thin reflective surface behind the phosphor results in greater light output for a given electrical input. This does not mean that a non-aluminized tube cannot be made to give as bright a picture by applying more beam current. It does mean that the aluminized screen requires less beam current with resulting longer cathode and screen life. On the other hand, the installation of an aluminized-screen tube in an old set will not mask such defects as low anode voltage, poor regulation, poor focus, or weak video signals.

The first tube listed in Table 1 is unusual in that its only purpose is to serve as a test component for the TV service technician. The 5AXP4 is a small, round, glass tube without external coating, ion trap, or focus connection. It makes it possible to check TV receiver chassis without using their own picture tubes and so facilitates servicing in the shop. No elaborate mounting arrangement is necessary and no time need be wasted in connecting deflection yoke, focus coil, and ion trap. The test picture tube is simply inserted into the deflection yoke and plugged into the original tube socket. Then the anode voltage is connected to the tube and it is ready to operate. Considerable tolerance exists in first and second anode as well as grid characteristics, so that the 5AXP4 will produce good pictures with any type chassis. For sets using 90° deflection, the screen may be overswept, but this does not matter since the final width and height adjustments would have to be made with the original tube in the cabinet anyway.

By **OLIVER READ**
 Editor, **RADIO & TELEVISION NEWS**
 and
JAMES RILEY

EVOLUTION of the PHONOGRAPH

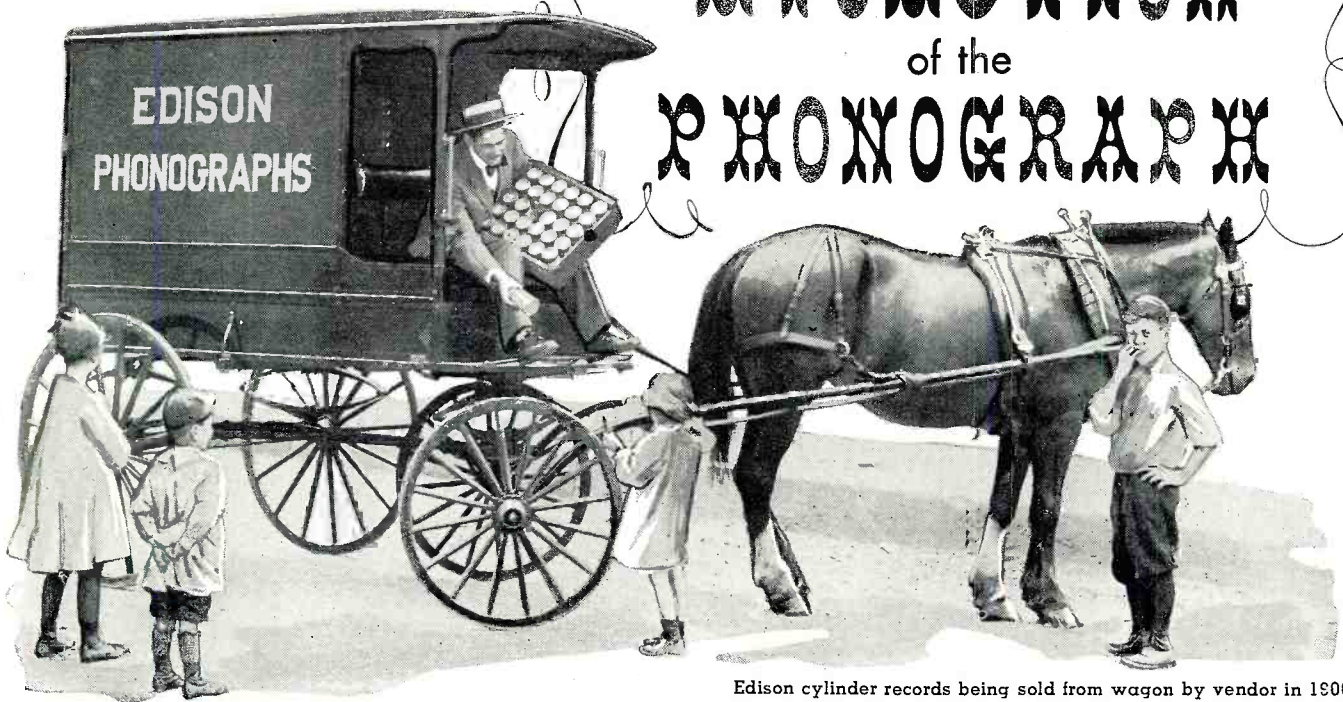

Edison cylinder records being sold from wagon by vendor in 1900.

Part 5. Continuing the story of the development of Edison's phonograph before the turn of the century.

Fig. 1. Edison's 1895 "Triumph" phonograph had a triple-spring type of motor.

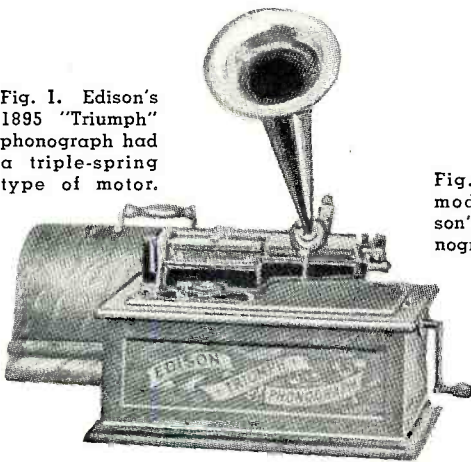

Fig. 2. Popular model was Edison's "Home Phonograph" of 1896.



IN PART 3 of this series we discussed Edison's original phonographs and the several varieties of the model "M" which he developed in the late '80's. These models were powered by wet batteries, by a hand treadle, by foot power, and by 110 volts from the direct-current house lighting circuits.

Tainter and Bell, in the meantime, had sought means for improving upon Edison's machines. As a result, competition again revived Edison's interest in his phonograph and he developed a spring-motor phonograph, known as the "Triumph" (Fig. 1), which was first sold in 1895. This was one of the heaviest models produced by Edison and weighed over 50 lbs. It employed the powerful triple-spring motor on shock-mounted suspensions, and would run noiselessly and with good regulation. Like other models to follow, this machine was supplied in an antique oak cabinet with cover to match and

Fig. 3. A detailed sketch and listing of component parts used in the Model A type of home phonograph.

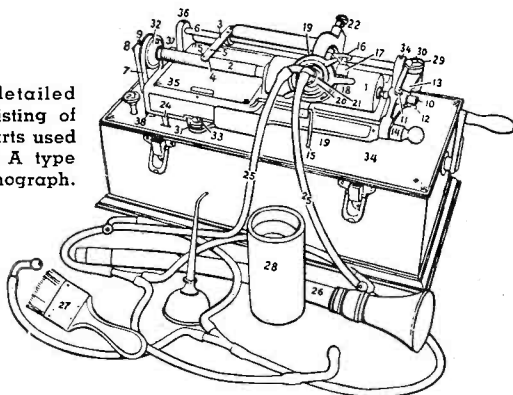

INDEX OF PARTS

- | | |
|---|---|
| 1. Brass Mandrel to hold wax cylinder (Assembled with Main Shaft) | 19. Speaker Clamps |
| 2. Main Shaft (Assembled with Brass Mandrel) | 20. Speaker |
| 3. Feed Spring | 21. Tube Plate |
| 4. Feed Nut | 22. Knife Adjusting Screw |
| 5. Feed Nut Screws | 23. Speed Adjusting Screw |
| 6. Back Rod | 24. Start-and-Stop Switch |
| 7. Drive Belt | 25. Hearing Tube |
| 8. Main-Shaft Center | 26. Speaking Tube |
| 9. Main-Shaft Center Set Screw | 27. Chip Brush |
| 10. Swing-arm Center | 28. Wax Cylinder, or Blank |
| 11. Swing-arm Center Set Screw | 29. Swing-arm Spring Washer |
| 12. Swing-arm Center Adjusting Screw | 30. Spring-Washer Set Screw |
| 13. Swing Arm | 31. Body-holding Screw Washers (metal and rubber) |
| 14. Lock Bolt | 32. Main-Shaft Pulley |
| 15. Lift Lever | 33. Body-holding Screw |
| 16. Speaker Adjusting Screw | 34. Top Plate |
| 17. Speaker Adjusting Screw Lug | 35. Home Phonograph Body |
| 18. Speaker Lever | 36. Back-rod Set Screws |
| | 37. Main-Shaft Pulley Set Screws |
| | 38. Body Cushions |

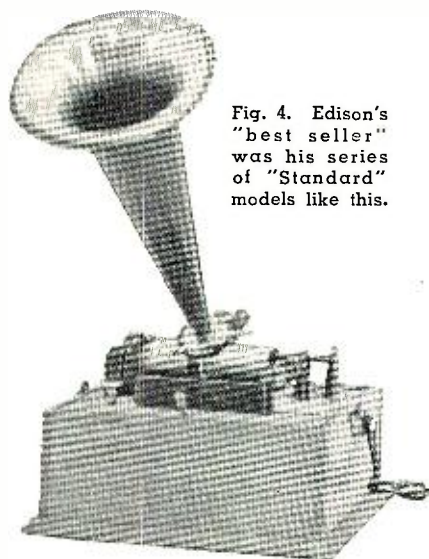
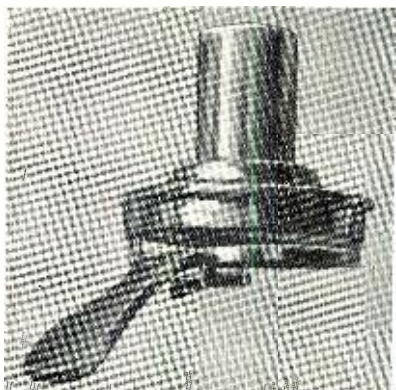

Fig. 4. Edison's "best seller" was his series of "Standard" models like this.



↑ Fig. 5. The Model C reproducer used a sapphire stylus shaped like a doorknob. (See Fig. 6.)



Fig. 6. Microphotograph of Edison's 2-minute sapphire stylus.



↓ Fig. 7. Recorder used glass diaphragm and sapphire cutter.



was finished in black and gilt enamel. The "Triumph" was able to play up to a dozen 2-minute cylinders at one winding. It was indeed a rugged mechanism and one which provided trouble-free service for many years.

All of the early Edison phonographs were suited to both recording and reproduction. A sapphire knife was contained in a small housing back of the tone arm assembly and this was used for shaving the wax cylinders so that they could be re-used. The cutter was made of sapphire and was shaped like a flat chisel. Altogether there were four distinct models of the "Triumph" manufactured. The first, model "A," was housed in a plain oak box which was provided with an accessory drawer. The only difference between the model "A" and the model "B" (Fig. 1) was in the design of the box. They were both made early in 1895.

The Edison Home Phonograph was first sold in the year 1896. This became one of the most popular of all of Edison's machines. The first in the series of three models of the Edison Home Phonograph (Fig. 2) was known as model "A." It was a single-speed phonograph designed for the 2-minute wax cylinder records which were standard throughout the late '90's.

All of these early machines were complicated by present standards. The detailed drawing (Fig. 3) identifies the many components comprising these early designs. All of the first machines employed a speaking tube for recording and a hearing tube for reproduction. By improving upon the design of the diaphragm of the reproducers, Edison soon discovered that there was enough energy created acoustically to warrant the use of a metal horn, so that more than one person could hear the reproduction at the same time. The earliest diaphragms were made of a special glass .004 inch thick and manufactured in France. This material was found to be superior to mica which had been used in experimental models. Standard accessories for the model "A" Home Phonograph are shown in Fig. 3.

Edison's "best seller" was his Stand-

ard model (Fig. 4), first produced in 1896. This machine, like the Home, was designed specifically for the 2-minute wax cylinder and used a model "B" reproducer. Edison was the first to employ a sapphire point (needle) on his reproducers and this was standard with all of the Edison machines until 1908 when he employed a diamond point for his improved cylinders. The Standard also had a shaving knife and used a single spring motor drive to play three or four cylinders at one winding. This model is still in plentiful supply and, because of this, its value to collectors of these early machines is rather limited.

Of particular interest is the adjusting nut which acted as a vernier and was capable of turning the reproducer in order to assure perfect tracking of the stylus in the groove of a cylinder.

The model "C" reproducer was developed shortly thereafter (Fig. 5), and this was designed to self-compensate to seat itself to the groove in the record. The stylus, of sapphire, was ground to a shape resembling a door-knob (Fig. 6), and contact was made on the lower side as seen in the illustration. Note a slight wearing of the sapphire at the point where it engaged the record.

The recorder supplied with the Standard (Fig. 7) also employed a thin glass diaphragm to which was attached a sapphire cutter mounted to a metal bar and cemented to the diaphragm. A telescopic assembly resembling a simple bellows was attached to the diaphragm and then coupled to the neck of the recorder to prevent loss of sound waves resulting from the vertical fluctuating action of the diaphragm assembly. The speaking tube and the hearing tube (Fig. 8) were standard equipment for this machine.

The next in the line of spring-motor Edison phonographs was the compact "Gem," manufactured in 1898. This was made in three different models. The first of these (Fig. 9) was the model "A." The one illustrated is shown with an accessory gear train which provided a choice of either 2- or

(Continued on page 179)



↑ Fig. 8. Hearing tube and speaking tube used prior to horn era.

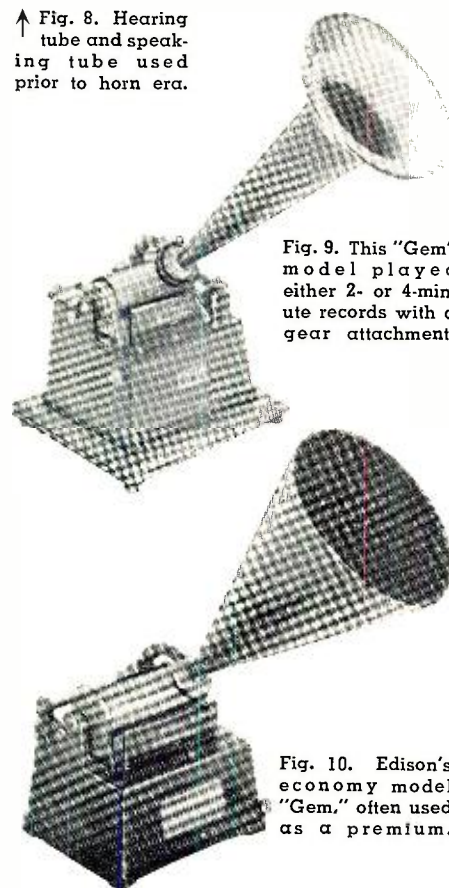

Fig. 9. This "Gem" model played either 2- or 4-minute records with a gear attachment.

Fig. 10. Edison's economy model "Gem," often used as a premium.

Servicing

Your V.T.V.M.

By

SOL HELLER

Allan B. Du Mont Labs., Inc.

and

PETER ORNE

Emerson Radio & Phonograph Corp.

Keep your v.t.v.m. working by learning to make these tests and repairs—applicable to other meters too!

THE vacuum-tube voltmeter is an essential piece of test equipment in the average service shop. If the service technician has to wait several weeks to get his v.t.v.m. repaired when it gets out of order, considerable inconvenience will often result and service time on certain jobs is likely to be increased. It is therefore desirable for the service technician to repair his defective v.t.v.m. himself, rather than send it back to the factory. Most of the needed repairs on service-type v.t.v.m.'s can be accomplished very rapidly, if the technician understands how the instrument works, and uses a logical troubleshooting approach.

The operation of a representative v.t.v.m. may be summarized briefly as follows: Two tubes are usually employed in a bridge arrangement (see Fig. 1). When no measurements are being made (i.e., no input voltage), the plate currents of the tubes are equal, and the cathodes of both are at the same potential to ground. No current flows through the meter movement, which is connected between the two cathodes through a variable resistor.

When a d.c. voltage test is to be made, the potential to be measured is applied between the grid of one of the tubes and ground. The plate current in this tube changes, since the bias of the tube has been altered; the plate current in the reference tube, however, re-

mains unchanged. A difference in the cathode voltages of the two tubes is set up that results in a potential difference across the meter movement, producing a current in it proportional to the applied voltage. Proper calibration of the meter scale permits it to indicate the applied voltage accurately.

For a.c. voltage measurements, a diode rectifier is employed to rectify the applied a.c. voltage. (Since the v.t.v.m. only measures d.c. voltages, an a.c. voltage must be converted to d.c.) The rectified voltage is applied to the active tube in the bridge circuit (see Fig. 2).

When a resistance measurement is to be made, a bias is applied to the v.t.v.m. active tube by means of a battery. The resistance to be measured connects into the circuit in the manner shown in

Fig. 1. Simplified diagram of the basic measuring circuit of a typical v.t.v.m. The meter movement may be connected as shown or between the plates of V_1 and V_2 .

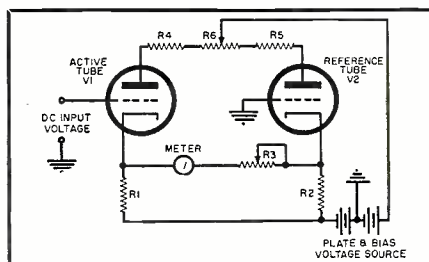

Fig. 3, and causes a change in the bias of the active tube. This change in bias produces a proportional change in current through the meter movement. The calibration of the ohmmeter scale on which this change is indicated is such that the unknown resistor's value is accurately measured.

For service purposes, the v.t.v.m. may be divided into eight sections. These are (1) the leads, (2) the switching system, (3) the bridge circuit, (4) the meter movement, (5) the power supply, (6) the battery and associated resistors used on ohms measurements, (7) the rectifier and associated balancing circuit used for a.c. voltage measurements, and (8), the special probes used for measuring high voltages and r.f. potentials.

The leads feed voltage or resistance information into the v.t.v.m. switching system. The latter includes the function switch which sets up the meter for the various types of measurements; and the range selector switch, which taps off a suitable percentage of the applied voltage from a voltage divider at the input of the active bridge-circuit tube (see Fig. 4). The voltage divider is necessary to keep the voltage input to the active tube down to a safe value. The higher the voltage to be measured, the smaller is the percentage of it that is fed to the active tube.

The bridge circuit creates the current difference that is measured by the meter movement. The movement is a D'Arsonval galvanometer-type unit. The power supply provides the voltages required by the various tubes.

Meter Troubles

Leads. When the pilot light indicator on the v.t.v.m. shows that power is getting to the instrument, but the v.t.v.m. is inoperative, the most likely trouble is a defective lead. To check the "hot" d.c. voltage lead, disconnect the lead from the meter and substitute an insulated piece of wire in its place. Connect one end of the wire to the "hot"

point of the jack on the meter; connect the other end to a source of voltage, such as a battery. Use the meter's ground lead to complete the circuit. If a voltage is read, the original meter lead is defective. The ground lead of the ohmmeter may be checked on the "ohms" setting by shorting it to the "hot" ohmmeter lead. If the meter reads zero, the lead is not defective. If the reading is "infinite," connect the "hot" ohmmeter lead to a screw on the metal case of the v.t.v.m. If a zero reading is now obtained, the ground lead is open. To check the remaining lead (a.c. or "hot" ohmmeter lead), remove it, and connect the ground lead to the jack from which this "hot" lead came. If the original ohms reading was "infinite," and it now becomes zero, the "hot" lead is defective.

A frequently overlooked point related to leads is the presence of an isolating resistor in the tip of the "hot" d.c. lead. The function of this resistor is the maintenance of a high input impedance to the meter. The value of the resistor is generally one megohm or more. On some meters, identical connectors are used on the "hot" d.c. and a.c. leads, making it possible for a sleepy technician to reverse the lead connections, and a.c. voltage readings will be too low in consequence. (The inaccuracy may be evident on all scales, or may be noticeable on low voltage ranges only, depending on the circuits used in the meter.) Resistance readings will be greater than normal by the amount of resistance in series with the lead. The presence of either symptom calls for a quick resistance check of the "hot" a.c. and "ohms" lead. The correct reading should, of course, be zero or nearly zero ohms.

Lead repairs are simple; some important points, however, are worth noting in connection with such repairs. First, remember the abuse leads are subject to, and don't rush the job. Two, be sure to provide proper strain relief and make secure mechanical connections before doing any soldering. If a new lead is to be made up, obtain suitable wire. Ordinary shielded wire is not flexible enough to provide satisfactory service.

The meter is inoperative on all function settings and the leads are normal. Turn the meter "off-on" switch off; after a minute or so, turn the switch on again. Keep your eye on the scale pointer. As the tubes in the bridge circuit heat up, the current through them varies more or less erratically; the pointer will indicate these variations by swinging either half-way up the scale, or possibly down below the zero point. This is a normal reaction, and indicates that the meter movement is working, the power supply is delivering heater and "B+" voltages to the v.t.v.m. tubes (even though these voltages may not be correct), and the bridge-circuit tubes are both passing some plate current. The source of trouble is thus narrowed down to a meter section other than the ones just referred to, with the likeliest site the input circuit of the

v.t.v.m. If the pointer does not budge, voltage checks in the power supply circuit and the points to which it feeds indicate the next step to be taken. A severe loss of emission in both bridge-circuit tubes, or a defective meter movement, may also be present.

If the meter's pilot light does not go on, tests of the power outlet, line plug, line cord, and "off-on" switch, in that order, are called for.

Meter does not "zero" on d.c. voltage setting. Before the v.t.v.m. is turned on, the technician should quickly note the position of the scale pointer. The pointer should register zero; if it doesn't, reset the mechanical adjustment screw that is generally provided on the plastic housing directly below the glass face of the meter until the pointer does indicate zero. Ideally, the pointer should remain at zero irrespective of whether the meter is upright, tilted, or in a horizontal position. Since the meter balance necessary to provide this ideal state of affairs is rarely perfect, it is advisable to zero the meter while it is in the position in which it is most often used, and to change this position as little as possible.

When the v.t.v.m. has been turned on, and a minute or two allowed for tube warm-up, note whether the pointer still registers zero. If it doesn't, set the function switch to "+D.C. Volts," short the d.c. leads together, and reset the zero adjust potentiometer until the pointer does read zero. This zero adjustment compensates for small changes in the characteristics of the tubes used in the bridge circuit. If the pointer cannot be brought to zero, mismatched tubes in the bridge circuit are the most likely source of the trouble.

One dual-purpose tube, such as a 6SN7, or two separate triode tubes are

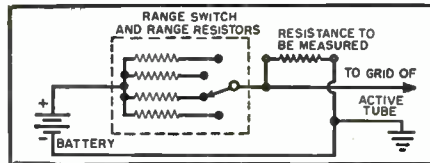

Fig. 3. Equivalent of the ohms measuring circuit of a v.t.v.m. The resistance to be measured is part of a voltage divider across the input to the active tube of the bridge circuit.

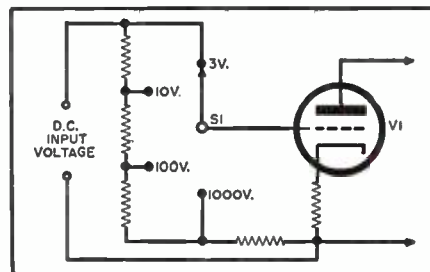

Fig. 4. Simplified diagram of the d.c. voltage divider at input of v.t.v.m.

used in the bridge circuit. When two separate triodes are employed, a quick test for tube trouble may be made by reversing the positions of the tubes. If one of the tubes is defective, the reversal will change the direction in which the pointer is off zero. If the meter pointer was above zero to begin with, for example, it will go below zero when the tubes are reversed. If a dual-purpose tube is present, the fastest test lies in substituting another tube. Irrespective of whether one or two tubes are used in the bridge circuit, a number of tubes should be substituted before trouble is looked for elsewhere.

When one of two bridge circuit tubes is defective, it is advisable to replace both, using tubes that are as closely

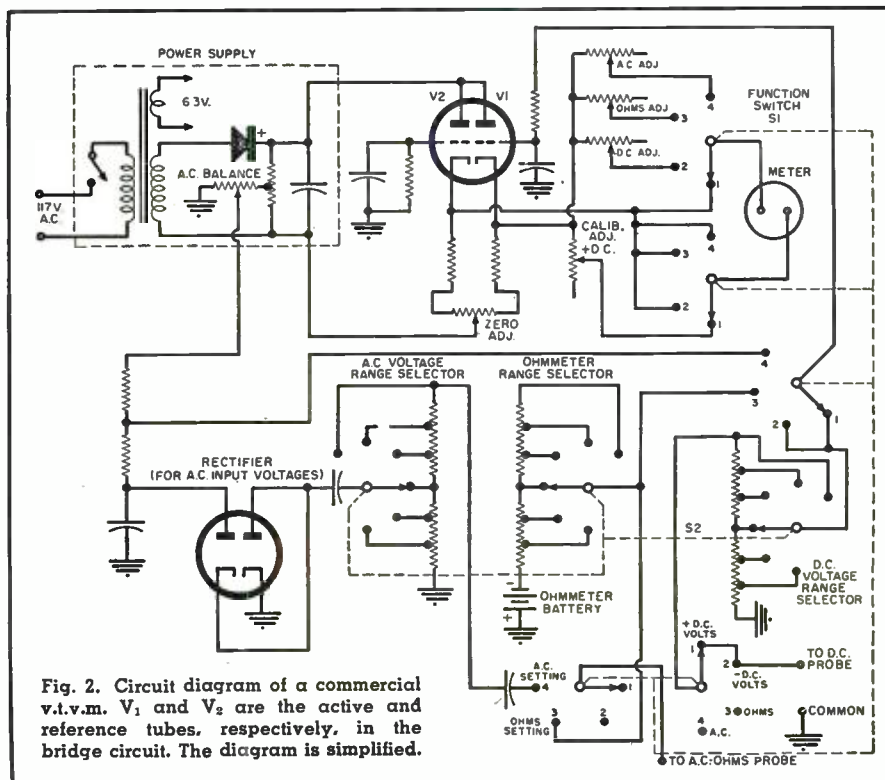

Fig. 2. Circuit diagram of a commercial v.t.v.m. V₁ and V₂ are the active and reference tubes, respectively, in the bridge circuit. The diagram is simplified.

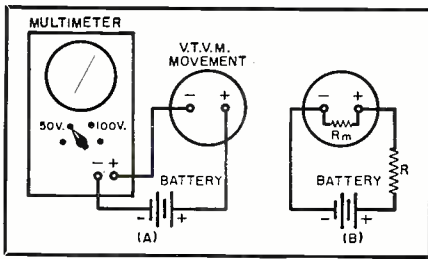

Fig. 5. Two methods of checking a meter movement are shown here. (A) Checking a movement against a meter known to be accurate; (B) checking by use of Ohm's Law.

matched as possible. New tubes of the same make and code number are likeliest to provide the necessary match.

Causes of trouble other than tubes that should be looked for when the pointer cannot be set at zero on d.c. volts include any component fault capable of upsetting the balance of the two triodes in the bridge circuit—i.e., a change in value of resistors used in the plate, grid, or cathode circuit of each tube, shorted or leaky capacitors in these circuits, etc.

Calibration adjustments. Adjustments for setting the pointer to zero volts are provided to eliminate inaccuracies due to differences in the characteristics of the bridge-circuit tubes. They are usually screwdriver adjusted potentiometers that become accessible only when the v.t.v.m. is removed from its case. The potentiometers vary the resistance in series with the meter movement (as shown in Fig. 2), thus adjusting the meter reading to the gain of the tubes.

The difference between the calibration and zero-adjust potentiometers is this: the zero-adjust pot simply balances one triode against the other, but does nothing to correct for over-all loss of gain in both of the tubes; the calibration adjust pots, however, do correct for such changes. Calibration adjustments should be made periodically—say, every two months; they should also be made whenever tubes are changed.

To make the "+ D.C." calibration adjustment, connect the d.c. leads to a fresh dry cell (1.55 v.) and set the "+ D.C." calibration pot to the point where the meter reads 1.55 volts. The same procedure is used for the "- D.C." calibration adjustment, with the exception that the leads to the battery are reversed, and the function switch set to "- D.C. Volts." (Some v.t.v.m.'s use one d.c. adjustment only.)

The a.c. calibration adjustment should be made with a low-voltage a.c. source applied to the v.t.v.m. input. Unfortunately, there is no convenient standard voltage source for a.c. comparable to a battery for d.c. The 6.3 volt heater supply to a tube may be used for this purpose (the heater circuit of a tube in the v.t.v.m. will serve), keeping in mind that this heater voltage depends on the value of line voltage present. The line voltage in most localities varies as much as $\pm 10\%$ and even more, during the course of a day. It is therefore desirable to check the v.t.v.m. reading on a.c. against the

reading of a voltmeter known to be accurate.

Ohmmeter adjustment troubles. If the pointer cannot be brought to the "infinite" limit of the scale by suitable manipulation of the ohms adjustment control, the meter battery has aged and needs replacement. If the pointer deflects backward after the battery replacement, the battery has been connected in reverse polarity.

Meter readings are incorrect. If improper readings are obtained on all function settings of the v.t.v.m. the most likely sources of trouble are: the power supply, severe loss of emission in both tubes, or a defective meter movement. When the v.t.v.m. has been removed from its case, a visual check should be made. Note whether glass tubes are lit or metal tubes are warm. Note also whether any charred resistors are present.

If the preliminary visual check reveals nothing abnormal, the "B +" voltage should be measured. (The service technician should check the "B +" supply and other voltages in his v.t.v.m. while the instrument is in good working order so that he won't have to guess what these voltages should be when the meter is not operating normally.) Most v.t.v.m.'s provide "B +" and "B -" voltages. The highest "B +" voltage may be between 30 and 100 volts; there may be that much "B -" voltage present as well. The normal voltage between plate and cathode of a tube may be as low as 25 volts or as high as 100 volts. The output of the power supply may be between 100 and 300 volts.

The fact that a transformer is used in the meter doesn't mean that the line voltage is being stepped up; the transformer is required for isolation purposes, and prevents the line short that would occur if a v.t.v.m. with a "hot" chassis was connected to an a.c.-d.c. "hot"-chassis receiver whose chassis was at ground potential. (As it is, a line short in a v.t.v.m. is generally caused by a wearing away of the insulation of the line cord at the point where it enters the case.)

It should be kept in mind that the meter compares the current of two identical tubes. If the "B +" voltage drops somewhat, the currents through both tubes will fall, but the current difference will remain the same. This is a desirable feature of v.t.v.m. design, since it makes the readings fairly independent of line voltage variations. It also simplifies the troubleshooting of the power supply, since only severe changes in "B +" voltage will impair v.t.v.m. operation. Very marked deviations from the normal should therefore be looked for, in measuring "B +" voltages.

When the meter can be "zeroed" (on d.c. volts), trouble at some circuit point common to both tubes should be suspected. If the meter cannot be "zeroed," the voltages at the electrodes of one bridge tube can be checked against the corresponding electrodes of the other tube. The point at which a differ-

ence shows up will indicate the site of the trouble.

Checking the meter movement. When the v.t.v.m. is inaccurate or inoperative on all functions, and tests fail to reveal a defect in other sections, the meter movement should be checked. One way of doing this is to compare it with a similar movement. Most modern v.t.v.m.'s use a 20,000 ohms-per-volt (50-microampere) meter movement that is practically identical with the movement used in many conventional multimeters. If such a multimeter is available, proceed as follows:

Disconnect the movement to be tested from its circuit. Then connect it in series (see Fig. 5A) with a d.c. voltage source (such as a battery) and a multimeter. The pointer of the v.t.v.m. movement will deflect the same amount as the multimeter pointer (since the same current flows through both movements) permitting a check of the v.t.v.m.'s accuracy to be made.

Another way to check the v.t.v.m. meter movement is as follows: Calculate the resistance required in series with a battery to produce half-scale deflection on the movement. This is readily done by using Ohm's Law ($I = E/R$). Suppose the v.t.v.m. uses a 200-microampere movement. One hundred microamperes will be present at half-scale deflection. Assume a 1.5-volt battery is to be used as the voltage source. Then, $.0001 = 1.5/R$ and $R = 15,000$ ohms. Connect the correct value of resistance in series with the movement and the d.c. voltage source (see Fig. 5B), and see if the meter reads half-scale. If the reading is less than half scale, the possibility that the internal meter resistance is excessively large must be considered. To verify this, double both the voltage and the resistance (using 3 volts for E and 30,000 ohms for R); if the new reading is the same as before, the meter movement resistance is negligible. If the two readings differ considerably, the reading which would have been obtained with zero movement resistance can be calculated from the formula:

$$I = (I_1 \times I_2) / (2I_1 - I_2)$$

where I_1 is the first reading, I_2 is the second reading, and I is the reading that would be present if the meter movement resistance was zero.

Meter movement troubles and their repair. If the reading obtained during the previously described test is inaccurate, but the pointer doesn't stick or jump erratically, the movement should be returned to the factory for repairs. A damaged hairspring or magnet, or a defective winding is probably present; none of these can be conveniently repaired with the equipment available in the average service shop. The erratically moving, sticking, or bent pointer can be repaired.

Sticking is generally caused by one of the following: The pointer may be touching the glass or the scale, because it is bent or because the glass has been pushed in too far. A tiny piece of metal (originally introduced at the time of

(Continued on page 140)

Flying TV Service

By DEAN SMITH



The aerial view shown here was taken from Whitey's T-V Service "flying ambulance" and shows one of the towns visited every week for regular service calls. The truck on the right is used to survey a customer's locality for the best spot to erect a TV receiving antenna. The "Tri-Pacer" shown above is used by Whitey's T-V Service to reach small towns out West.

W. (WHITEY) BRAYER of Phoenix, Arizona, is a man who believes in creating his own opportunities. Television-hungry residents of Arizona's most remote communities are everlastingly grateful that he is.

Brayer, a former Air Force communications officer, now operates one of the West's largest television repair businesses—*Whitey's T-V*. His three-pronged plan of attack for obtaining business in the state's outlying areas consists of installing a community service antenna on a mountain top, selling television sets to residents of the area, and maintaining a flying "TV Ambulance" that provides weekly service in towns not large enough to support a permanent television repair shop.

Brayer and his wife now own a "Tri-Pacer" airplane and both have become accomplished pilots. They plan to add a second plane to their "private air force" in 1956. Whitey's schedule now takes him to Ajo, a mining town 150 miles southwest of Phoenix, on Tuesdays; to Douglas and Bisbee near the Mexican border on Wednesdays and Thursdays; and to Williams, 150 miles north of Phoenix, on Fridays.

"We can leave Phoenix at 8 a.m., make as many as 18 service calls, and be back at regular quitting time," Brayer explains. "Our customers bring their sets to a central collection point in each of the communities we visit. Because we are able to go and come back the same day, we don't have to work men overtime and it's not necessary to make additional charges for the service. Our rates are the same as in Phoenix."

Up to two years ago, Brayer was a conventional sort of television dealer and technician. How did he get into this "TV missionary work" that takes him flying all over Arizona?

It all started when the residents of a

This unusual operator first creates a TV market in small mountain-locked towns and then flies in to service sets.

tiny community near Williams, Arizona, decided they wanted television reception. The 17 families composed the entire population of a settlement of *El Paso Natural Gas Co.* employees who maintain a pumping station. At their request, Brayer drove to the community with his antenna tower truck and took signal strength readings in the area. There was no usable signal, so he installed a television receiver in the back seat of his airplane and began flying low over surrounding mountains to determine the best location for a community service antenna. He finally decided on a 6700-foot mountain called "Microwave Hill," six and a half miles from the pumping station and its 17 homes. Even though signal strength readings on "Microwave Hill" were in the 15-30 microvolt range, the absence of noise in the area made the site usable.

Brayer considered several antenna possibilities, but decided to use a four-stack yagi, connected in an H-frame. The antenna picks up signals from three channels in Phoenix and feeds them to a preamplifier. Open-wire line carries the signal to the subscribers' homes.

As soon as the gas company employees had their television system in operation, people from Williams, 10 miles away, started driving out to the little community to watch programs. It was only a matter of months before Brayer was erecting a community antenna system for Williams, one which was completed in only two weeks.

Brayer uses his airplane in many ways to speed the antenna installations and cut costs. First, he finds the best antenna site by flying around the area with a test set in the plane. Then

he uses the plane to map the easiest routes by which equipment can be trucked in. And, finally, he flies in urgently needed installation parts and, later, repair equipment.

Of particular pride to Brayer is the two-way radio communications equipment he maintains between his plane, his office, and his service trucks. He is in contact several times daily with service companies he has set up in towns served by his community antenna systems, arranging the calls he will make on his next trip. Even while en route to an outlying town he can accept last-minute service requests.

In his "flying ambulance," he carries standard TV repair equipment found in most repair trucks, including a field strength meter, vacuum-tube voltmeter, tube caddy, and most common capacitors and resistors. Other parts are stocked at the towns he visits, and major components can be flown in from Phoenix.

By the end of 1955, Brayer had installed community antenna systems at the natural gas community, at Douglas, and at Williams. His plans call for additional installations in two other Arizona communities and one in eastern California. In each antenna installation project, Brayer learns something new about equipment and procedures. He attacks the problems with all the zeal of a research scientist and is eager to try new ideas. Next on his list is the use of microwave relay stations to bring television into remote communities.

Brayer gets a terrific boost out of bringing entertainment to people previously out of TV range. And the additional business isn't hard to take, either.

-30-

By LOUIS E. GARNER, JR.



A Review of Servicing Techniques

Most technicians know the procedures described but have forgotten how useful they can be on a "tough case".

MANY radio-television technicians, through habit, tend to standardize on two or three diagnostic methods, even though other techniques are available and, in some cases, to be preferred. For maximum efficiency the technician should be thoroughly familiar with all the basic techniques and should be prepared to use the one best suited to the equipment being serviced and the complaint encountered.

A ready knowledge of various servicing techniques is valuable in another way. Sometimes an unusual defect cannot readily be detected with the first technique used. In such cases, considerable time may be lost trying to isolate the trouble if another effective technique is not known. Fortunately, for each common complaint, there are several good techniques that may be used.

In order to adequately discuss the application of various techniques to actual servicing problems, we will first review, briefly, each basic diagnostic method.

Basic Servicing Methods

Effect-to-cause reasoning: This is the most basic and the most important of servicing techniques. Experienced technicians often use this technique almost exclusively, relying on the other techniques only for confirmation or in cases involving unfamiliar circuits.

To use "effect-to-cause reasoning" a knowledge of circuit operation is mandatory. The technician first confirms the complaint then, on the basis of his knowledge of circuit operation and

perhaps with a simple test, decides in which section or stage the defect is located. Often, even the defective part is determined.

A final test is then made, generally using a multimeter, either to finally isolate the defective part or to confirm the diagnosis.

This technique depends on the fact that each complaint is brought about by a specific cause. Sometimes several possible defects might result in the same complaint. In such cases, the technician relies on his past experience to choose the most likely defect for his first test.

When developed properly, this technique enables a technician to determine the one or two most likely defects causing a specific complaint simply by examining the schematic diagram and having the complaint described.

Testing tubes: Although "testing the tubes" is a service technique that may be used even by an apprentice technician, the fact remains that this technique, in terms of sets serviced, is probably one of the most important.

A good percentage of all complaints are due to nothing more than a defective tube or tubes. Occasionally, the customary test with an emission-type tube tester will indicate a tube to be "good" even though the tube is defective. In such cases, the most reliable test is substitution of a tube known to be in good operating condition.

TV technicians, particularly, will carry a fairly complete assortment of tubes on house calls so that a substitution test may be easily and quick-

ly made. If the suspected tube is found to be at fault, the replacement is simply left in the set.

Alignment: Alignment is generally considered a repair method rather than a diagnostic technique. However, there are many cases where re-alignment of the receiver may offer the only means of eliminating a possible cause of trouble.

The author encountered such a condition in a 1946 model RCA television receiver. The complaint was a narrow black bar across the middle of the TV screen, together with excessive hum. Tests indicated that the condition always seemed to be present in some degree, but was aggravated when a station was tuned in. When an oscilloscope test indicated the interference signal to be 60 cycles, tube heater-to-cathode leakage or a defective bypass capacitor was suspected.

Shorting the output of the front-end eliminated the condition, so tests were concentrated in this section of the receiver. However, testing all parts and tubes and even trying substitute tubes failed to isolate the defect. Finally, almost in desperation, re-alignment of the front-end and i.f. stages was tried. This completely cleared up the trouble.

Further tests isolated the reason for this odd condition. The i.f. stages and the front-end were so badly misaligned that over-all oscillation was taking place. However, the oscillation was "blocking" at a 60-cycle rate, still permitting signals to be received but superimposing the heavy 60-cycle pulse signal on all incoming signals.

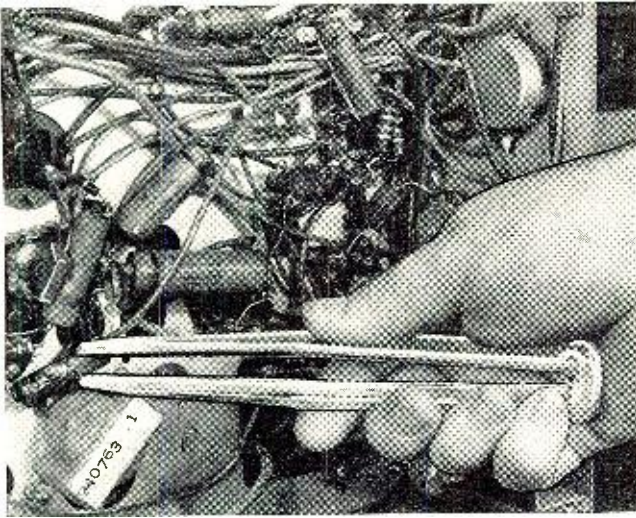

Fig. 1. In the "brute force" servicing procedure, a pair of plastic tweezers is used to spot a stubborn intermittent by causing defective part to cut out.

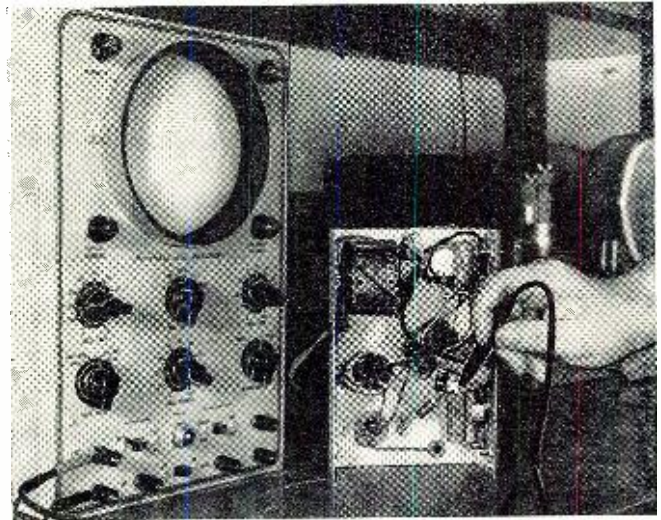

Fig. 2. Here the standard "signal tracing" technique has been slightly modified by the addition of a scope to the test equipment line-up. See article on this.

While the situation just outlined is unusual, it does serve to point out the importance of alignment as a service technique in itself.

Voltage analysis tests: Once popular, this technique has fallen into disfavor with the advent of more rapid testing methods. When using this technique, the operating voltages on each electrode of every tube are measured and compared against a chart of "normal" operating voltages as supplied by the set manufacturer. Any discrepancies indicate the stage where the defect exists.

To properly use this technique, the technician must either know the normal operating voltages or have such information available.

Today, voltmeter tests are used primarily to isolate a defective part once the defective stage has been isolated by other methods.

Ohmmeter tests: Resistance tests (systematic checks between established points in the equipment) once were considered as important as voltage analysis. The technique is much the same, except that an ohmmeter is used for the measurements, set power is off, and resistance readings are taken.

Like voltage analysis, this technique has fallen into disuse as a diagnostic method and now is used primarily to identify a defective part. This technique is probably less used than voltage analysis at the present time, since many manufacturers continue to supply charts giving the "normal" d.c. operating voltages while resistance charts are rarely furnished.

"Brute force": This is a specialized technique, used primarily in the case of intermittent receivers. Although an old technique, it still proves to be one of the most effective in isolating an intermittent part or connection.

To use the technique, a pair of plastic pliers or tweezers is used to move, pull, and "wiggle" the various components while the set is operating. See Fig. 1. If the intermittent condition

can be made to occur as a particular part or wire is moved, the defect has generally been isolated. A defective part or wire can be replaced or a poor connection may be resoldered.

Stage blocking: This is another specialized technique, used generally when hum, noise, interference, or oscillation is present. A short piece of hookup wire or a test lead is used to short the grid of each stage to its cathode temporarily. A single stage is tested at a time and the test generally carried out systematically, working either from the front-end towards the output stage or *vice versa*.

If the hum or noise disappears as a particular stage is "blocked" in this fashion, but is present when the preceding stage is "blocked," the trouble has been isolated to a single stage.

When using this technique, care must be taken that stage bias is not removed long enough to damage the tube. This is especially true as far as power stages are concerned.

Signal tracing: Probably one of the most effective servicing techniques, applicable to isolating most troubles and yet easily used even by a moderately skilled technician, signal tracing is generally carried out with a specialized instrument. The basic principle is simply that of checking the signal amplitude and quality at various points in the equipment, starting at the input or front-end and working systematically, stage-by-stage, towards the output.

The simplest of signal tracers is nothing more than a pair of earphones used to check the signal at various stages in an audio amplifier. More advanced signal tracers incorporate a high-gain audio amplifier, a loudspeaker, level indicator (tuning eye or meter), and an r.f. detector probe for signal tracing in i.f. and r.f. stages. The most expensive instruments also incorporate t.r.f. stages for the greatest effectiveness in checking i.f. and r.f. sections.

An oscilloscope may be used to check

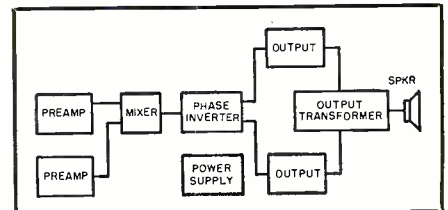

Fig. 3. Block diagram of a more or less standard audio amplifier. Refer to text.

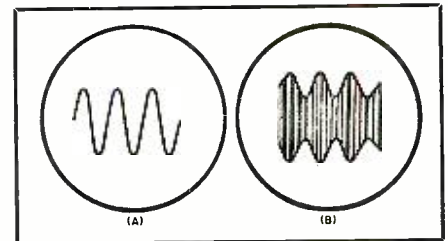

Fig. 4. (A) Hum signal as observed on oscilloscope with horizontal sweep at approximately 20 cps. (B) Hum modulation of high-frequency audio signal. Sweep at 20 cps.

signal waveforms or to check sync pulses and sweep signals in a TV receiver as shown in Fig. 2.

Signal injection: This technique is just the opposite of the signal tracing technique and is just as satisfactory for isolating most defects. To use this technique, a known signal is introduced at various stages in the equipment as a substitute for the normal signal. The effects are noted and any trouble isolated to a specific stage.

As an example, if the complaint is "modulation hum," and an i.f. signal

Fig. 5. The various sections of a typical radio receiver. Note similarity to Fig. 3.

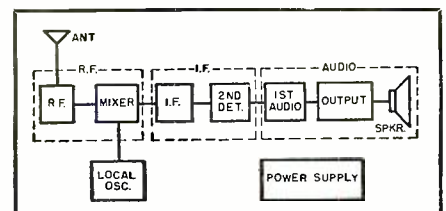

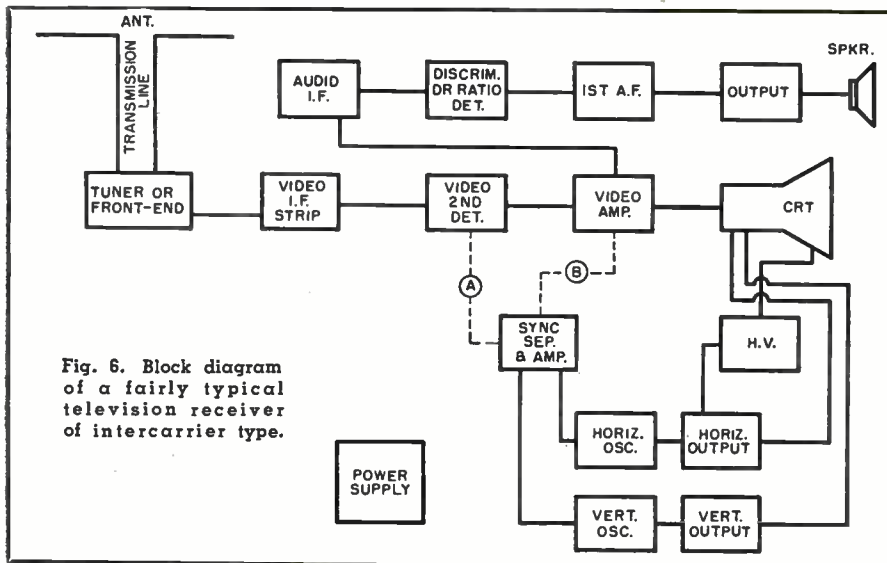

Fig. 6. Block diagram of a fairly typical television receiver of intercarrier type.

introduced into the second i.f. stage does not produce the complaint, but the same signal introduced into the first i.f. stage does, the defect is in the first i.f. stage.

A signal generator is generally used to carry out the *signal injection* test technique, with an audio signal used in the audio stages of the equipment and an i.f. or r.f. signal used in the i.f. amplifier stages and the front-end, respectively.

Circuit disturbance test: This technique is essentially a modification of the signal injection technique in which shock excitation (noise) is used in place of a regular signal. The technique is generally used when the equipment is "dead" or "weak" but may sometimes be used with intermittent receivers.

To use the technique, stages are "disturbed" one at a time, starting at the output and working towards the

front-end. This may be accomplished by momentarily touching the grid terminal with a finger, removing and replacing a tube in its socket, or removing and replacing a grid top cap. In sets where series heater strings are used, either the first or last method is used; removing a tube in such a set would disturb all stages rather than just the desired stage.

In an ordinary receiver, as each stage is disturbed, clicks, noises, or hum should be heard in the loudspeaker. If the signals are not heard as a particular stage is disturbed, that stage is dead.

Applications

The diagnostic techniques outlined may, with but slight modification, be applied to practically any type of electronic equipment requiring servicing, whether the equipment be a simple two-tube audio amplifier or a complex

piece of industrial electronic equipment. However, the average technician specializes in only three types of equipment, so we will discuss the general application of these techniques to those items—the audio amplifier, the radio receiver, and the television receiver.

The audio amplifier: Fig. 3 is a block diagram applicable to most audio amplifiers. This diagram covers most amplifiers encountered in phonograph and p.a. work, although somewhat simpler circuits may be used occasionally (single-ended output instead of push-pull, for example).

The defects generally encountered are "dead" amplifier, weak, noisy, intermittent, hum, oscillation, or distortion. The applicable techniques follow:

Dead: The defective stage may be isolated by signal tracing, using another audio amplifier; by signal injection, using either the circuit disturbance method or an audio oscillator as a signal source. If due to defective tubes, tube testing will isolate the trouble quickly. Voltage tests work in some cases and may often be used to isolate a defective part after stage isolation by signal tracing or signal injection. An oscilloscope or a.c. vacuum-tube voltmeter may also be used in signal tracing.

Weak: A defective stage may be isolated by signal tracing, signal injection, tube testing, and voltage tests. The trouble is usually caused by an open coupling capacitor, weak tube, or incorrect (low) "B" voltages. The oscilloscope, used with a voltage calibrator to measure stage gain, provides a powerful modification of the signal tracing technique to isolate a weak stage.

Noisy: Use signal tracing or signal injection. Stage blocking works well in some cases. If a "noise test" provision is available on the tube tester used, testing tubes will eliminate these as a possible source of trouble. Look out especially for noisy resistors, open bypasses, and defective shielding.

Intermittent: The "brute force" technique works best when trying to isolate an intermittent part or connection.

Hum: Signal tracing, signal injection, and stage blocking tests all work well for isolating the cause of this complaint. See Fig. 4. A 60-cycle hum is generally caused by heater-to-cathode leakage in a tube, an open grid, unbalanced rectification, or defective shielding. A 120-cycle hum is generally caused by defective filter capacitors in the power supply.

Oscillation: If over-all, stage blocking works well in most cases. If confined to a single stage, signal tracing provides an effective method for isolating the trouble. It is generally caused by defective bypass capacitors, defective shielding, or improper lead dress.

Distortion: Signal tracing or signal injection may be used to advantage (Continued on page 157)

Fig. 7. Summary of the various service techniques and their specific applications.

TECHNIQUE	COMPLAINT						
	DEAD	WEAK	HUM	NOISE (INTERFERENCE)	DISTORTION	OSCILLATION	INTERMITTENT
EFFECT-TO-CAUSE REASONING	✓	✓	✓	✓	✓	✓	✓
TESTING TUBES	✓	✓	✓	✓	✓	✓	✓
ALIGNMENT	✓	✓		✓	✓	✓	
VOLTAGE ANALYSIS	✓	✓			✓	✓	✓
OHMMETER TESTS	✓	✓			✓	✓	✓
"BRUTE-FORCE"				✓			✓
STAGE-BLOCKING			✓	✓		✓	
SIGNAL TRACING	✓	✓	✓	✓	✓	✓	✓
SIGNAL INJECTION	✓	✓	✓	✓	✓		✓
CIRCUIT DISTURBANCE	✓	✓					✓

Advanced
engineering
and precision-
manufacture
build

LONG LIFE

into RCA

RECEIVING TUBES



A receiving tube that delivers, and keeps on delivering at maximum performance levels doesn't just happen—it *has to be made to happen!*

Stringent quality control checks govern each part and each process in the manufacture of all RCA Receiving Tubes. Take the RCA-6AU6, for instance: The control grid is silver-plated to minimize grid emission and to give low contact potential; carefully processed cathode materials minimize leakage and mica support is specially treated to insure low inter-electrode leakage; result—Long Life! To insure noise-free performance—is “receiver-tested.” Avoid costly callbacks—standardize each tube on RCA. Tell your distributor to fill your tube order with RCA Tubes only.



RECEIVING TUBES
RADIO CORPORATION OF AMERICA

Your choice of school
is highly important
to your career in



**INDUSTRIAL
ELECTRONICS**



RADIO



TELEVISION

Become an
**ELECTRICAL
ENGINEER**
or an
**ENGINEERING
TECHNICIAN**
at

MSOE in Milwaukee

Choose from courses in:
ELECTRICAL ENGINEERING
Bachelor of Science degree in 36 to 42
months with a major in electronics or
electrical power.

ELECTRICAL TECHNOLOGY
Engineering Technician certificate
in 12 months in electronics, radio, or
electrical power;

Associate in Applied Science degree
in 18 months in radio and television.

TECHNICAL SERVICE
Service certificate in 6 months in electric-
ity; in 12 months in radio and television.

MSOE — located in Milwaukee,
one of America's largest indus-
trial centers — is a national
leader in electronics instruction
— with complete facilities,
including the latest laboratory
equipment, visual aid theater,
amateur radio transmitter —
offers 93 subjects in electrical
engineering, electronics, radio,
television, electrical power,
and electricity.

Advisory committee of lead-
ing industrialists. Courses
approved for veterans. Over
50,000 former students.
Excellent placement record.



TERMS OPEN APRIL, JULY,
SEPTEMBER, JANUARY

Choose wisely — your
future depends on it. Write
for more information today!

MILWAUKEE

SCHOOL OF ENGINEERING
Dept. RTN-356 1025 N. Milwaukee St.
Milwaukee 1, Wisconsin

Send FREE career booklets on:

Electrical Engineering Radio-Television

I am interested in.....
(Name of course)

Name..... Age.....

Address.....

City..... Zone..... State.....

If veteran, give discharge date.....

MS-31

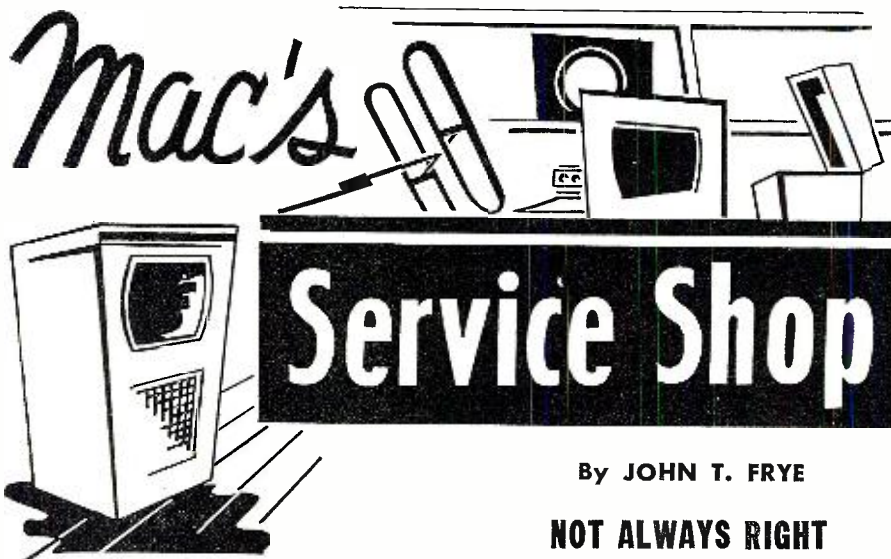

By JOHN T. FRYE

NOT ALWAYS RIGHT

"THAT portable record-player looks pretty new to be in the shop for repair already," Barney remarked as he watched Mac carefully place a blanket underneath the fine leather case of the instrument to prevent its being scratched by stray bits of solder on the service bench before he started removing the motorboard carrying the three-speed mechanism.

"It's a brand new birthday gift that's not even been presented yet," Mac said.

"Just proves they don't build 'em like they used to, huh?"

"Not necessarily. Nothing's the matter with this player. I'm simply going to do a little conversion job on it to add to its usefulness."

"What kind of a conversion job?" demanded Barney, who had all the curiosity of an old maid bluejay.

"I'm going to install a midget closed-type 2-circuit phono jack in a corner of this motorboard. The leads from the pickup go to this jack so that when the jack is empty they connect to the input of the player amplifier in the normal manner. However, when a phono plug is inserted into the jack, the 'hot' lead from the crystal cartridge is disconnected from the input of the amplifier and goes instead to the tip of the phono plug, and the 'ground' lead of the cartridge connects to the sleeve of that plug."

"I don't get it."

"It's quite simple. Next I make up a patch cord from about five feet of microphone cable with a phono plug on one end and a phono tip plug on the other. When the phono plug of this cord is inserted into the jack of the record player and the phono tip plug is inserted into the 'phono' jack of a radio or TV set, the portable player can be heard through the amplifier and speaker of the set. At the same time, the amplifier and speaker of the record player itself is silenced."

"So what?"

"So advantage can be taken of the larger speaker and more powerful amplifier normally found in radios or TV sets in listening to records played on

the portable record player. Many radios and TV sets are equipped with phono jacks, and the records sound far better when played through them. What's more, there are a lot of older radio-phonograph combinations sitting around practically unused because the TV set has usurped their place in the living room and their single-speed turntables will not play the popular 45 and 33 rpm records. Quite often, though, these sets have audio systems capable of quite good reproduction when a modern pickup is fed into them. With most of these combinations, you have only to pull out the plug on the end of the shielded lead coming from the 78 rpm turntable and insert the patch cord from the portable player. This gives these fine old sets an entirely new lease on life.

"At the same time, whenever you wish to use the player for purely personal listening wherein neither audio power nor high fidelity is essential, all you have to do is remove the patch cord and the player is ready to go. There are no awkward dangling cords, and nothing has been done to detract from the appearance of the record player. I've performed this operation on several portables lately, and the owners are very happy with the result. In fact, the owner of this player heard about the conversion from another customer and wanted it performed on this fine little phonograph before he presented it to his daughter."

"Sounds like a real cool idea, man," Barney approved. "You can have your music for dancing through the rumpus room radio and still take it with you!"

"There's only one thing to watch. A few of the portable players may use a 'hot' chassis with one lead from the cartridge connected to it. In that case, the lead should be transferred from the chassis to the frame of the phono jack, and a .05 μ fd., 600 volt capacitor should be connected between the jack frame and the chassis. This prevents danger of serious shock or of shorting out the line voltage when connecting the record player to a grounded radio chassis."

"Oh, oh!" Barney exclaimed in a low

voice. "Don't look now, but here comes that old grouch, Elmer Hinkle. Let's take to the hills!"

Barney's attitude was not without reason. Elmer Hinkle was a typical grouch, tight as a roll of *Scotch* tape and suspicious of everyone. He marched straight on back to the service department, carrying a small radio in the crook of his skinny arm. On his face was an agonized distortion of normal features that he fondly believed was an ingratiating smile.

"Mac, my friend," he began briskly, "I had a little argument with some of the boys over at the garage, and I'd like to know if I was right."

"What about, Elmer?" Mac asked warily.

"I was saying you told me very little of your charges was for what you actually *did*. You said the work involved was simply snipping wires and doing a little soldering. What you charged for was the use of your instruments, your experience, and your know-how in locating the trouble with a set. Was I right?"

"Why yes, Elmer; I guess you were. I did say something like that."

"Good!" Elmer exclaimed as he permitted his facial muscles to relax into their normal sour expression. "That's what I wanted to hear, and you're not going to wiggle out of it. You there, boy; you're a witness."

"Witness to what?" Barney demanded belligerently.

"Witness to the fact he can't charge me more than fifty cents for fixing this radio," Elmer said triumphantly. "He don't need to use his instruments or his experience or his boasted know-how because I've already found out what is wrong with my set. All I want him to do is solder in this new distributor that my nephew got for me," he said as he pulled a cartridge-type filter capacitor from his coat pocket and brandished it under Mac's nose.

"How do you know it needs a new 'distributor,' as you call it?" Mac asked as he placed the little receiver on the service bench and plugged it in.

"My nephew, who learned all about radio in the Navy, told me it did," Elmer boasted; "and he's forgot more about radio than you'll ever know."

"I hear nothing wrong with it," Mac said, trying hard to keep his temper, although Barney could see that the back of his neck was turning red.

"Wait a few minutes and you'll hear it hum like a bumblebee," Elmer said; "but I'm warning you I'm not going to pay for any of your phony diagnosing. I already *know* what's wrong. Just go ahead and do like I told you."

Sure enough, as the set continued to operate a noticeable hum appeared and quickly grew worse.

"I don't think—" Mac began.

"You're darned tootin you don't!" Elmer interrupted. "That's what you want to charge me for. Quit stalling and put in that new distributor."

Mac's lips drew into a thin line, and he quickly removed the set from its cabinet. In a couple of minutes he had

... another
MALLORY
service-engineered
product

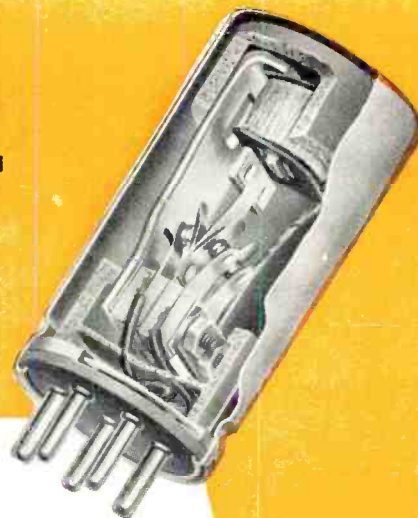

There's *extra life* in this **NEW MALLORY** Vibrator

Contact "bounce" and chatter are eliminated in this latest Mallory self-rectifying vibrator. New dual spring design is the reason. This construction gives clean make-and-break, and provides dynamically balanced self alignment.

COUNT ON THEM FOR LONGER LIFE,
and freedom from occasional early failure... for extra service *without* extra cost.

COUNT ON MALLORY,
leader in vibrator progress, for continued improvements in performance of all types of vibrators.

Your local Mallory distributor is stocked with the new vibrators, in both shunt drive (shown here) and separate drive models. Order from him now... and make these your standard replacement for all commercial jobs needing self-rectifying units.

P. R. MALLORY & CO. Inc.
MALLORY

P. R. MALLORY & CO. Inc., INDIANAPOLIS 6, INDIANA

- Capacitors
- Controls
- Vibrators
- Switches
- Resistors
- Rectifiers
- Power Supplies
- Filters
- Mercury Batteries

Engineering Writing

at **HUGHES**

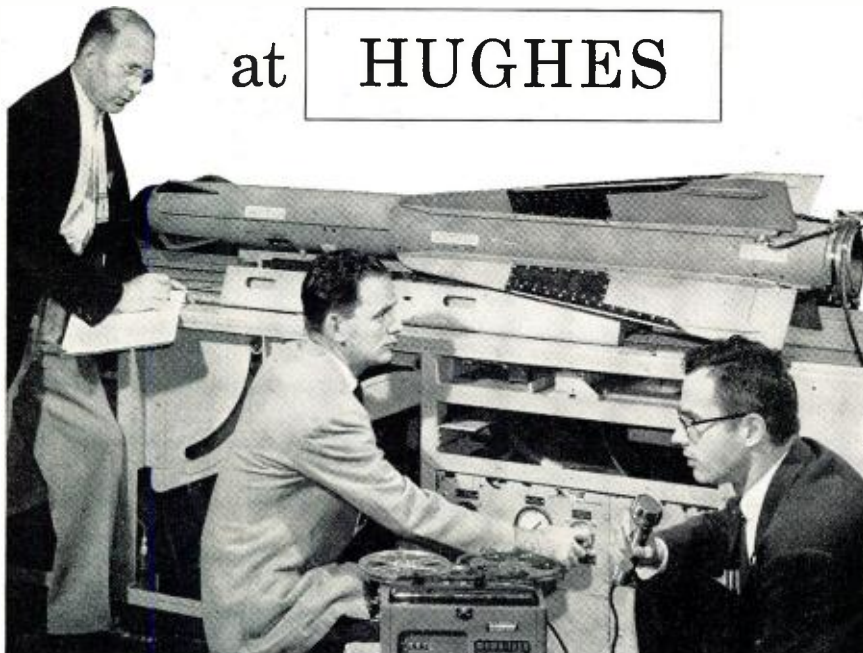

An engineering writer is that rare combination of a man so technically informed that he knows every detail of a given piece of equipment—and also is able to present a clear, concise, written description of its operation and performance.

Engineering writers at Hughes Research and Development Laboratories are as important to the team effort on any project as the engineers with whom they work in close cooperation. This is because the handbooks and other material created by engineering writers are *products*—just as are antennas, modulators, synchronizers and other electronic items.

The writers' products include Hughes equipment operating instructions; pilot and radar operator instruction manuals; service instruction books; test equipment use and service manuals; illustrated parts catalogues. Tape recorders are a time- and effort-saving tool in this work.

Evening classes are available nearby at the University of California, Los Angeles, and the University of Southern California, for engineering writers desiring to advance their knowledge of the electronics arts.

FOR INFORMATION CONCERNING AVAILABLE POSITIONS WRITE:

Scientific
Staff
Relations

HUGHES

RESEARCH AND DEVELOPMENT LABORATORIES

Culver City, Los Angeles County, California

Photo, above: Engineering writer working with Hughes engineers on a design phase of the Hughes Falcon air-to-air guided missile.

snipped off the leads of the old capacitor and had soldered the new one in place. He slid the set back into its cabinet and turned it on. In a few minutes it was humming just as loudly as before.

"You tricked me! You put that thing in wrong on purpose!" Elmer shrieked.

"Now, Elmer, stop that screeching and listen to me," Mac said sternly. "I never cheated a customer in my life, and I'm not starting with you, although you surely have got it coming. I tried to tell you I didn't think the original capacitor was bad, but you wouldn't listen. Now you stand there without opening your yap while I find out what is wrong with this set. So help me, if I hear another word out of you, I'll double your bill."

Under this dire threat, Elmer kept silent; but it was only by means of a very visible effort. Mac slid the chassis out of the cabinet again and used the rubber tube puller to remove the hot 50C5 tube. From the tube stock a new tube was obtained and placed in the socket. The set was turned on and once more slid into the cabinet so that the baffle would accentuate any low-frequency hum that might be present. After several minutes, it remained hum-free, even when Elmer placed a suspicious ear right against the speaker opening.

"You satisfied that's the trouble?" Mac demanded of Elmer, who still was keeping his lips tightly sealed.

"I reckon I am," Elmer said grudgingly; "but just wait 'til I get hold of that know-it-all nephew of mine. He charged me a whole two dollars for that distributor I didn't need. A fine radio man he is!"

"Don't be too hard on him," Mac said. "He's probably plenty smart about radio equipment used in the Navy. I know the training those boys get is first class. This case, though, could trip up almost anyone not experienced in radio receiver servicing. The clue was the fact the hum was not there at first but came on fairly gradually. Open filter capacitors seldom act like that. This case was caused by a cathode-to-heater leakage that increased as the output tube warmed up. Only experience, of which you think so little, let me suspect this."

"Well," Elmer snarled, "what do I owe you?"

Mac thought a little and then said, "Elmer, I'm just going to charge you for the tube and my regular minimum charge for a service job that would not normally require removing the chassis. You do not deserve this break, but I hope the experience has taught you a lesson. The next time, have faith in me or take your work to someone you do trust. Here's your bill. Pay Miss Perkins out front."

Elmer snatched the bill from Mac's hand, looked at it, and then started for the door. As he reached it, though, he stopped and turned around. He swallowed hard a couple of times and then blurted out, "I've been an old

(Continued on page 161)

Heathkits

FOR THE ENTIRE ELECTRONICS INDUSTRY

more than 65 top-quality models to choose from, including such outstanding kit designs as



V-7A VACUUM TUBE VOLTMETER: Easily the world's largest selling VTVM. Features peak-to-peak scales—etched metal circuit board—1% precision resistors—full wave rectifier and AC input circuit—reads rms and peak-to-peak AC, DC, and ohms.

O-10 LABORATORY TYPE OSCILLOSCOPE: The world's largest selling oscilloscope kit, and the most successful oscilloscope in history. Designed especially for color and black-and-white TV service work. Its 5 megacycle bandwidth and new 500 Kc sweep generator readily qualify it for laboratory applications. Features easy-to-assemble etched metal circuit board construction.

WA-P2 HIGH FIDELITY PREAMPLIFIER: This is the world's largest selling hi fi preamplifier kit. Features complete equalization, 5 separate switch-selected inputs with individual pre-set level controls, beautiful modern appearance, high-quality components.

HIGH FIDELITY AMPLIFIERS: Five Heathkit Models to choose from at prices ranging from \$16.95 to \$59.75. Power output range from 7 to 25 watts.

DX-100 TRANSMITTER: A 100 watt phone and CW ham transmitter, offering the greatest dollar value available in the ham radio field today.

Greatest Dollar Value Through Factory-To-You Selling!

ONLY Heathkits CAN GIVE YOU ALL OF THESE DISTINCTIVE ADVANTAGES!

- ▶ *The Most Complete Construction Manuals for Easy Assembly.*
- ▶ *Originality of Design—Developed Through Pioneering in the Kit Instrument Field.*
- ▶ *Greatest Dollar Value—Finest Quality with Real Economy.*
- ▶ *Direct Contact with Manufacturer—Lower Price, Guaranteed Performance.*
- ▶ *Etched Metal, Prewired Circuit Boards—Save Construction Time, Improve Performance.*
- ▶ *High Quality Standard Components for Long-Life Service.*

HEATH COMPANY

A Subsidiary of Daystrom, Inc.

BENTON HARBOR 15, MICHIGAN

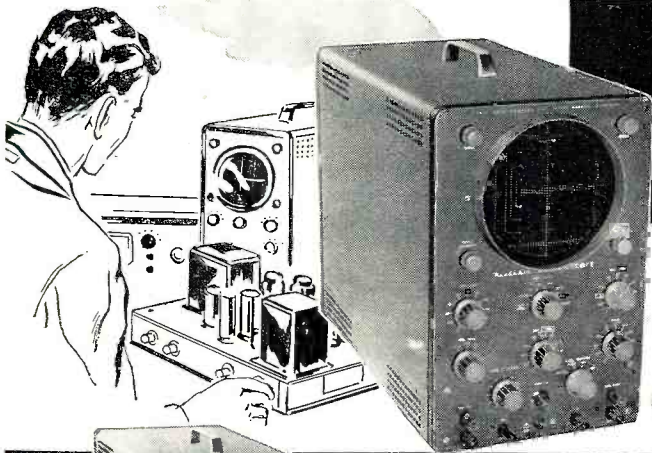

there is no substitute for
HEATHKIT QUALITY

YOU GET MORE: All first-run, top quality parts—the latest in electronic design—complete and comprehensive step-by-step assembly instructions with large pictorial diagrams and assembly drawings. Proven performance through the production of thousands of kits.

MODEL O-10

1



2

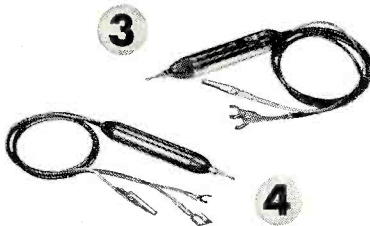

3

4

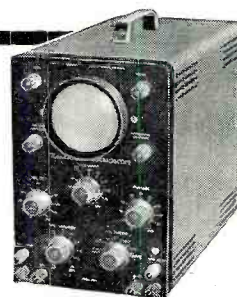

5

1 *Heathkit* ETCHED CIRCUIT
COLOR-TV
5" OSCILLOSCOPE KIT

This deluxe quality oscilloscope has proven itself through thousands of operating hours in service shops and laboratories. Features the best in components—and the best in circuit design.

Features amplifier response to 5 Mc for color TV work, and employs the radically new sweep circuit to provide stable operation up to 500,000 cps. In addition, etched metal, pre-wired circuit boards cut assembly time almost in half, and permit a level of circuit stability never before achieved in an oscilloscope of this type.

Vertical amplifiers flat within ± 2 db -5 db from 2 cps to 5 Mc, down only $1\frac{1}{2}$ db at 3.58 Mc. Vertical sensitivity is 0.025 volts, (rms) per inch at 1 Kc. 11 tube circuit employs a 5U1 CRT.

Plastic molded capacitors used for coupling and bypass—preformed and cabled wiring harness provided.

Features built-in peak-to-peak calibrating source—retrace blanking amplifier—push-pull amplifiers and step-attenuated input.

MODEL O-10
\$6950
Shpg. Wt. 21 lbs.

3 *Heathkit* LOW CAPACITY
PROBE KIT

Scope investigation of circuits encountered in TV requires the use of special low capacity probe to prevent loss of gain, circuit loading, or distortion. This probe features a variable capacitor to provide correct instrument impedance matching. Also the ratio of attenuation can be controlled.

NO. 342
\$350
Shpg. Wt. 1 lb.

4 *Heathkit* ETCHED CIRCUIT
SCOPE DEMODULATOR PROBE KIT

Extend the usefulness of your Oscilloscope by observing modulation envelope of R.F. or I.F. carriers found in TV and radio receivers. Functions like AM detector to pass only modulation of signal and not signal itself. Applied voltage limits are 30 V. RMS and 500 V. DC.

NO. 337-C
\$350
Shpg. Wt. 1 lb.

2 *Heathkit* ETCHED CIRCUIT
5" OSCILLOSCOPE KIT

This is a general purpose oscilloscope for the more usual applications in the service shop or lab, yet is comparable to scopes costing many dollars more.

Features full size 5" CRT (5BP1), built-in peak-to-peak voltage calibration—3 step input attenuator—phasing control—push-pull deflection amplifiers—and etched metal pre-wired circuit boards.

Vertical channel flat within ± 3 db from 2 cps to 200 Kc, with 0.09 V. rms/inch, peak-to-peak sensitivity at 1 Kc. Sweep circuit from 20 cps to 100,000 cps. A scope you will be proud to own and use.

MODEL OM-1
\$4950
Shpg. Wt. 21 lbs.

5 *Heathkit* ETCHED CIRCUIT
3" OSCILLOSCOPE KIT

This compact little oscilloscope measures only $9\frac{1}{2}$ " H. x $6\frac{1}{2}$ " W. x $11\frac{3}{4}$ " D., and weighs only 11 lbs! Easily employed for home service calls, for work in the field or is just the ticket for use in the ham shack or home workshop. Incorporates many of the features of the Model OM-1, but yet is smaller in physical size for portability.

Employing etched circuit boards, the Model OL-1 features vertical response within ± 3 db from 2 cps to 200 Kc. Vertical sensitivity is 0.25 V. RMS/inch peak-to-peak, and sweep generator operates from 20 cps to 100,000 cps. Provision for r.f. connection to deflection plates for modulation monitoring, and incorporates many features not expected at this price level. 8-tube circuit features a type 3GP1 Cathode Ray Tube.

MODEL OL-1
\$2950
Shpg. Wt. 14 lbs.

HEATH COMPANY

A Subsidiary
of Daystrom, Inc.

BENTON HARBOR 15, MICHIGAN

fill your test requirements WITH HEATHKITS

DESIGNED FOR YOU: *Heath Company test equipment is designed for the maximum in convenience. Besides being functional, Heathkits represent the very latest in modern physical appearance, and incorporate all the latest circuit design features for comprehensive test coverage.*

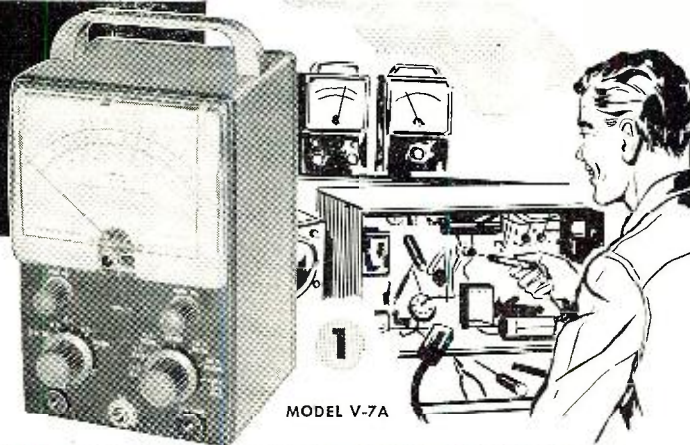

MODEL V-7A



2



3

4

5

6



1

Heathkit ETCHED CIRCUIT

VACUUM TUBE VOLTMETER KIT

Besides measuring AC (rms), DC and resistance, the modern-design V-7A incorporates peak-to-peak measurement for FM and television servicing.

AC (rms) and DC voltage ranges are 1.5, 5, 15, 50, 150, 500, and 1500. Peak-to-peak AC voltage ranges are 4, 14, 40, 140, 400, 1400, and 4000. Ohmmeter ranges are X1, X10, X100, X1000, X10K, X100K, and X1 megohm. Also a db scale is provided. A polarity reversing switch provided for DC measurements, and zero center operation within range of front panel controls. Employs a 200 μ a meter for indication. Input impedance is 11 megohms.

Etched metal, pre-wired circuit board for fast, easy assembly and reliable operation is 50% thicker for more rugged physical construction. 1% precision resistors for utmost accuracy.

MODEL V-7A

\$2450

Shpg. Wt. 7 Lbs.

2

Heathkit 20,000 OHMS/VOLT

MULTIMETER KIT

The MM-1 is a portable instrument for outside servicing, for field testing, or for quick portability in the service shop. Combines attractive physical appearance with functional design. 20,000 ohms/v. DC, and 5000 ohms/v. AC. AC and DC voltage ranges are 0-1.5, 5, 50, 150, 500, 1500 and 5000 volts. Direct current ranges are 0-150 μ a., 15 ma., 150 ma., 500 ma., and 15 amperes. Resistance ranges are X1, X100, X10,000 providing center scale readings of 15, 1500 and 150,000 ohms. DB ranges cover -10 db to +65 db.

Features a 4½" 50 μ a. meter. Provides polarity reversal on DC measurements. 1% precision resistors used in multiplier circuits. Not affected by RF fields.

MODEL MM-1

\$2950

Shpg. Wt. 6 Lbs.

3

Heathkit ETCHED CIRCUIT

RF PROBE KIT

The Heathkit RF Probe used in conjunction with any 11 megohm VTVM will permit RF measurements up to 250 Mc with \pm 10% accuracy. Uses etched circuits for increased circuit stability and ease of assembly.

NO. 309-C

\$350

Shpg. Wt. 1 Lb.

4

Heathkit ETCHED CIRCUIT

PEAK-TO-PEAK PROBE KIT

Now read peak-to-peak voltages on the DC scale of any 11 megohm VTVM with this new probe, employing etched circuit for stability and low loss. Readings made directly from VTVM scales, from 5 Kc to 5 Mc. Not required for Heathkit Model V-7A VTVM.

NO. 338-C

\$550

Shpg. Wt. 2 Lbs.

5

Heathkit 30,000 VOLT D.C.

HIGH VOLTAGE PROBE KIT

For TV service work or similar application for measurement of high DC voltage. Precision multiplier resistor mounted inside plastic probe. Multiplication factor of 100 on the ranges of Heathkit 11 megohm VTVM.

NO. 336

\$450

Shpg. Wt. 2 Lbs.

6

Heathkit

HANDITESTER KIT

The Model M-1 measures AC or DC voltage at 0-10, 30, 300, 1000, and 5000 volts. Measures direct current at 0-10 ma. and 0-100 ma. Provides ohmmeter ranges of 0-3000 (30 ohm center scale) and 0-300,000 ohms (3000 ohms center scale). Features a 400 μ a. meter for sensitivity of 1000 ohms/volt. Because of its size, the M-1 is a very handy portable instrument that will fit in your coat pocket, tool box, glove compartment, or desk drawer. Makes a fine standby unit in the service shop when the main instruments are in use, or is ideal for the hobbyist or beginner. An unusual dollar value.

MODEL M-1

\$1450

Shpg. Wt. 3 Lbs.

HEATH COMPANY

A Subsidiary
of Daystrom, Inc.

BENTON HARBOR 15, MICHIGAN

Heathkit
TV ALIGNMENT
**GENERATOR
KIT**



1

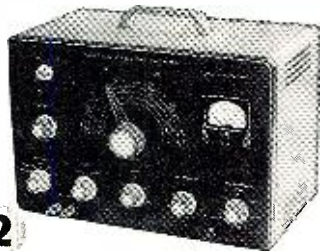

2



3

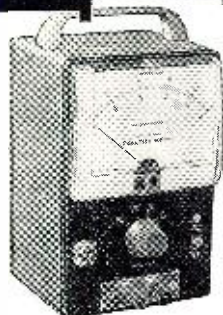

4

**HEATH
COMPANY**
A SUBSIDIARY OF DAYSTROM INC.

The Model TS-4 features a controllable inductor for all-electronic sweep, improved oscillator and automatic gain circuitry, high RF output, center sweep operation, and improved linearity. It sets a new high standard for sweep generator operation, and is absolutely essential for the up-to-date service shop doing FM, black-and-white TV, and color TV work.

Voltage regulation and effective AGC action insure flat output over a wide frequency range. Electronic sweep insures complete absence of mechanical vibration. Sweep deviation controllable from 0 up to 40 Mc, depending upon base frequency. Effective two-way blanking.

Fundamental output from 3.6 Mc to 220 Mc in 4 bands. Crystal marker provides markers at 4.5 Mc and multiples thereof. Crystal included with kit. Variable marker covers from 19 Mc to 60 Mc on fundamentals, and up to 180 Mc on harmonics. Provision for external marker.



MODEL TS-4
\$49.50
Shpg. Wt. 16 Lbs.

1

Heathkit LINEARITY PATTERN
GENERATOR KIT

The new-design Model LP-1 produces vertical or horizontal bar patterns, a cross-hatch pattern, or white dots on the screen of the TV set under test. No internal connections required. Special clip is attached to the TV antenna terminals. Instant selection of the pattern desired for adjustment of vertical and horizontal linearity, picture size, aspect ratio, and focus. Dot pattern presentation is a *must* for color convergence adjustments on color TV sets.

Extended operating range covers all television channels from 2 to 13. Produces 6 to 12 vertical bars or 4 to 7 horizontal bars.

MODEL LP-1
\$22.50
Shpg. Wt. 7 Lbs.

2

Heathkit LABORATORY
GENERATOR KIT

The Heathkit Model LG-1 Laboratory Generator is a high-accuracy signal source for applications where metered performance is essential. It covers from 100 Kc to 30 Mc on fundamentals in 5 bands. Modulation is at 400 cycles, and modulation is variable from 0-50%. RF output from 100,000 μ v. to 1 μ v. 200 μ a. meter reads the RF output in microvolts, or percentage of modulation. Fixed step and variable output attenuation provided.

Features voltage regulation, and double copper plated shielding for stability. Provision for external modulation. Coaxial output cable (50 ohms).

MODEL LG-1
\$39.50
Shpg. Wt. 16 Lbs.

3

Heathkit CATHODE RAY
TUBE CHECKER KIT

This new-design instrument holds the key to rapid and complete picture tube testing, either in the set, on the work-bench, or in the carton. Tests for shorts, leakage, and emission. Features Shadow-graph test (a spot of light on the screen) to indicate whether the tube is capable of functioning.

The Model CC-1 tests all electromagnetic deflection picture tubes normally encountered in television servicing. Supplies all operating voltages to the tube under test, and indicates the condition of the tube on a large "GOOD-BAD" scale. Features spring loaded test switches for operator protection.

The CC-1 is housed in an attractive portable case and is light in weight — ideal for outside service calls.

MODEL CC-1
\$22.50
Shpg. Wt. 10 Lbs.

4

Heathkit DIRECT READING
CAPACITY METER KIT

Not only is this instrument popular in the service shop, but it has found extensive application in industrial situations. Ideal for quality control work, production line checking, or for matching pairs.

Features direct reading linear scales from 100 mmf to .1 mfd full scale. Necessary only to connect a capacitor of unknown value to the insulated binding posts, select the correct range, and read the meter. The CM-1 is not susceptible to hand capacity, and has a residual capacity of less than 1 mmf.

MODEL CM-1
\$29.50
Shpg. Wt. 7 Lbs.

BENTON HARBOR 15, MICHIGAN
RADIO & TELEVISION NEWS

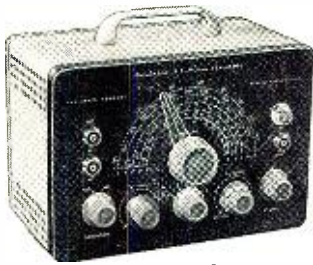

MODEL SG-8 **\$1950**
Shpg. Wt. 8 Lbs.

low price deceive you. This is a professional type service instrument to fulfill the signal source requirements in the service lab.

This is one of the biggest signal generator bargains available today. The tried and proven Model SG-8 offers all of the outstanding features required for a basic service instrument. High quality components and outstanding performance.

The SG-8 covers 160 Kc to 110 Mc on fundamentals in 5 bands, and calibrated harmonics extend its usefulness up to 220 Mc. The output signal is modulated at 400 cps, and the RF output is in excess of 100,000 uv. Output controlled by both a continuously variable and a fixed step attenuator. Also, audio output may be obtained for amplifier testing. Don't let the

Heathkit SIGNAL GENERATOR KIT

1 Heathkit . . . IMPEDANCE BRIDGE KIT

The IB-2 features built-in adjustable phase shift oscillator and amplifier, and has panel provisions for external generator. Measures resistance, capacitance, inductance, dissipation factors of condensers, and storage factor of inductance.

D, Q, and DQ functions combined in one control. 1/2% resistors and 1/2% silver-mica capacitors especially selected for this instrument. A 100-0-100 microammeter provides null indications. Two-section CRL dial provides 10 separate "units" with an accuracy of .5%. Fractions of units read on variable control.

MODEL IB-2
\$5950
Shpg. Wt. 12 Lbs.

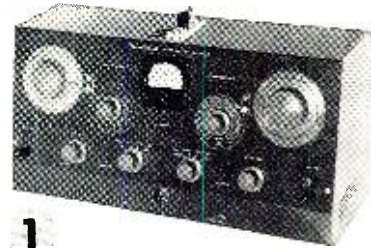

2 Heathkit "Q" METER KIT

The Heathkit Model QM-1 will measure the Q of inductances and the RF resistance and distributed capacity of coils. Employs a 4 1/2" 50 microampere meter for direct indication. Will test at frequencies of 150 Kc to 18 Mc in 4 ranges. Measures capacity from 40 mmf to 450 mmf within ± 3 mmf. Indispensable for coil winding and determining unknown condenser values. A worthwhile addition to your laboratory at an outstandingly low price. Useful for checking wave traps, chokes, peaking coils, etc. Laboratory facilities are now available to the service shop and home lab.

MODEL QM-1
\$4450
Shpg. Wt. 14 Lbs.

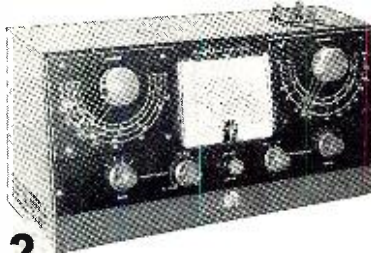

3 Heathkit 6-12 VOLT BATTERY ELIMINATOR KIT

This modern battery eliminator will supply 6 or 12 volt output for ordinary automobile radios as well as 12 volts for the new models in the latest model cars. Output voltage is variable from 0-8 volts DC, or 0-16 volts DC. Will deliver up to 15 amperes at 6 volts, or up to 7 amperes at 12 volts. Two 10,000 microfarad filter capacitors insure smooth DC output. Two panel meters monitor output voltage and current. Will double as a battery charger. Definitely required for automobile radio service work.

MODEL BE-4
\$3150
Shpg. Wt. 17 Lbs.

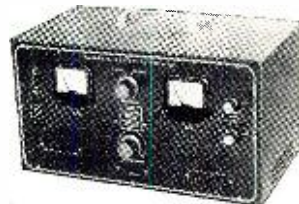

4 Heathkit DECADE RESISTANCE KIT

Twenty 1% precision resistors provide resistance from 1 to 99,999 ohms in 1 ohm steps. Indispensable around service shop laboratory, ham shack, or home workshop. Well worth the extremely low Heathkit price.

MODEL DR-1
\$1950
Shpg. Wt. 4 Lbs.

3

5 Heathkit VIBRATOR TESTER KIT

Tests vibrators for proper starting and indicates the quality of the output on a large "GOOD-BAD" scale. Checks both interrupter and self-rectifier types in 5 different sockets. Operates from any battery eliminator delivering variable voltage from 4 to 6 volts DC at 4 amps. Ideal companion to the Model BE-4.

MODEL VT-1
\$1450
Shpg. Wt. 6 Lbs.

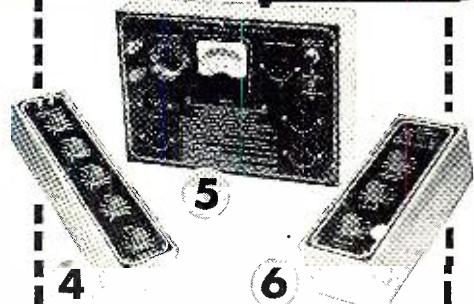

5

6 Heathkit DECADE CONDENSER KIT

Provides capacity values from 100 mmf to 0.111 mfd in steps of 100 mmf. ± 1% precision silver-mica condensers used. High quality ceramic switches for reduced leakage. Polished birch cabinet. Extremely valuable in all electronic activity.

MODEL DC-1
\$1650
Shpg. Wt. 3 Lbs.

4

6

HEATH COMPANY

A SUBSIDIARY OF DAYSTROM INC.

BENTON HARBOR 15, MICHIGAN

Heathkit TUBE CHECKER KIT

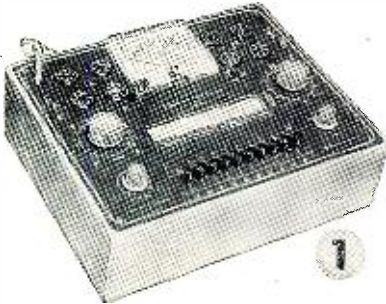

1 The Heathkit Model TC-2 is an emission type tube tester that represents a tremendous saving over the price of a comparable unit from any other source. At only \$29.50, you can have a tube tester of your own, even if you are an experimenter, or only do part time service work. Extremely popular with radio servicemen, it uses a 4½" meter with 3-color meter face for simple "GOOD-BAD" indications that the customer can understand. Will test all tubes commonly encountered in radio and TV service work.

Ten 3-position lever switches for "open" or "short" tests on each tube element. Neon bulb indicates filament continuity or short between tube elements. Line adjust control provided. The roll chart is illuminated.

Sockets provided for 4, 5, 6, and 7-pin, octal, and loctal tubes, 7 and 9 pin miniature tubes, and the 5 pin Hytron tubes. Blank space provided for future socket addition. Tests tubes for opens, and shorts, and for quality on the basis of total emission. 14 different filament voltage values provided.

MODEL TC-2
\$29.50
Shpg. Wt. 12 Lbs.

2 Heathkit PORTABLE TUBE CHECKER KIT

The Model TC-2P is identical to the Model TC-2 except that it is housed in a rugged carrying case. This strikingly attractive and practical two-tone case is finished in proxylin impregnated fabric. The cover is detachable, and the hardware is brass plated. This case imparts a real professional appearance to the instrument. Ideal for home service calls, or any portable application.

MODEL TC-2P
\$34.50
Shpg. Wt. 15 Lbs.



3 Heathkit TV PICTURE TUBE TEST ADAPTER

The Heathkit TV picture tube test adapter is designed for use with the Model TC-2 Tube Checker. Test picture tubes for emission, shorts, and thereby determine tube quality. Consists of 12-pin TV tube socket, 4 ft. cable, octal connector, and necessary technical data. (Not a kit.)

MODEL 355
\$45.00
Shpg. Wt. 1 Lb.

4 Heathkit . . . CONDENSER CHECKER KIT

Use this Condenser Checker to quickly and accurately measure those unknown condenser and resistor values. All readings taken directly from the calibrated panel scales without any involved calculation. Capacity measurements in four ranges from .00001 to 1000 mfd. Checks paper, mica, ceramic and electrolytic condensers. A power factor control is available for accurate indication of electrolytic condenser efficiency. Leakage test switch—selection of five polarizing voltages, 25 volts to 450 volts DC to indicate condenser operating quality under actual load conditions. Spring-return test switch automatically discharges condenser under test and eliminates shock hazard to the operator.

Resistance measurements can be made in the range from 100 ohms to 5 meg-ohms. Here again, all values are read directly on the calibrated scales. Increased sensitivity coupled with an electron beam null indicator increases overall instrument usefulness.

For safety of operation, the circuit is entirely transformer operated. An outstanding low kit price for this surprisingly accurate instrument.

MODEL C-3
\$19.50
Shpg. Wt. 7 Lbs.

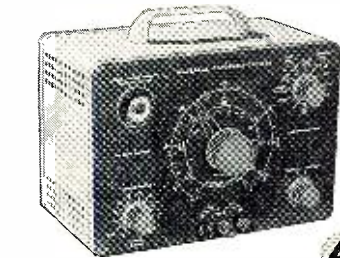

5 Heathkit VISUAL-AURAL SIGNAL TRACER KIT

This signal tracer is extremely valuable in servicing AM, FM, and TV receivers, especially when it comes to isolating trouble to a particular stage of the circuit under test.

This visual-aural tracer features a high gain RF input channel to permit signal tracing from the receiver antenna input clear through all RF, IF, detector, and audio stages to the speaker. Separate low-gain channel provided for audio circuit exploration. Both visual and aural indication by means of a speaker or headphone, and electron beam "eye" tube as a level indicator. Also incorporates a noise locator circuit for DC noise checks, and a built-in calibrated wattmeter (30-500 watts). Panel terminals provided for "patching" output transformer or speaker into external circuit for test purposes. Designed especially for the radio and TV serviceman. Cabinet size: 9½" wide x 6½" high x 5" deep. A real test equipment bargain.

MODEL T-3
\$23.50
Shpg. Wt. 9 Lbs.



**HEATH
COMPANY**

A SUBSIDIARY OF DAYSTROM INC.

BENTON HARBOR 15, MICHIGAN

RADIO & TELEVISION NEWS



MODEL HD-1

Shpg. Wt. 13 Lbs. **\$4950**

Used with a sine wave generator, the Model HD-1 will check the harmonic distortion output of audio amplifiers under a variety of conditions. Reads distortion directly on the meter as a percentage of the input signal. Operates between 20 and 20,000 cps. High impedance VTVM circuit for initial reference settings and final distortion readings. Ranges are 0-1, 3, 10, and 30 volts full scale. 1% precision resistors. Distortion scales are 0-1, 3, 10, 30 and 100% full scale. Requires only .3 volt input for distortion test.

Heathkit HARMONIC DISTORTION METER KIT



MODEL AA-1
\$5950

Shpg. Wt. 13 Lbs.

1 Heathkit AUDIO ANALYZER KIT

This instrument consists of an audio wattmeter, an AC VTVM, and a complete IM analyzer, all in one compact unit.

Use the VTVM to measure noise, frequency response, output gain, power supply ripple, etc. Use the wattmeter for measurement of power output. Internal loads provided for 4, 8, 16, or 600 ohms. VTVM also calibrated for DBM units. High or low impedance IM measurements made with built-in 6KC and 60 cps generators. VTVM ranges are .01, to 300 volts in 10 steps. Wattmeter ranges are .15 mw. to 150 w. in 7 steps. IM scales are 1% to 100% in 5 steps.

2 Heathkit AUDIO GENERATOR KIT

This new Heathkit Model features step-tuning from 10 cps to 100 Kc with three rotary switches that provide two significant figures and multiplier. Less than .1% distortion. Frequency accurate to within $\pm 5\%$.

Output monitored on a large 4 1/2" meter that reads voltage or db. Both variable and step-type attenuation provided. Meter reads zero-to-maximum at each attenuator position. Output ranges (and therefore meter ranges) are 0-.003, .01, .03, .1, .3, 1, 3, 10 volts. Step-tuning provides rapid positive selection of the desired frequency, and allows accurate return to any given frequency.

MODEL AG-9
\$3450

Shpg. Wt. 8 Lbs.



3 Heathkit AUDIO OSCILLATOR KIT

(SINE WAVE — SQUARE WAVE)

The Model AO-1 features sine wave or square wave coverage from 20-20,000 cps in 3 ranges. It is an instrument specifically designed to completely fulfill the needs of the serviceman and high fidelity enthusiast. Offers high level output across the entire frequency range, low distortion and low impedance output. Features a thermistor in the second amplifier stage to maintain essentially flat output through the entire frequency range. Produces an excellent sine wave for audio testing, or will produce good, clean, square waves with a rise time of only 2 microseconds.

MODEL AO-1
\$2450

Shpg. Wt. 10 Lbs.



4 Heathkit RESISTANCE SUBSTITUTION BOX KIT...

Provides switch selection of 36 RTMA 1 watt standard 1% resistors ranging from 15 ohms to 10 megohms. Numerous applications in radio and TV work, and essential in the developmental laboratory.

MODEL RS-1
\$550

Shpg. Wt. 2 Lbs.

5 Heathkit AC VACUUM TUBE VOLTMETER KIT...

The Heathkit AC VTVM features high impedance, wide frequency range, very high sensitivity, and extremely wide voltage range. Will accurately measure a voltage as small as 1 mv. at high impedance. Excellent for sensitive AC measurements required by laboratories, audio enthusiasts and experimenters. Frequency response is substantially flat from 10 cps to 50 Kc. Ranges are .01, .03, .1, .3, 1, 3, 10, 30, 100, and 300 v. RMS. Total db range -52 to + 52 db. Input impedance 1 megohm at 1 Kc.

MODEL AV-2
\$2950

Shpg. Wt. 5 Lbs.

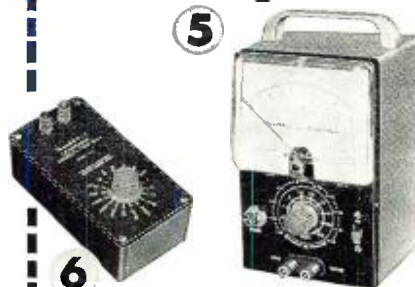

6 Heathkit CONDENSER SUBSTITUTION BOX KIT...

Very popular companion to Heathkit RS-1. Individual selection of 18 RTMA standard condenser values from .0001 mfd to .22 mfd. Includes 18" flexible leads with alligator clips.

MODEL CS-1
\$550

Shpg. Wt. 2 Lbs.



HEATH COMPANY

A SUBSIDIARY OF DAYSTROM INC.

BENTON HARBOR 15, MICHIGAN



HEATHKIT HAM GEAR

for high quality at moderate cost

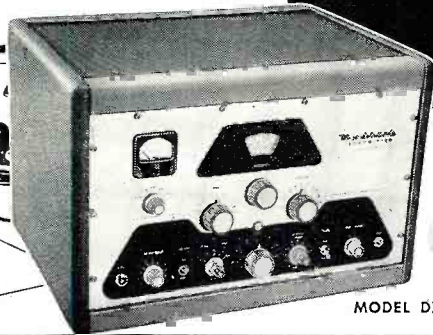

MODEL DX-100

DOLLAR VALUE: You get more for your Heathkit dollar because your labor is used to build the kit instead of paying for someone else's. Also, the middleman's margin of profit is eliminated when you deal directly with the manufacturer.

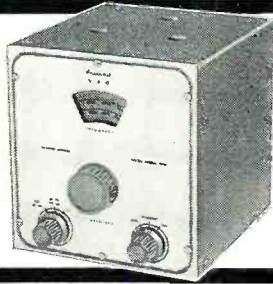

2

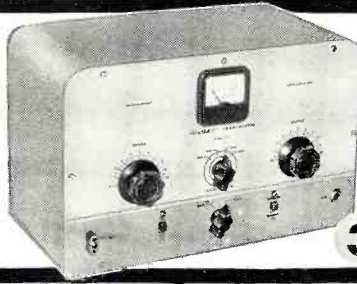

3



4

1 Heathkit DX-100 PHONE & CW TRANSMITTER KIT

The reception given this amateur transmitter has been tremendous. Reports from radio amateurs using the DX-100 are enthusiastic in praising its performance and the high quality of the components used in its assembly. Actual "on the air" results reflect the careful design that went into its development.

The DX-100 features a built-in VFO, modulator, and power supplies, and is completely bandswitching for phone or CW operation on 160, 80, 40, 20, 15, 11, and 10 meters. All parts necessary for construction are supplied in the kit, including tubes, cabinet, and detailed step-by-step instructions. Easy to build, and a genuine pleasure to operate.

Employs push-pull 1625's modulating parallel 6146's for RF output in excess of 100 watts on phone and 120 watts on CW. May be excited from the built-in VFO or from crystals (crystals not included with kit). Features five-point TVI suppression: (1) pi network interstage coupling to reduce harmonic transfer to the final stage; (2) pi network output coupling; (3) extensive shielding; (4) all incoming and outgoing circuits filtered; (5) inter-locking cabinet seams to eliminate radiation except through the coaxial output connector. Pi network output coupling will match 50 to 600 ohm non-reactive load. Illuminated VFO dial and meter face. Remote control socket provided.

The chassis is made of extra-strong #16 gauge copper-plated steel. It employs potted transformers, ceramic switch and variable capacitor insulation, solid silver loading switch terminals, and high-grade well-rated components throughout. Features a pre-formed wiring harness, and all coils are pre-wound.

High-gain speech amplifier for dynamic or crystal microphones, and restricted speech range for increased intelligence. Plenty of audio power reserve. Measures 20 7/8" W. x 13 3/4" H. x 16" D. Schematic diagram and complete technical specifications on request.

MODEL DX-100

\$189⁵⁰

Shpg. Wt. 120 Lbs.

Shipped Motor Freight Unless Otherwise Specified
\$50.00 Deposit Required on C.O.D. Orders

2 Heathkit VFO KIT

The Model VF-1 covers 160-80-40-20-15-11 and 10 meters with three basic oscillator frequencies. Better than 10-volt average RF output on fundamentals. Features illuminated and pre-calibrated dial scale. Cable and plug provided to fit crystal socket of any modern transmitter.

Enjoy the convenience and flexibility of VFO operation at no more than the price of crystals. May be powered from plug on the Heathkit Model AT-1 transmitter, or supplied with power from most transmitters. Measures: 7" H. x 6 1/2" W. x 7" D.

MODEL VF-1

\$19⁵⁰

Shpg. Wt. 7 Lbs.

3 Heathkit CW AMATEUR TRANSMITTER KIT

The Model AT-1 is an ideal novice transmitter, and may be used to excite a higher power rig later on.

This CW transmitter is complete with its own power supply, and covers 80, 40, 20, 15, 11, and 10 meters. Features single-knob bandswitching, and panel meter indicates grid or plate current for the final amplifier. Designed for crystal operation or external VFO. Crystal not included in kit. Incorporates such features as key click filter, line filter, copper-plated chassis, pre-wound coils, 52 ohm coaxial output, and high quality components throughout. Instruction book simplifies assembly. Employs a 6AG7 oscillator, 6L6 final amplifier. Operates up to 35 watts plate power input.

MODEL AT-1

\$29⁵⁰

Shpg. Wt. 15 Lbs.

4 Heathkit ... ANTENNA COUPLER KIT

The Model AC-1 will properly match your low power transmitter to an end-fed long wire antenna. Also attenuates signals above 36 Mc, reducing TVI. 52 ohm coax. input → power up to 75 watts—10 through 80 meters—tapped inductor and variable condenser—neon RF indicator—copper plated chassis and high quality components. Ideal for use with Heathkit AT-1 Transmitter.

MODEL AC-1

\$14⁵⁰

Shpg. Wt. 4 Lbs.

HEATH COMPANY

A Subsidiary
of Daystrom, Inc.

BENTON HARBOR 15, MICHIGAN

"AMATEUR-ENGINEERED"

Equipment For The Ham

MODERN DESIGN: You can be sure of getting all the latest and most desirable design features when you buy Heathkits. Advanced-design is a minimum standard for new Heathkit models.

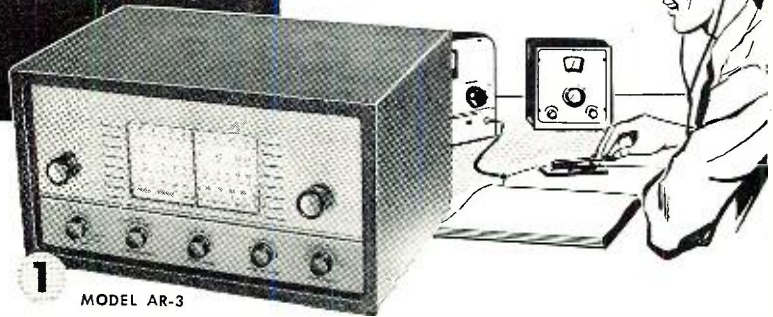

1 MODEL AR-3

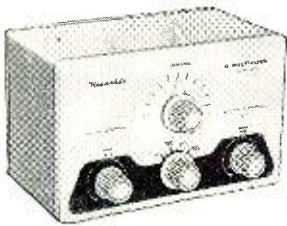

2



3



4



5

1 Heathkit COMMUNICATIONS-TYPE ALL BAND RECEIVER KIT

The new Model AR-3 features improved IF and RF performance, along with better image rejection on all bands. Completely new chassis layout for easier assembly, even for the beginner.

Covers 550 Kc to 30 Mc in four bands. Provides sharp tuning and good sensitivity over the entire range. Features a transformer-type power supply—electrical bandspread—separate RF and AF gain controls—antenna trimmer—noise limiter—AGC—BFO—headphone jacks—5½" PM speaker and illuminated tuning dial.

CABINET: Fabric covered cabinet with aluminum panel as shown. Part No. 91—shipping weight 5 lbs. \$4.50.

MODEL AR-3

\$27⁹⁵

Shpg. Wt. 12 Lbs.
(Less Cabinet)

2 Heathkit "Q" MULTIPLIER KIT

Here is the Heathkit Q Multiplier you hams have been asking for. A tremendous help on the phone and CW bands when the QRM is heavy. Provides an effective Q of approximately 4,000 for extremely sharp "peak" or "null." Use it to "peak" the desired signal or to "null" an undesired signal, or heterodyne. Tunes to any signal within the IF band-pass of your receiver. Also provides "broad peak" for conditions where extreme selectivity is not required.

Operates with any receiver having an IF frequency between 450 and 460 Kc. Will not function with AC-DC type receivers. Requires 6.3 volts AC at 300 ma. and 150 to 250 VDC at 2 ma. Derives operating power from your receiver. Uses a 12AX7 tube, and special High-Q shielded coils. Simple to connect with the cable and plugs supplied. Measures only 4-11/16"H.x7¾"W.x4½"D. A really valuable addition to the receiving equipment in your ham shack.

MODEL QF-1

\$9⁹⁵

Shpg. Wt. 3 Lbs.

3 Heathkit VARIABLE VOLTAGE REGULATED POWER SUPPLY KIT

Provides well filtered DC output, variable from zero to 500 volts at no load and *regulated* for stability. Will supply up to 10 ma. at 450 VDC, and up to 130 ma. at 200 VDC. Voltage or current monitored on front panel meter. Also provides 6.3 VAC at 4A. for filament. Filament voltage isolated from B+, and both isolated from ground. Invaluable around the ham shack for supplying operating potentials to experimental circuits. Use in all types of research and development laboratories as a temporary power supply, and to determine design requirements for ultimate power supply.

MODEL PS-3

\$35⁵⁰

Shpg. Wt. 17 lbs.

4 Heathkit ANTENNA IMPEDANCE METER KIT

Use in conjunction with a signal source for measuring antenna impedance, line matching, adjustment of beam and mobile antennas, etc. Will double as a phone monitor or relative field strength indicator. 100 µa. meter employed. Covers the range from 0-600 ohms. An instrument of many uses for the amateur.

MODEL AM-1

\$14⁵⁰

Shpg. Wt. 2 lb.

5 Heathkit GRID DIP METER KIT

This is an extremely valuable tool for accomplishing literally hundreds of jobs on all types of equipment. Covering from 2 Mc to 250 Mc, the GD-1B is compact and can be operated with one hand. Uses a 500 µa. meter for indication, with a sensitivity control and headphone jack. Includes prewound coils and rack. Indispensable instrument for hams, engineers, or servicemen.

MODEL GD-1B

\$19⁵⁰

Shpg. Wt. 4 lbs.

HEATH COMPANY

A Subsidiary
of Daystrom, Inc.

BENTON HARBOR 15, MICHIGAN

Heathkits
 PROVIDE THE
 "CONSTRUCTIVE"
 APPROACH TO
 HIGH-FIDELITY

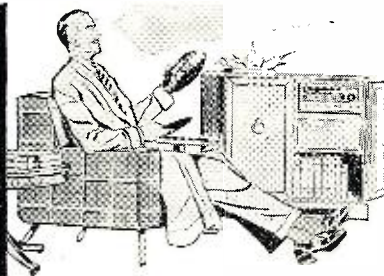

EASY TO BUILD: *The assembly instructions supplied with Heathkits are so complete and detailed that anyone can assemble the kits without difficulty. Plenty of pictorial diagrams and step-by-step instructions. Information on resistor color codes, soldering, use of tools, etc. Build-it-yourself with confidence!*

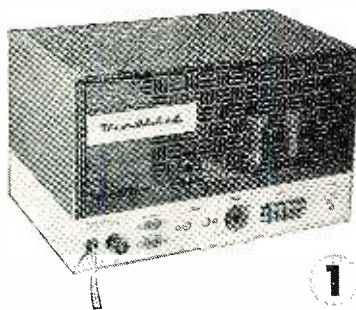

1 *Heathkit* **ADVANCED-DESIGN
 HIGH FIDELITY AMPLIFIER KIT**

The 25 Watt Model W-5 is one of the most outstanding high fidelity amplifiers available today—at any price. Incorporates the very latest design features to achieve true "presence" for the super-critical listener.

Features a new-design Peerless output transformer, and KT66 output tubes handle power peaks up to 42 watts. The unique "tweeter-saver" suppresses high frequency oscillation. A new type balancing circuit results in closer "dynamic" balance between output tubes. Features improved phase shift characteristics and frequency response, with reduced IM and harmonic distortion. Color styling harmonizes with the Heathkit WA-P2 Preamplifier and the FM-3 Tuner.

Frequency response—within ± 1 db from 5 cps to 160 Kc at 1 watt. Harmonic distortion only 1% at 25 watts, 20-20,000 cps. IM distortion only 1% at 20 watts, using 60 and 3,000 cps. Output impedance 4, 8, or 16 ohms. Hum and noise—99 db below rated output. Uses two 12AU7's, two KT66's and a 5R4GY.

KIT COMBINATIONS:

W-5M Amplifier Kit: Consists of main amplifier and power supply, all on one chassis. Complete with all necessary parts, tubes, and comprehensive manual. Shpg. Wt. 31 lbs. Express only.

\$59⁷⁵

W-5 Combination Amplifier Kit: Consists of W-5M Amplifier Kit listed above plus Heathkit Model WA-P2 Preamplifier Kit. Complete with all necessary parts, tubes, and construction manuals. Shpg. Wt. 38 lbs. Express only.

\$79⁵⁰



2 *Heathkit* **DUAL-CHASSIS WILLIAMSON TYPE
 HIGH FIDELITY AMPLIFIER KIT**

This is a very popular high fidelity amplifier kit that features dual-chassis type construction. The resulting physical dimensions offer an additional margin of flexibility in installation. It features the famous Acrosound TO-300 "ultra-linear" output transformer, and has a frequency response within ± 1 db from 6 cps to 150 Kc at 1 watt. Harmonic distortion only 1% at 21 watts. IM distortion at 20 watts only 1.3% at 60 and 3,000 cps. Rated power output is 20 watts. Output impedance 4, 8, or 16 ohms. Hum and noise—88 db below 20 watts. Uses two 6SN7's, two 5881's, and a 5V4G.

KIT COMBINATIONS:

W-3M: Consists of main amplifier and power supply for separate chassis construction. Includes all tubes and components necessary for assembly. Shpg. Wt. 29 lbs., Express only.

\$49⁷⁵

W-3: Consists of W-3M Kit listed above plus Heathkit Model WA-P2 Preamplifier described on opposite page. Shpg. Wt. 37 lbs., Express only.

\$69⁵⁰

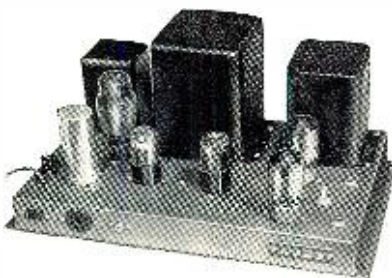

3 *Heathkit* **SINGLE-CHASSIS WILLIAMSON TYPE
 HIGH FIDELITY AMPLIFIER KIT**

This is the lowest priced Williamson type amplifier ever offered in kit form, and yet it retains all the usual features of the Williamson type circuit. Main amplifier and power supply combined on one chassis, and uses a new-design Chicago output transformer. Frequency response—within ± 1 db from 10 cps to 100 Kc at 1 watt. Harmonic distortion only 1.5% at 20 watts. IM distortion at rated output, 2.7% at 60 and 3,000 cps. Rated power output is 20 watts. Output impedance 4, 8, or 16 ohms. Hum and noise—95 db below 20 watts. Uses two 6SN7's, two 5881's, and one 5V4G.

Instructions are so complete that the kit may be assembled successfully even by a beginner in electronics.

KIT COMBINATIONS:

W-4AM: Consists of main amplifier and power supply for single chassis construction. Includes all tubes and components necessary for assembly. Shpg. Wt. 28 lbs. Express only.

\$39⁷⁵

W-4A: Consists of W-4AM Kit listed above plus Heathkit Model WA-P2 Preamplifier described on opposite page. Shpg. Wt. 35 lbs. Express only.

\$59⁵⁰

**HEATH
 COMPANY**

A SUBSIDIARY OF DAYSTROM INC.

BENTON HARBOR 15, MICHIGAN

RADIO & TELEVISION NEWS

ATTRACTIVELY STYLED: *Heathkit high fidelity instruments are not only functional, but are most attractive in physical design. Such units as the preamplifier and the W-5 main amplifier are designed for beauty as well as performance. They blend with any room decor and are the kind of instruments you will be proud to own.*



enjoy....
**THE VERY BEST
 IN AUDIO WITH
 "BUILD-IT-YOURSELF"
 HEATHKITS**

1 *Heathkit* HIGH FIDELITY
PREAMPLIFIER KIT

This outstanding preamplifier is designed specifically for use with the Heathkit Williamson type amplifiers. It completely fulfills the requirements for remote control, compensation and preamplification, and exceeds even the most rigorous specifications for high fidelity performance.

Features five separate switch-selected input channels (2 low level and 3 high level), each with its own input control. Full record equalization with four-position turnover control and four-position rolloff control.

Output jack for tape recorder — separate bass control with 18 db boost and 12 db cut at 50 cps. — treble control offering 15 db boost and 20 db cut at 15,000 cps — special hum control to insure minimum hum level — and many other desirable features. Overall frequency response (with controls set to "flat" position) is within 1 db from 25 cps to 30,000 cps. Will do justice to the finest available program sources. Beautiful satin-gold finish.

Power requirements from the Heathkit Williamson type high fidelity amplifier — 6.3 VAC at 1 amp., and 300 VDC at 10 Ma. Uses two 12AX7's and one 12AU7.

MODEL WA-P2
\$1975
 Shpg. Wt. 7 Lbs.



1

2 *Heathkit* 20-WATT HIGH FIDELITY
AMPLIFIER KIT

This Heathkit Model offers you the least expensive route to high fidelity performance. Frequency response is ± 1 db from 20-20,000 cps. Features full 20 watt output using push-pull 6L6's, and incorporates separate bass and treble tone controls. Preamplifier and main amplifier are built on the same chassis. Four switch-selected compensated inputs and separate bass and treble tone controls provide all necessary functions at minimum investment. Features miniature tube types for low hum and noise.

Uses 12AX7, two 12AU7's, two 6L6G's and a 5V4G. A most interesting "build-it-yourself" project, and an excellent hi-fi amplifier for home use. Well suited, also, for public address applications because of its high power output and high quality audio reproduction. Another Heathkit "best-buy" for you!

MODEL A-9B
\$3550
 Shpg. Wt. 23 Lbs.



2

3 *Heathkit* 7-WATT
AMPLIFIER KIT

The redesigned Model A-7D features a new type output transformer for tapped screen operation, and provides improved sensitivity, reduced distortion, and increased power output.

The full 7-watt output of the Model A-7D is more than adequate for normal home installations. Frequency characteristics are $\pm 1\frac{1}{2}$ db from 20 to 20,000 cps. Potted output and power transformers employed. Push-pull output — detailed construction manual — top quality parts — high quality audio without great expense. Output transformer tapped at 4, 8, and 16 ohms. Bass and treble tone controls provided on the front chassis apron.

MODEL A-7D
\$1695
 Shpg. Wt. 10 Lbs.

Model A-7E: Provides a preamplifier stage with two switch-selected inputs and RIAA compensation for variable reluctance or low level cartridges. Preamplifier built on same chassis as main amplifier. Model A-7E. Shipping weight 10 lbs. \$18.50.



3

**HEATH
 COMPANY**
 A SUBSIDIARY OF DAYSTROM INC.

BENTON HARBOR 15, MICHIGAN

March, 1956

87

Brand New HEATHKIT HIGH-FIDELITY FM TUNER KIT

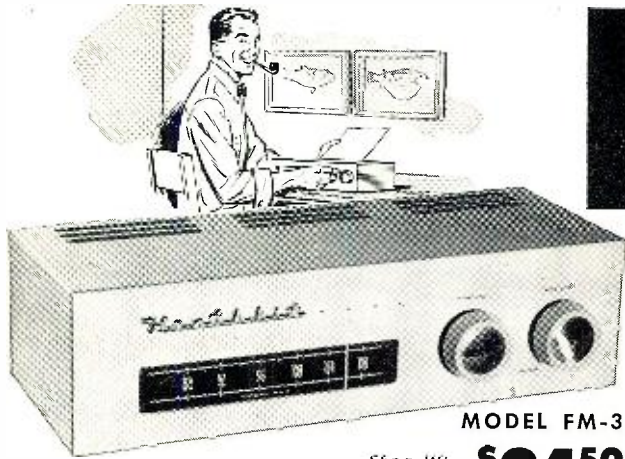

MODEL FM-3

Shpg. Wt. **\$24.50**
7 lbs.
(with cabinet)

The new Heathkit Model FM-3 features tremendous circuit improvements and brand new physical design. Sensitivity is better than 10 μv . for 20 db of quieting, and it employs a completely modern tube line-up for high gain and stable operation. Incorporates its own power supply, and has provision for low-level or high-level output at low impedance.

The attractive Model FM-3 matches the WA-P2 Pre-amplifier in color, styling, and physical size. Incorporates automatic gain control, a highly stabilized oscillator, and illuminated tuning dial. Educational treatment of construction manual simplifies assembly for the newcomer to electronics. IF and ratio transformers are pre-aligned, and the front-end tuning unit is pre-assembled and aligned. Uses 6BQ7A as a cascode type RF stage, 6U8 oscillator-mixer, two 6CB6's as IF amplifiers, a 6AL5 ratio detector, a 6C4 audio amplifier, and 6X4 rectifier.

Features

- ▶ Brand New, Modern FM Circuit Using Latest Type Miniature Tubes.
- ▶ Low-Noise Cascode RF Stage—Two IF's—Ratio Detector—Stage of Audio.
- ▶ Extremely Good Sensitivity and Band-Pass for Outstanding Performance.
- ▶ Strikingly Attractive Satin-Gold Finish to Match Heathkit Model WA-P2 Pre-amplifier.
- ▶ Compact Physical Dimensions for Most Pleasing Appearance and Increased Circuit Efficiency.

HEATHKIT BROADCAST-BAND RECEIVER KIT

Build your own radio receiver with confidence, even if you are a beginner. Complete instructions supplied.

Features transformer-type power supply, high-gain miniature tubes, built-in antenna, $5\frac{1}{2}$ " speaker, and planetary tuning from 550 Kc to 1500 Kc. Adaptable for use as AM Tuner and phono amplifier. Educational treatment of the construction manual helps the beginner learn about radio circuits and parts as he builds.

CABINET: Fabric covered plywood cabinet with aluminum panel as shown. Part 91-9, Shpg. Wt. 5 lbs., \$4.50.



MODEL BR-2

\$17.50 Less Cabinet
Shpg. Wt. 10 lbs.

Are you on our mailing list? If not—how about sending us your name?

ORDER BLANK



from _____

- SHIP VIA
- Parcel Post
 - Express
 - Freight
 - Best Way

QUANTITY	ITEM	MODEL NO.	PRICE

NOTE: ALL PRICES SUBJECT TO CHANGE WITHOUT NOTICE.

Enclosed find () check () money order for _____, Please ship C.O.D. () postage enclosed for _____ pounds.

On Express orders do not include transportation charges—they will be collected by the express agency at time of delivery.

ON PARCEL POST ORDERS include postage for weight shown. ORDERS FROM CANADA and APO's must include full remittance.

HEATH COMPANY A Subsidiary of Daystrom, Inc. **BENTON HARBOR 15, MICHIGAN**

New Hi-Fi-Audio Equipment

HEATH SPEAKER KIT

The *Heath Company*, Benton Harbor, Michigan has recently introduced a speaker system kit, the Model SS-1. Response is essentially flat with performance within ± 5 db from 50 to



12,000 cps. The enclosure measures only 11½" high, 23" wide, and 11¼" deep. The cabinet comes in knocked down form and is made of furniture-grade plywood that can be finished according to the user's choice. The broad "picture frame" molding (which is factory assembled) adds a professional touch to the finished cabinet.

The cabinet is of the duct-ported, bass-reflex type, and the system features two separate speakers. A balance control allows level adjustments on the tweeter. Both of the *Jensen* speakers come ready for installation. Write the manufacturer for full information on the Model SS-1.

B.C. BAND TUNER

J. W. Miller Company, 5917 S. Main Street, Los Angeles 3, California is now offering a unique germanium diode broadcast-band tuner, the No. 595.

Housed in an ebony black or ivory Bakelite cabinet, the new tuner incorporates special high-"Q" coils (600) which have recently been developed as the result of the application of new materials.

The audio output of the tuner is proportional to the input signal and will

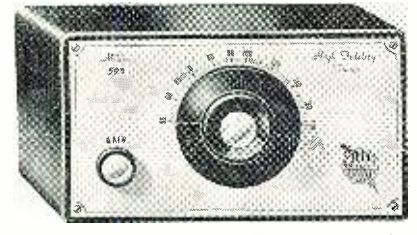

vary from .07 to .7 volt for stations within a 20-25 mile radius. This negative mutual-coupled bandpass tuner requires no power, selectivity is 20 kc., and it is noise-free. The company recommends the unit especially for use

March, 1956

as a companion unit to an FM tuner for high-fidelity binaural reception since it is free from a.c. hum and tube noise.

A data sheet on this new unit is available from the manufacturer on request.

H.F. UNIT

A new "Signature" high-frequency unit utilizing a ring radiator rather than a dome-shaped diaphragm has been developed by *James B. Lansing Sound, Inc.*, 2439 Fletcher Drive, Los Angeles 39, California.

Designed for 2500 cycle crossover, the new unit bears the model number 075. It has been especially designed for use with the company's "Signature" extended range speakers.

Application of the radiating ring principle results in negligible resonance



and distortion-free sound radiation from 2500 cps to beyond the limits of audibility. The ring radiates into the annular, rather than tubular opening of an exponentially tapered horn. All of the radiating surface is at, and very close to, the throat of the horn, thereby eliminating phase disturbance and, at the same time, eliminating the need for an expensive, precision-machined phasing plug.

The unit measures 3⅞" x 3¼" and weighs about 8 pounds. Power input is 20 watts above 2500 cps and impedance is 16 ohms.

"PROTECT-O-PAD"

The Televox Co., 46 Lakeview Avenue, Yonkers, N. Y. is marketing a compact and handy "record float" which is designed to protect records against turntable dust and dirt as well as scratches.

The unit, known as the "Protect-o-pad," absorbs shock and vibration and cushions the record drop on changers.

Get your money's worth OUT OF TEST EQUIPMENT!

WORK BETTER, FASTER WITH FEWER INSTRUMENTS!

No sooner do you buy one new test instrument than another type comes along that is said to be even better and more useful. You soon realize you've got to draw the line somewhere!

The answer is to really learn about instruments . . . to KNOW exactly what each type CAN and CANNOT do. Actually, you can do first class work with only a few basic instruments. You can save hundreds of dollars by learning to use old instruments more fully.

Remember! *It isn't so much the instruments you use . . . it's the instrument "KNOW HOW" that counts!* And that's where this famous book can be worth its weight in gold!

GET MORE WORK OUT OF YOUR OLD INSTRUMENTS

BASIC ELECTRONIC TEST INSTRUMENTS by Rufus Turner covers instruments and test equipment from a practical, on-the-job standpoint. No useless theory! In 255 pages and with more than 170 illustrations it shows you how to select the right instruments and how to use them on all kinds of jobs.

It shows how to modernize old types and use them in new ways. It helps you avoid buying unnecessary instruments; teaches you work-saving testing short cuts; shows how to evaluate instrument readings fast and accurately.

COMPLETE WORKING DATA ON OVER 60 INSTRUMENT TYPES

Over 60 types . . . from the latest TV sweep, marker and linearity pattern generators to grid-dip oscillators, special purpose bridges and all the old standbys from V-O-M's signal generators to oscilloscopes and dozens more . . . are fully covered.

Written especially for servicemen, students, amateurs and experimenters, BASIC ELECTRONIC TEST INSTRUMENTS is the only book of its kind. It saves you money . . . helps you earn more money! Price only \$4.00 (\$4.50 outside U.S.A.)

10-DAY FREE TRIAL

- Dept. RN-36 Rinehart & Co., Inc.
- 232 Madison Ave., New York 16, N. Y.
- Send Turner's 255-page BASIC ELECTRONIC TEST INSTRUMENTS book for 10-day FREE EXAMINATION. If I decide to keep book, I will then remit \$4.00 plus postage. Otherwise, I will return book postpaid promptly and owe you nothing.
- (Send \$4.00 with order and we pay postage. Same money-back guarantee.)

Name

Address

City, Zone, State

OUTSIDE U.S.A.—Price \$4.50 cash only. Money back if book is returned in 10 days.

Rinehart Books are sold by leading book stores

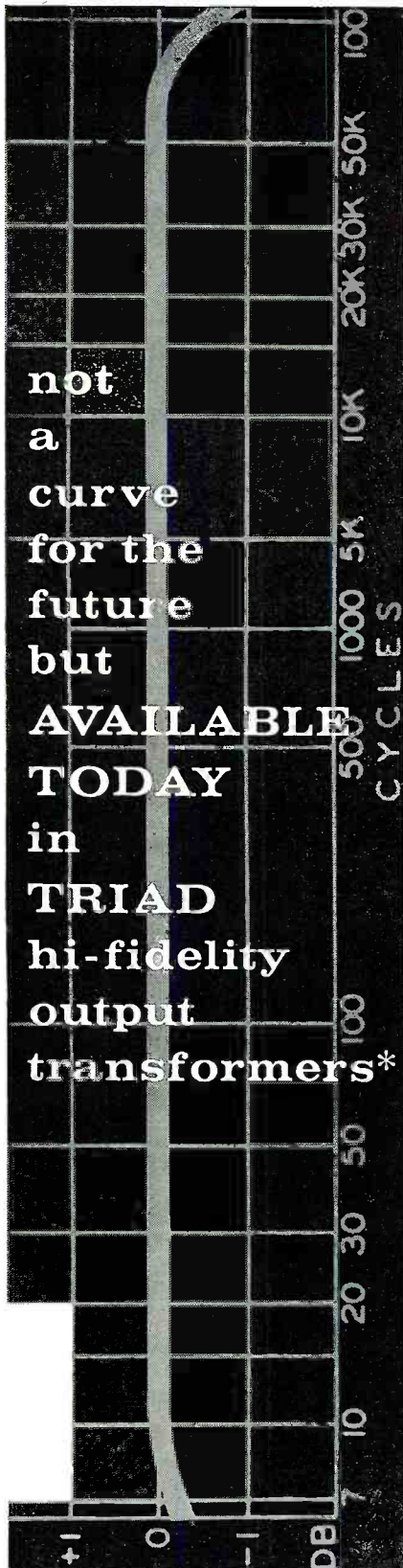

not
a
curve
for the
future
but
**AVAILABLE
TODAY**
in
TRIAD
hi-fidelity
output
transformers*

*Curve plotted from stock amplifier using TRIAD HSM-189 output transformer, as listed in General Catalog.

Write for Catalog TR-55F



TRIAD
TRANSFORMER CORP.

4055 Redwood Ave., Venice, California



An added feature of this unit, on which a patent is pending, is a permanent strob disc printed on the top of the pad to permit a continuous check of turntable accuracy.

Write the firm for a data sheet on this device as well as information as to price and availability.

20-WATT AMPLIFIER

Electronic Instrument Co., Inc., 84 Withers Street, Brooklyn 11, New York is now offering a complete 20-watt "Ultra-Linear," *Williamson*-type am-

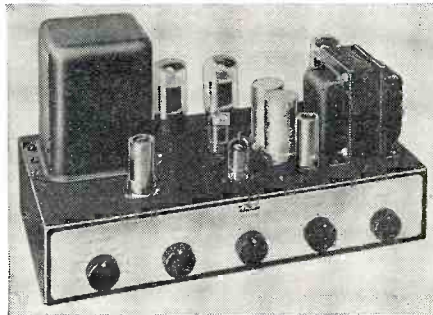

plifier and preamplifier which is available in either kit or factory-wired form.

Featuring five positions of feedback equalization, variable turnover feedback tone controls, a *Centralab* "Comptrol," and separate panel level control, the new *Eico* HF20 also offers 34 watts peak power, frequency response of $\pm .5$ db from 13 to 35,000 cps and ± 1.5 db from 7 to 50,000 cps. IM distortion is 1.3% measured at 50 and 6000 cycles/4:1 at 20 watts. Four, eight, and sixteen ohm speaker taps are also provided.

In kit form, the amplifier comes with complete, easy-to-follow step-by-step instructions. Complete details on both this kit and the factory-wired unit are available from the company.

HI-FI AM-FM TUNER

The Theatre and Sound Products Department of *Radio Corporation of America*, Camden, New Jersey has just announced the availability of a new high-fidelity AM-FM tuner which features an electronic eye to facilitate pin-point radio tuning.

The new unit is electrically matched for plug-in use with associated *RCA*

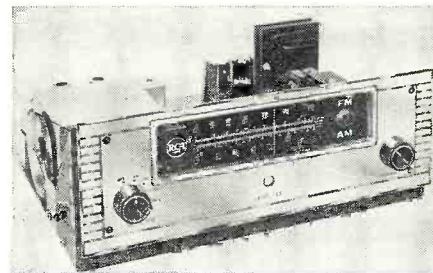

hi-fi components in home assembled music systems. It features an extended frequency range of 20 to 15,000 cps and provides an audio output of 1.5 volts. Other features of the Model ST-4 include variable frequency control of FM for lock-in tuning of weak stations adjacent to strong ones; tuner output

level set, which permits selection of desired level by screwdriver adjustment; minimum radiation, below FCC requirements; low-impedance loop antenna; and high signal-to-noise ratio, to minimize distortion and interference.

The unit measures $6\frac{1}{2}$ " high, $14\frac{1}{4}$ " wide, and $12\frac{3}{4}$ " deep. Designed for simplified operation and mounting, it features only two controls and requires only one cutout for tuning dial and controls.

HIGH-POWER AMPLIFIER

Fairchild Recording Equipment Co., 154th Street and 7th Avenue, White-stone, New York has added a high power amplifier, the Model 275, to its line of audio equipment.

Designed to deliver 75 watts continuously and capable of peaks up to 150 watts, this low distortion unit is conservatively rated at 65 watts with IM distortion less than .5 per-cent (any combination of frequencies within the audio spectrum).

The amplifier measures $12\frac{1}{2}$ " x 7" x 7" and weighs 32 pounds. It is styled to match the firm's other audio equip-

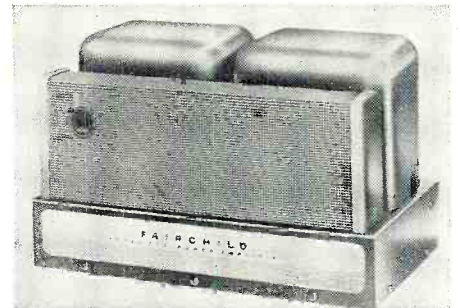

ment items. Three a.c. power outlets are provided for tuner, tape recorders, turntable, etc., along with a master gain control. Output impedances are 4, 8, and 16 ohms.

TURNOVER CARTRIDGE

Ronette Acoustical Corporation, 135 Front Street, New York 5, N. Y. is now offering a new item in its line of turnover cartridges, the TO-284PX.

The new unit, one of the firm's TO-284 series, is a crystal type. It features reduced stylus mass and increased compliance over the predecessor models. The Model TO-284PX has two non-interacting sapphire styli of 1 mil and $2\frac{1}{2}$ mil point radius. It is internally equalized for the "Ortho-phon" recording characteristics and requires no preamplifier or equalizer. It is guaranteed against climatic variations.

BATTERY-OPERATED RECORDER

Electric & Musical Industries, Ltd. of England has developed a new battery-operated magnetic tape recorder that is being distributed in the United States by *Ercona Corporation*, 551 Fifth Avenue, New York 17, N. Y.

Weighing only $14\frac{1}{2}$ pounds, including batteries, the *E.M.I.* Series L-2 was designed especially for applications where sound quality is the paramount

consideration: remote audio, radio and TV pickup, motion picture sound, or the recording of conferences, meetings, speeches, and interviews.

The recorder measures only 14" x 8" x 7" and uses standard 5" reels of ¼" tape. It is available in three models for 3¼ ips, 7½ ips, or 15 ips. Frequency response at 15 ips is within ±2 db of the response at 1000 cps, between 50 and 7000 cps, and within ±3 db from 7000 to 10,000 cps. Separate recording and playback heads and amplifiers are provided to facilitate monitoring and instantaneous playback.

HARTLEY SPEAKER

Hartley Products Co., 521 East 162nd Street, New York 51, New York has just announced the addition of a new speaker to its line.

The Model 215 is resonance-free through the response range of 1 to 18,000 cps. With a 5 pound magnet, a peak power of 20 watts, the speaker employs one cone, sectioned, with a mechanical crossover that avoids any break in tone. A cloth suspension gives a movement of half an inch.

Full technical data on the 215 is available from the manufacturer.

AUDIO GENERATOR KIT

Heath Company, Benton Harbor, Michigan is now offering an audio generator in kit form, the AG-9.

The new unit features step-tuning from 10 cps to 100 kc. with three rotary switches providing two significant figures and a multiplier. Distortion is less than .1 per-cent and the frequency is accurate to within ±5 per-cent.

The output may be monitored on a 4½" meter that reads voltage or decibels. Both variable and step-type attenuation are provided. The meter reads zero-to-maximum at each attenuator position. Output ranges are 0-.003, .01, .03, .1, .3, 1, 3, and 10 volts.

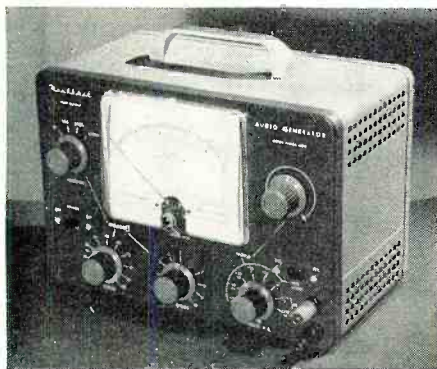

Step tuning provides rapid positive selection of the desired frequency and allows accurate return to any given frequency.

Complete data on this ready-to-assemble kit is available from the manufacturer.

VOLUME EXPANDER

Lincoln Records, Inc., 84 Merrick Road, Amityville, New York is currently marketing a new volume expander which is designed to restore the original orchestral range to recordings.

March, 1956



NEW! And Only \$99⁵⁰!

THE 
FISHER
FM TUNER
MODEL FM-40

HERE IT IS, a FISHER FM Tuner — with all that the name implies — for only \$99.50. Through the years it has been our policy to bring equipment of FISHER calibre within the reach of the widest possible audience. Rarely has that objective been more spectacularly attained. For the FM-40 represents one of our greatest values in almost two decades. It is a superb combination of engineering excellence and dazzling performance at moderate cost. Its specifications, conservatively outlined below, are your best index to the quality of this instrument.

Important Features of THE FISHER FM-40

- Meter for micro-accurate, center-of-channel tuning. ■ Sensitivity: 3 microvolts for 20 db of quieting. ■ Uniform response, ± 1 db, 20 to 20,000 cycles.
- Three-gang variable capacitor. ■ Three IF stages and a cascode RF stage.
- Two outputs: Detector/Multiplex (on switch) plus cathode-follower-type Main Audio, permitting leads up to 200 feet. ■ Two Controls: AC Power/Volume, and Station Selector. ■ Chassis completely shielded and shock-mounted; includes bottom plate. ■ 8 tubes: 1—6BQ7A, 1—6U8, 3—6BH6, 1—6AL5, 1—12AU7A, 1—6X4. ■ Folded dipole antenna supplied. ■ Heavy flywheel tuning mechanism. ■ Beautiful brown-and-gold brushed-brass, front control panel. ■ Highly legible, edge-lighted glass dial scale (accurately calibrated slide-rulo type) with logging scale. ■ Self-powered. ■ SIZE: 12¾" wide, 4" high, 8¾" deep, including knobs. ■ SHIPPING WEIGHT: 15 pounds.

Professional FM Tuner • Only \$99.50

MAHOGANY OR BLONDE CABINET: \$14.95

Prices Slightly Higher West of the Rockies

WRITE TODAY FOR COMPLETE SPECIFICATIONS

FISHER RADIO CORP., 21-23 44th DRIVE • L. I. CITY 1 • N. Y.

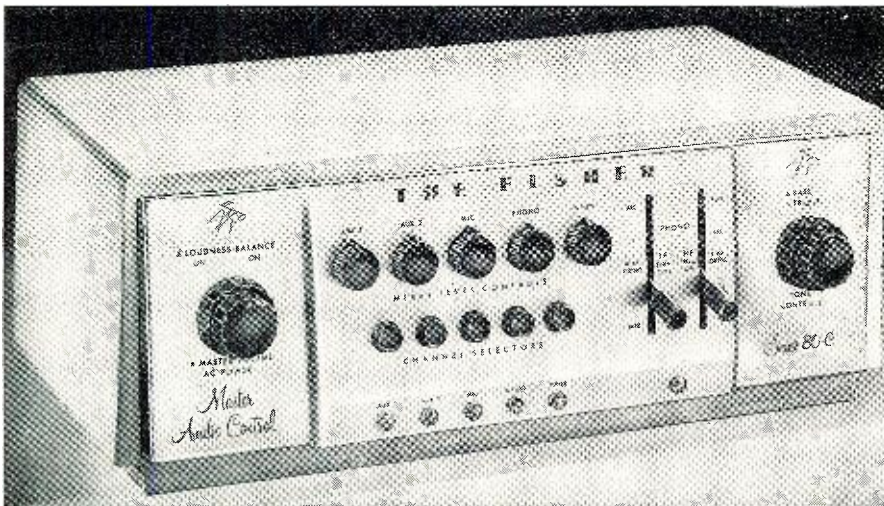

“Breathtaking!” — EDWARD
TATNALL
CANBY

THE
FISHER
Master Audio Control

SERIES 80-C

“**S**TARTLINGLY DIFFERENT,” says Edward Tatnall Canby, *Audio Magazine*. “Has everything, at a very reasonable price for top-quality hi-fi equipment. The easiest to read and operate I’ve ever seen. The specs on performance are breathtaking and the over-all quality of its electrical operation is pretty closely comparable to that of a professional broadcast console control board. This is the current standard for really hi-fi operation of controls in the home. Hum, distortion, *et al* are so low as to be inaudible and mostly unmeasurable in the lab. And all this, mind you, in the middle price range.”

Chassis Only, **\$99.50** • Mahogany or Blonde Cabinet, **\$9.95**

Remarkable Features of THE FISHER 80-C

- Professional, lever-type equalization for all current recording characteristics.
- Seven inputs, including two Phono, Mic and Tape.
- Two cathode-follower outputs.
- Complete mixing and fading on two, three, four or five channels.
- Bass and Treble Tone Controls of the variable-crossover feedback type.
- Accurately calibrated Loudness Balance Control.
- Self-powered.
- Magnetically shielded and potted transformer.
- DC on all filaments; achieves hum level that is inaudible under any conditions.
- Inherent hum: non-measurable. (On Phono, 72 db below output on 10 mv input signal; better than 85 db below 2v output on high-level channels.)
- IM and harmonic distortion: non-measurable.
- Frequency response: uniform, 19 to 100,000 cycles.
- Separate equalization and amplification directly from tape playback head.
- Four dual-purpose tubes, all shielded and shock-mounted.
- Separate, high-gain microphone preamplifier.
- Push-Button Channel-Selectors with individual indicator lights and simultaneous AC On-Off switching on two channels (for tuner, TV, etc.)
- Master Volume Control plus 5 independent Level Controls on front panel.
- 11 Controls plus 5 push-buttons.
- Three auxiliary AC receptacles. size: Chassis, 12 $\frac{3}{4}$ " x 7 $\frac{3}{4}$ " x 4 $\frac{1}{4}$ " high. In cabinet, 13-11 $\frac{16}$ " x 8" x 5 $\frac{1}{4}$ " high. Shipping weight, 10 pounds.

Prices Slightly Higher West of the Rockies

WRITE TODAY FOR COMPLETE SPECIFICATIONS

FISHER RADIO CORP. • 21-23 44th DRIVE • L. I. CITY 1, N. Y.

This accessory unit may be installed in any system in minutes with a screwdriver the only tool required. Since not all recordings contain the same amount of compression, provision is made to set the volume expansion from 30 to 45 db.

Once set, the expander operates automatically. Built-in panel lamps indicate crescendos. The unit may also be used as a compressor for home recorded discs. Volume compression up to 40 db can be obtained.

STATIC ELIMINATOR KIT

Nuclear Products Company, 10173 E. Rush Street, El Monte 2, California has recently introduced a complete static eliminating unit which provides a practical method of eliminating static electricity from musical records and high-fidelity systems.

The new “Staticmaster” system consists of a flexible arm, an ionizing unit, and a hi-fi record brush, both containing radioisotope elements. The flexible arm is used to position the ionizing unit so that static charges are kept neutralized even while the record is playing. The brush is used to clean records and rid them of dust, lint, and static while rotating on the turntable.

AM-FM TUNER-AMPLIFIER

Rauland-Borg Corporation, 3515 West Addison Street, Chicago 18, Illinois has recently introduced a new AM-FM tuner, preamp, and amplifier packaged in a single unit as the Model HF355 “Golden Ensemble.”

The combination has separate front ends for FM and AM. The FM section has tuned r.f. stage, discriminator with dual limiters, a.f.c. with defeat on func-

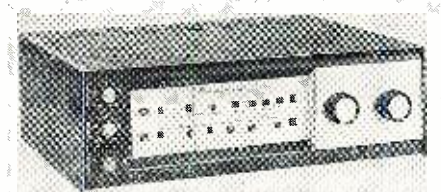

tion switch, drift-compensated circuits, 300-ohm balanced antenna input, and comes equipped with a dipole antenna. The AM section has tuned r.f. stage and a ferrite loop. The unit has an input for magnetic or ceramic pickups with RIAA response curve, separate bass and treble tone controls, and a choice of regular volume or loudness control. Frequency response is 20 to 20,000 cps \pm .5 db on FM; 20 to 5000 cps \pm 3 db on AM; and 20 to 20,000 cps \pm .5 db on phono. The amplifier is a 12-watt unit.

The entire unit measures only 5 $\frac{1}{4}$ " high, 15 $\frac{3}{4}$ " wide, and 11 $\frac{1}{2}$ " deep. It is housed in a black cabinet with marbled-gold finish.

“TINY-MITE” SPEAKER SYSTEM

University Loudspeakers, Inc., 80 South Kensico Ave., White Plains, New York has recently introduced a new three-way speaker system which has been designed for applications where both space and budgets are limited.

RADIO & TELEVISION NEWS

Suitable for corner installations or against a flat wall, this compact, well-proportioned enclosure features a Model 308 triaxial speaker. The "Tiny-Mite" enclosure is made of selected hard woods and choice veneers, finished to accent the natural beauty of the wood grain. Use of fully-braced $\frac{3}{4}$ " wood throughout insures rigid vibrationless joints to provide buzz-free performance.

The woofer section of the triaxial speaker features a specially treated diaphragm with an extra large voice coil complementing the company's exclusive "W" magnet for undistorted bass response. The "Diffusicone" device, through a 1000 cps mechanical crossover, provides full-bodied mid-range, while highs to 15,000 cps emanate from a "reciprocating flares" tweeter crossing over electrically at 5000 cycles.

-tone Arm Assembly

Webster-Electric Company of Racine, Wisconsin is now offering its new "Retract-o-matic" tone arm assembly for manual record players which provides positive protection both to record and needle even when it is dropped or slid across a record surface.

The new unit is said to be a foolproof replacement for portable record players and miniature phonographs for children. It features a crystal pickup in a special cartridge mounting that allows the needle to retract from the record surface the instant undue pressure is applied. It has a "push in" needle that requires no needle screw to hold firmly and can be inserted or removed with the fingers.

"Thumb Size" Mike

The Broadcast and TV Equipment Department of Radio Corporation of America, Camden, New Jersey has come up with the smallest dynamic microphone ever developed for radio



and television broadcasting, a "thumb-size" device that weighs less than three ounces.

The new unit is so small it can be carried completely concealed in the hand. It weighs only 2.3 ounces and can be worn around the performer's neck or clipped to lapel or dress.

Frequency response is 80 to 12,000 cps. It comes complete with lanyard and a 30-foot flexible cable. It measures $2\frac{3}{16}$ " in length and $1\frac{1}{16}$ " in diameter.

-30-

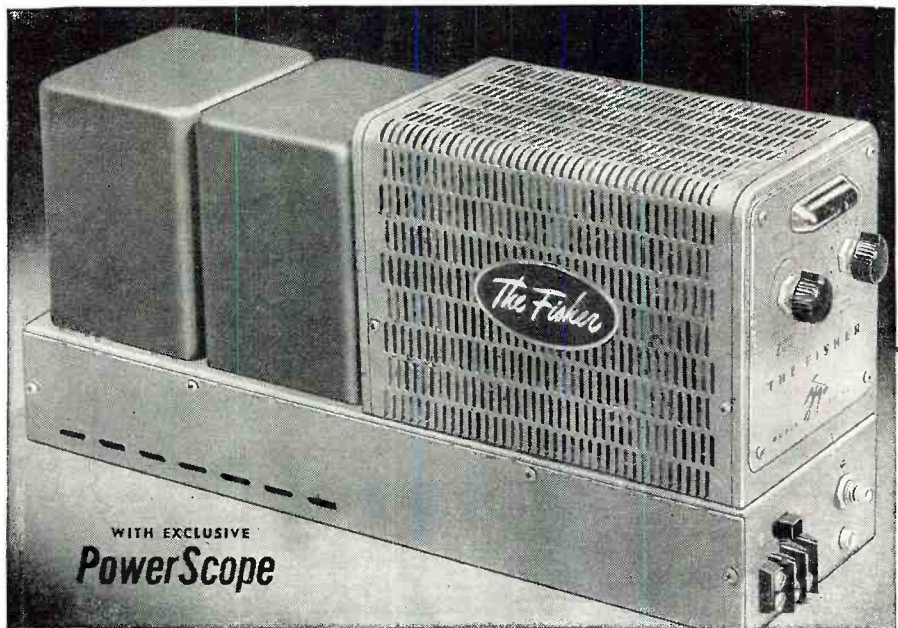

AN EXCEPTIONAL, NEW THIRTY-WATT AMPLIFIER • HANDLES SIXTY-WATT PEAKS!

Top Quality! Low Cost!

THE
FISHER

30-Watt Amplifier

MODEL 80-AZ

ANOTHER FISHER FIRST — our great new 30-watt amplifier with *A PowerScope*, a Peak Power Indicator calibrated in watts to show instantly the peak load on your speaker system. The new FISHER 80-AZ Amplifier is the first with a positive indicator to prevent voice coil damage. The Model 80-AZ is magnificent in appearance and quality.

Incomparable Features of THE FISHER Model 80-AZ

- High output — less than 0.5% distortion at 30 watts; less than 0.05% at 10 watts. Handles 60-watt peaks.
- Intermodulation distortion less than 0.5% at 25 watts and 0.2% at 10 watts.
- Uniform response 10 to 50,000 cycles; within 0.1 db from 20 to 20,000 cycles.
- Power output is constant within 1 db at 30 watts, from 15 to 35,000 cycles.
- Hum and noise level better than 96 db below full output!
- Three separate feedback loops for lowest distortion and superior transient response.
- Unique cathode feedback circuit for triode performance with the efficiency of tetrodes.
- Output transformer has interleaved windings and a grain-oriented steel core.
- Three Controls: *PowerScope*, *Z-Matic* and *Input Level*.
- Handsome, brushed-brass control panel (with sufficient cable for built-in installations.)
- Tube Complement: 1—12AT7, 1—12AU7A, 2—EL-37, 1—5V4-G, 1—*PowerScope* Indicator, 1—Regulator.
- 8- and 16-ohm outputs.
- Size: $15\frac{1}{2}$ x $4\frac{1}{4}$ x $6\frac{7}{8}$ " high. WEIGHT: 22 lbs.

Price Only **\$99.50**

Price Slightly Higher West of the Rockies

WRITE TODAY FOR COMPLETE SPECIFICATIONS

FISHER RADIO CORP., 21-23 44th DRIVE • L. I. CITY 1 • N. Y.

AMERICA'S FINEST VALUES IN "LOW COST" HIGH FIDELITY

ECONOMY 20 WATT AMPLIFIER \$22.95



NEW 1956 MODEL
 Push-Pull 6L6 Output Tubes
 Response 30—15,000 CPS
 Bass and Treble Tone Controls
 Input for Xtal or Dynamic Mike
 Input for Xtal or V.R. Phono

With CU-14Y, 12" Coax Speaker... \$32.95
 With P15-CR, 15" Coax Speaker... \$42.95
 With Imperial IV System... \$39.95
 With SP-12125CR... \$44.95
 With HF-33GE... \$69.95

Have tremendous high fidelity audio value. Response 30 to 15,000 cps. Electronic bass and treble boost by separate tone controls. This amplifier with any record changing crystal or variable reluctance cartridge, radio tuner or high impedance crystal or dynamic microphone. 20 watts power output. Use with any 4 or 8 ohm speaker or 250 ohm line. Chassis size, 7 1/2" x 10 1/2" x 7 1/2" high. Complete with tubes: 2-6L6, 2-6CA, 12AX7 and 5U4G. This is a terrific value. A ready to use high fidelity amplifier at less than the cost of a kit. Ship. wt. 17 lbs. Model HF-20, 20 watt Hi-Fi amplifier, McGee's sale price, \$22.95.

CONSOLE HI-FI SPEAKER SYSTEM \$49.95

12" G.E. PM WOOFER—10" PM MID-RANGE—8" G.E. MODEL 850 MID-HIGH RANGE SPEAKER AND 600 CYCLE L-C CROSSOVER NETWORK.

Have Juke Box tonality in your own home. Strictly High fidelity. Three speakers all connected to a 600 cycle frequency dividing network, so that only 2 wires feed the system from any 4 or 8 ohm radio or amplifier. A variable tone compensating control incorporated in the circuit makes drive ant highs or boomy lows to your own taste. Any amplifier that you now have will give you a much wider selection of acoustical arrangements with this speaker system. The 3-way system is shipped ready to connect to your amplifier or hi-fi radio. Equipped with a General Electric 12" woofer, an 8" famous G.E. 850 plus a 10" middle range speaker. Frequency response 30 to 15,000 cps. Take your choice of cabinet: blonde oak, walnut or mahogany. Specify finish desired when ordering: 37" high, 24" wide and 20" deep. Ship. wt. 75 lbs. Stock No. HF-33GE, Sale price, \$49.95. Model HF-44GE, console speaker system as above, except has a heavy duty 12" G.E. PM Model 1201, plus 8" G.E. PM Model 850, 10" mid-range speaker and 5" hard cone tweeter. Sale price, \$54.95. (Specify cabinet finish.) Model HF-55GE, super deluxe quality console speaker system, same as HF-33GE described above, except has 15" 24" oz. Alnico V magnet woofer, 10" mid-range PM speaker and Model 4401 University horn type tweeter. All 3 systems incorporate 600 cycle L-C type crossover network with variable tone compensating control. Model HF-55GE, Sale price \$69.95 (specify cabinet finish).

DELUXE CONSOLE SPEAKER SYSTEM \$89.50

15" UTAH WOOFER—8" GE—2-5" TWEETERS—CROSSOVER
 New, deluxe quality high fidelity console speaker system. Has 15" Utah woofer with 21 oz. Alnico V magnet, 8" model 850 G.E. mid-range speaker and two Utah 5" tweeters. This is the finest console speaker system that we offer. Available in blond oak or natural mahogany finish. Cabinet size, 43" high, 31" wide and 23" deep. Has 3/4" length doors with attractive hardware and ornament on grill below doors. All 4 speakers are connected to a 600 cycle frequency dividing network, so that there are only 2 wires to connect to any 4 or 8 ohm output of your radio or amplifier. Has variable tone compensating control built-in. Model HF-13CR4, deluxe quality Hi-Fi console speaker system. Ship. wt. 100 lbs. (Specify cabinet finish desired.) Sale price, \$89.50.

NEW IMPERIAL IV with General Electric

8 in. HIGH FIDELITY \$1995 SPEAKER

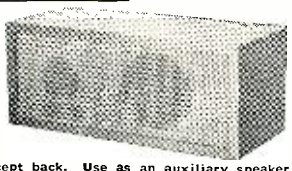

New 1955 Model IMPERIAL IV, High fidelity speaker system with General Electric 8" speaker. Housed in a high quality attractive covered plywood cabinet 10" x 10" x 24" long. Fully enclosed; covered on all sides except back. Use as an auxiliary speaker or with any high fidelity radio, amplifier or home music system. The IMPERIAL IV contains a General Electric Model 850 extended range high fidelity 8" PM speaker with 6.8 ohm. Alnico V magnet and curvilinear cone with 8 ohm voice coil and a 5" tweeter. Response 50 to 15,000 cps. Model IV Imperial \$19.95. Ideal for use with HF-20 and IMP-30 amplifiers described above.

FAMOUS STANDARD COIL CASCODE TUNERS

TV-2000 series Standard Coil cascode tuners complete with 6J6 and 6BK7 or 6BQ7 tubes. Thousands of TV sets use this famous tuner. Tuning 12 channels (2 thru 13). For 21 mc I.F. circuit. This tuner will give 2 to 1 better reception than the old pentode type. Any serviceman replace all older tuners with this cascode model. Available with either 27 1/2" or 43 1/2" shaft length. A tremendous purchase makes our low \$12.95 price possible. Specify shaft length desired. Stock No. TV-2000-3, 2 FOR \$25.00. Sale price \$12.95 each, 2 for \$25.00. Matching knobs for Standard Coil tuners. Set No. SCK-2 for fine tuning and channel selector. Set VCK-2, matching volume and contrast knobs. Either set only 59¢ a pair.

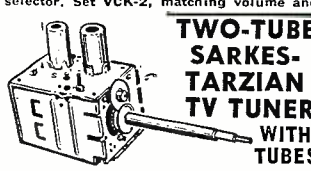

TWO-TUBE SARKS-TARZIAN TV TUNER WITH TUBES \$7.95 EA., 2 FOR \$15.00
 No. TT-3A, 2 tube Sarks-Tarzian 12 channel TV tuner. 21-25 mc. Popular in many makes. Ideal for general replacement use too. Has 6J6 and 6BQ7 tubes. Used in CBS, Arvin, Crosley, etc. Makes a good replacement for one tube tuners. 3 1/2" shaft. Takes SCK-2 knob set described above. Sale price, \$7.95 each, 2 for \$15.00 with tubes.

3-STATION MASTER SUB-STATIONS \$3.95 EACH \$1695
 Powerful 3 station master. Chrome plated metal case 7 1/2" x 6" x 5". 3 tube AC-DC amp. Press-to-stay switch on top. Volume control, switch and station selector on side. Master is quiet when call switch is pressed at sub. Use with one to 3 subs. Model MPM-A3, Ship. wt. 10 lbs., \$16.95. Matching sub-station PM-A5, with 5" PM I.F. call-back switch, \$3.95 ea., 3 for \$10.00. Requires 3 wire intercom cable, \$1.95 per 100 ft.; 500 ft. for \$8.95.

TELEVISION BOOSTER CLEARANCE SALE

Clearance sale on VHF television boosters for channels 2 through 13. RMS Model SP-5 metal case, brown wrinkle finish. Continuous variable tuning. 6AK5 tube. Also for late model sets with cascode front end. Sale price... \$4.95
 RMS Model SP-6, brown plastic case. Same as SP-5 except has variable gain control. (Pictured.) Sale price... \$4.95
 McCurdo-Silver GB-6B continuously variable. Includes FM band. 616 tube, brown plastic case. Sale price... \$5.95
 Standard Coil B-51 printed circuit booster. 6AK5 tube, brown plastic case. Sale price... \$6.95

IMPERIAL 30 WATT AMPLIFIER \$29.95

NEW 1956 MODEL
 Push-Pull 6L6 Output Tubes
 Response 15-20,000 CPS
 Bass and Treble Tone Controls
 Compensated Gain for G.E. Carl.
 Input for Xtal or Dynamic Mike



With CU-14Y, 12" Coax Speaker... \$39.95
 With P15-CR, 15" Coax Speaker... \$49.95
 With Imperial IV Speaker System... \$46.95
 With SP12125CR... \$51.95
 With HF-33GE... \$76.95

New 1956 model 7 tube Imperial 30 watt High Fidelity audio amplifier. A \$100.00 list value for only \$29.95. Features a heavy 4 lb., specially wound high fidelity output transformer with 15% inverse feed-back; push-pull 6L6 output tubes and frequency response from 15 to 20,000 cps. Matches 8 or 16 ohm speakers. You can center your entire custom music system around this low cost 30 watt amplifier. This Imperial 30, 30 watt amplifier may be used with any radio tuner or record player. It will drive any speaker system that you may have. Use from one to ten 8" speakers or any 12" or 15" coaxial speaker or any 3-way speaker system. Tone compensated input for either a crystal phono pickup or a General Electric variable reluctance pickup. Also, has input for crystal or high impedance dynamic microphone. 4 controls are mike gain, phono gain, tone and bass boost tone control. This amplifier weighs 21 lbs. net. Full size transformer components would cost you up to \$15.00 if purchased separately. Gold color chassis is 12 1/2" x 7 1/2" x 7 1/2" high. Complete with tubes: 6AT6, 6AU6, 6Z6U7, 2-6L6A, plus 5U4G rectifier. Stock No. IMP-30, 30 watt Imperial High-Fidelity amplifier complete with tubes and diagram. Ship. wt. 23 lbs., Sale price only \$29.95.

25 WATT HI-FI SPEAKER SYSTEM

2-12" Woofers 2-5" Tweeters Power Supply and L-C Crossover Network SALE PRICE \$2495

25 watt, High-Fidelity Dynamic Speaker System, complete with 2000 cycle genuine inductance-capacitance cross-over network, two 12" woofer speakers, two 5" high frequency tweeter speakers and separate 110 volt AC power supply for only \$24.95. Frequency response 20 to 18,000 cps. Both the woofers and the tweeters are fine quality dynamic speakers with fields excited to saturation by the power supply. Tweeters are special speakers made with cones designed to respond only to the high frequencies of the audio spectrum. The 2000 cycle cross-over network of the high quality inductance-capacitance type which prevents frequencies below 2000 cps from entering the tweeters and eliminates frequencies above 2000 cps from the woofer circuit. The cross-over network system is simple to connect to any 4 or 8 ohm output of your high fidelity audio amplifier or radio. No. SP-12125CR, High Fidelity Dynamic Speaker System, Ship. wt. 15 lbs., Sale price, \$24.95. No. SPS-12125, High Fidelity Dynamic Speaker System, as described above, but less the 2000 cycle cross-over network and with a separate attenuator control. Sale price, \$14.95. Ideal for use with HF-20 and IMP-30 amplifiers described above.

HIGH FIDELITY SPEAKERS

5" BLUE STREAK TWEETER... \$ 2.95
 8" BLUE STREAK... \$ 6.95
 15" BLUE STREAK WOOFER... \$16.95
 Model HF-8J, 8" "Blue Streak" High Fidelity wide range speaker. This one speaker properly baffled will give excellent response to both high and low frequencies and terrific response through the very important middle range. Has 6.8 ohm. Alnico V magnet with wide range curvilinear cone and 8 ohm voice coil. Response essentially flat from 35 to 12,500 cps. Perfect for high fidelity radios, amplifiers and professional music systems. Ship. wt. 6 lbs. Model HF-8J, Sale price, \$6.95.
 Model HF-15WF, new 15" "Blue Streak" Hi-Fi woofer. Has 21 1/2" oz. Alnico V magnet with one piece cone and 1 1/4" 8 ohm voice coil. Will give excellent response from 50 to 9500 cps. Takes 18 to 25 watt peak. Ship. wt. 12 lbs. Sale price, \$16.95.

NEW—LOW COST

HIGH FIDELITY MICROPHONES



Special Sale! Model M28-KT, high quality imported crystal lapel microphone. Very trim and neat in appearance. Polished chrome case 1 1/2" x 5/8" thick with clip on back and 5 ft. shielded plastic cable. Hi-Fi response, comparable or better than lapel microphones selling for \$10 to \$15 net. Shipped with 3 connectors: pin plug, phone plug and screw-on type. A fine addition to any tape recorder or audio amplifier. Stock No. M28-KT, Sale price, \$3.95.
 Deluxe Model M14-KT, High Fidelity imported crystal microphone for use with any amplifier or tape recorder. Attractive brilliant finish is a combination of polished chrome and opalescent tan lacquer. Has full swivel head and 5 ft. shielded plastic cable. A fine addition to any amplifier or tape recorder. Comparable to microphones selling for \$15 to \$25 net. Shipped with plugs to fit most recorders and amplifiers. Stock No. M14-KT, Sale price, \$7.95. Fits standard 5/8" mike stand.
 Model M20-KT, all purpose crystal microphone. Hi-Fi response. A terrific imported value. Comparable or better than microphones selling for \$10 to \$12 net. Fits standard 5/8" mike stand. Shipped with pin plug, phone plug and screw-on connector. Stock No. M20-KT, Sale price, \$4.95.

AIR KING FM-AM TUNER

SELF POWERED Use with any Audio Amplifier SALE PRICE \$2499

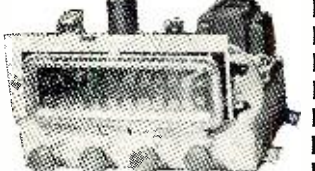

Air King factory built, 6 tube self-powered FM-AM radio tuner. Receives broadcast 540 to 1520 kc. an FM 88 to 108 mc. Use with any Hi-Fi audio amplifier or connect it to your TV set for FM-AM reception. Selector switch has 4 positions for TV-Phono-FM and AM. 3 other controls are volume-off-on, tone and tuning. With tubes: 12A7, 2-6AU6, 6AL5, 6X07, and 5Y3 rectifier. Chassis size 1 1/2" x 7 1/2" x 6 1/2" high. Illuminated slide rule dial 7 1/2" x 2 1/2", with eutecticon plate and knobs. Self-powered with its own power transformer. Air King FM-AM tuner chassis No. 703 as used in Air King model 7K10 combination TV-Radio-Phono with power supply included. Note: A separate audio amplifier is required to operate a speaker. Stock No. AIR-K6, self-powered FM-AM tuner, complete with tubes, knobs and diagram. Ship. wt. 10 lbs. Sale price, \$24.99.

McGEE RADIO COMPANY PRICES F.O.B. KANSAS CITY TELEPHONE VICTOR 5092
 SEND 25% OR FULL REMITTANCE WITH ORDER. 1903 McGEE ST., KANSAS CITY, MISSOURI
 BAL. SENT C.O.D.

14 TUBE ESPEY HI-FI CUSTOM FM-AM CHASSIS \$84⁹⁵

LATEST 1956 MODEL WITH RESPONSE FROM 10 TO 22,000 CPS

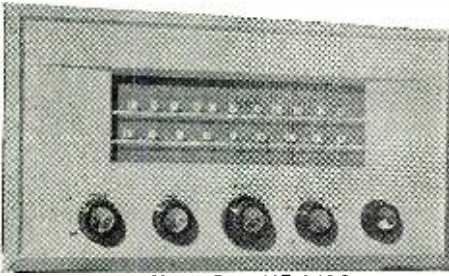

NEW MODEL HF-250C. A FULL HIGH FIDELITY AUDIO AMPLIFIER AND FM-AM TUNER—ALL ON ONE CHASSIS

- ★ PUSH-PULL 6V6 OUTPUT
 - ★ TWIN TONE CONTROLS
 - ★ INPUTS FOR CRYSTAL OR V.R. PHONO, TAPE OR TV
 - ★ WILLIAMSON TYPE CIRCUIT
 - ★ ULTRA-LINEAR RESPONSE
- SALE PRICE \$84⁹⁵**
- LESS SPEAKER WITH MONARCH UA6U CHANGER \$112.95

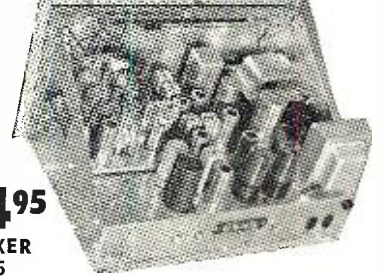

ESPEY MODEL HF-250C
With 12" Phillips Model 9760M Speaker... \$ 99.95
With 12" Phillips Model 9762M Speaker... 119.95
 Buy either of these new Duotone "Norelco" speakers with your Espey chassis. Made by Phillips of Holland. Features Ticonal magnet, improved cone design, built-in mechanical cross-over and copper ring fitted into air gap keeps voice coil impedance independent of frequency.
 Model 9760M, \$54.95 list 12" Phillips speaker, response 30 to 20,000 cps, rated at 20 watts with Model HF-250C Espey chassis, both for only \$99.95.
 Model 9762M, \$99.95 list 12" Phillips speaker, response 22 to 20,000 cps, rated at 20 watts with Model HF-250C Espey chassis, both for only \$119.95.
With 15" Utah Coaxial PM Speaker... \$99.95

New 1956 model, 14 tube FM-AM chassis. A true Hi-Fidelity receiver built by a nationally famous maker of fine custom chassis. Espey Model HF-250C, 14 tube FM-AM chassis with push-pull 6V6, 10 watt radio. You could spend \$200 to \$250 for a separate tuner and amplifier and not have the quality of this receiver. Ultra-Linear output used in Williamson type circuit gives frequency response of 10 to 22,000 cps. Output taps of 4, 8 and 16 ohms. Separate RF stages for FM and AM assure high sensitivity. Temperature compensated FM front end for minimum drift. Separate bass and treble tone controls. Pre-amp for all types of magnetic cartridges. 2" input for crystal phono, tape recorder or TV. 3 position equalizer for accurate reproduction of all records. Built-in antennas for both FM and AM. Response plus or minus 1 db from 10 to 22,000 cps. Harmonic distortion less than 1%. Sensitivity: FM, 8 mv for 30 db quieting; AM, 75 mv for 6 db signal to noise ratio. Off-on-volume and equalizer are combined on a concentric control. Has 2 AC outlets on rear of chassis. Beautiful edge lighted flywheel inertia slide rule dial. Size: 7 3/4" x 13 1/2" x 10" deep. Ship. wt. 24 lbs. (not suitable) Model HF-250C, Sale price, \$84.95. With heavy duty Utah 15" coaxial PM speaker, both for only \$99.95.

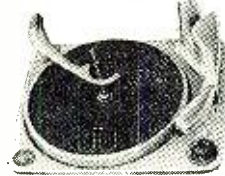

NEW IMPORTED MONARCH HIGH FIDELITY AUTOMATIC CHANGER
 WITH GOLDRING #500 VAR. REL. CARTRIDGE **SALE PRICE \$29⁹⁵**

Monarch Model UA6U—new, imported high fidelity 3 speed automatic record changer. Plays 7", 10" and 12" records automatically. Intermixes records of the same speed in any order. Features a 4 pole high fidelity motor eliminating rumble and wow. Pickup automatically returns to rest and motor turns off after last record has played. Full size 10" turntable has molded rubber pallet for better record cushioning. Base size, 10 7/8" x 12 3/4". Tone arm is counter balanced to assure minimum record wear. The changer features, at no added cost the regular \$9.90 net value Goldring #500 variable reluctance cartridge for the finest high fidelity record reproduction. Output 10 millivolts. Response, 20 to 16,500 cps. It requires the same input gain as popular American made variable reluctance cartridges. Mounted UA6U, Monarch automatic changer with Goldring cartridge, ship. wt. 15 lbs. Sale price, \$29.95; Large spindle for 45 RPM records, \$1.88 extra.



McGee's Famous 12 AND 15 INCH COAXIAL P.M. HIGH FIDELITY SPEAKERS
\$12⁹⁵ \$23⁹⁵
 12-Inch Model CU-14Y
 15-Inch Model P15-CR

Model CU-14Y, 12" high fidelity coaxial PM speaker. Response from 30 to 17,500 cps. Full 6.8 oz. Alnico V magnet in the 12" woofer. Special coaxially suspended high frequency tweeter. Built-in crossover network. Only two wires to connect to your radio or amplifier. Matches 3.2 to 8 ohm output. Don't confuse this speaker with many cheap speakers that are offered. This is a fine quality speaker. Stock No. CU-14Y. Sale price \$12.95 each, two for \$25.00.
 Model P15-CR, 15" high fidelity coaxial PM speaker. Response down to 20 cps. Full 21 1/2 oz. Alnico V magnet in the 15" woofer. Specially made, coaxially suspended 5" high frequency tweeter. Built-in crossover network. Only two wires to connect. Matches 3.2 to 8 ohm output transformer. A regular \$62.50 list speaker. Model P15-CR, McGee's Sale Price, \$23.95.

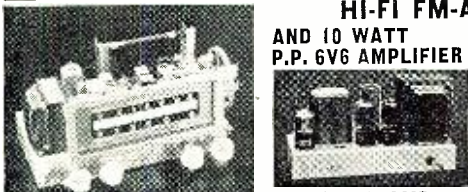

HI-FI FM-AM TUNER AND 10 WATT P.P. 6V6 AMPLIFIER
BOTH FOR \$44⁹⁵

New Hi-Fi self-powered FM-AM tuner with 10 watt amplifier (push-pull 6V6's) on separate chassis. All you need is a record changer and speaker to have a complete home music system. 3 ft. cable connects tuner to amp. Tuner has input for crystal phono. (If changer with v.r. cartridge is purchased, we will include the necessary pre-amp, no charge.) Tuner has 6 tubes: 12AT7, 6BE6, 2-6BA6, 6AT6, 6AL5 and 6X4 rectifier. Amp has 2-6V6's, 6SN7 and rectifier. Full superhet circuit with AVC, 3 position tone control, 3" illuminated slide rule dial, esctuechon and knobs. Stick loop antenna for AM. Radio-FM-AM, phono selector switch, tone control, volume control on tuner. Response 50 to 17,500 cps. Receives broadcast \$40 to 600 kc and FM 88 to 108 mc. Output matches any of the speakers shown above. No. FA9-2CR tuner and amplifier complete. Ship. wt. 22 lbs. Sale price, \$44.95. CU-14Y 12" coax speaker, \$10.00 extra; 15" coax speaker, \$20.00 extra.

WEBCOR 3 SPEED CHANGER
Model 140-16 WITH 2 NEEDLE FLIPOVER CARTRIDGE \$24⁹⁵

New Model 140-16, Webster-Chicago 3 speed automatic record changer with Astatic 66-TMY, 2 needle flipover crystal cartridge. Plays all 3 speeds and all 3 size records, shuts off automatically after last record. Has neutral position to prevent damaging drive wheels when changer is not in use. 13 3/8" x 12" deep, 7 1/2" high, overall 2 1/2" below motor board and 4 1/2" above. Model 140-16. Ship. wt. 12 lbs. Sales price, \$24.95.



MINIATURE BROADCASTING STATION FOR MICROPHONE AND PHONO WITH CRYSTAL MICROPHONE
SALE PRICE \$9.95

Sensational new model MCL-E3 miniature broadcasting station for microphone and phono. Can be received on any broadcast radio in the home. No wires to connect, tunes in just like a radio station. Has input jacks for crystal mike or record player. Complete with 12K8 and 70L7 tubes and instructions. Operates on 110 volts AC. Simple to operate, one control for microphone to record. Frequency can be adjusted so as not to interfere with local radio stations. Miniature broadcasting station, complete with crystal hand mike and instructions. Ship. wt. 4 lbs. Net price \$9.95.

9-TUBE HI-FIDELITY
12 Watts Audio Dual Tone Controls \$39⁹⁵
 RECEIVES BROADCAST 550 TO 1650 K.C.

Jackson AM9A, 12 watt hi-fi audio amplifier and broadcast tuner combined. Less than you would pay for the amp alone. Push-pull 6V6's. Response 30 to 15,000 cps. Inputs for crystal or v.r. phono and crystal or dynamic mike. Separate bass boost and treble tone controls, radio-phonograph switch. Shielded output matches 3.2 or 8 ohm speaker. Heavy duty 150 mil power trans. 9 1/2" illuminated slide rule dial. 3 gang condenser with tuned R.F. and loop ant. Receives 550 to 1650 kc. Size, 13" x 9 1/2" x 6" high. With tubes: 2-6BA6, 6AU6, 6BE6, 6SN7, 6AT6, 2-6V6 and 5Y3. Knobs, esctuechon, diagram and instructions included. Model AM9A. Ship. wt. 19 lbs. Sale price, \$39.95. CU-14Y 12" coax speaker, \$10.00 extra; 15" coax speaker, \$20.00 extra.

NEW—SMALL VOLT-OHM METER
2000 OHMS PER VOLT AC-DC WITH TEST LEADS
2 FOR \$19.50—4 FOR \$37.00

New, small Volt-Ohm meter 5 1/4" tall, 3 5/8" wide and 1 1/2" thick, 3/4" meter. Sensitivity 2000 ohms per volt. DC volts 0 to 1000 in 5 ranges; AC volts 0 to 1000 in 5 ranges; DC current 0 to 500 ma. in 3 ranges; Resistance 0 to 1.5 megohms in 2 ranges; Decibels minus 20 to plus 16 (Odb 774 volts). A thin, compact instrument small enough to fit in your service kit. A fine imported meter specially priced at \$9.95 for this Radio & TV News ad. Never before have we offered an instrument value like this. Model TP-5, complete with test leads. Sale price, only \$9.95. Ship. wt. 2 lbs. Special quantity price, 2 for \$19.50, or buy 4 for only \$37.00.
 New, larger size Volt-ohm meter Model MT-1A, 6 1/4" tall, 4 1/4" wide and 2 5/8" thick. 2000 ohms per volt. Similar in appearance to Model TP-5, except that it is larger. Has 3 1/2" meter and 4 resistance ranges instead of 2. Model MT-1A. Ship. wt. 2 lbs. Sale price, \$12.95 each, 2 for \$25.00.

NEW 6-TUBE, 12-VOLT UNIVERSAL MOUNTING

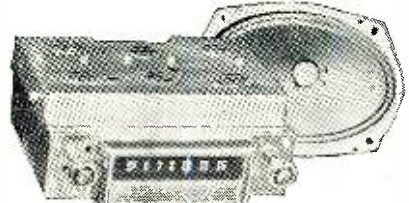

AUTO RADIO WITH 5" x 7" OR 6" x 9" SPEAKER
SALE PRICE \$29⁹⁵
6-TUBE, 6-VOLT WITH \$19⁹⁵ SPEAKER

McGee makes another tremendous purchase and passes the saving on to you. This universal mounting, 6 tube, 6 volt auto radio is a full superhet with fully tuned R.F. stage. Made to sell at a much higher price, by one of America's best known manufacturers. Its very thin and compact construction lends it to a neat underdash installation in most any car or truck. Or, you can arrange a place in the dash for custom installation. (Dial requires a cut-out 5 1/2" long x 2 1/2" high; two control holes on 7" centers. A minimum of 6 3/4" depth behind dash.) When mounted underdash it extends only 2 1/2" below. Overall sizes: 9" wide, 4 1/4" high and 7 1/4" deep. Requires no more room under your dash than an ordinary auto radio remote control head. Not intended for an exact custom panel fit, but it lends itself very well for your custom installation ideas. Can be custom fit in most late model cars and trucks. Has no built-in speaker, but is furnished with a heavy duty 6x9" speaker. This is the most popular size auto radio speaker. Tubes: 6BE6, 2-6BD6, 6AV6, 6A05 and 6X4. Ship. wt. 12 lbs. Stock No. AH-759. McGee's sale price, \$19.99 for the radio complete with 6x9" speaker, 3 section top cowl antenna, \$2.29 extra.

NEW 12-VOLT MODEL WITH SPEAKER \$29.99
 Model AH-1259, 12 volt universal mounting auto radio. This is the same set as pictured above (AH-759), except made for 12 volt model 1955 and 1956 cars. Stock No. AH-1259 with 6x9" or 5x7" speaker, \$29.99. Stock No. RP-232X, 6x9" rear seat speaker kit for 12 volt cars, \$4.99 extra.

McGEE RADIO COMPANY PRICES F.O.B. KANSAS CITY TELEPHONE VICTOR 5092
 SEND 25% OR FULL REMITTANCE WITH ORDER. 1903 MCGEE ST., KANSAS CITY, MISSOURI
 BAL. SENT C.O.D.

SUPREME MODELS 600 & 616

2V3G	50	E	2	4	7
3BY6	56	B	3	5	24
3CF6	56	B	3	5	24
6AU8	23	C	4	7	15
6AU8	19	C	4	7	56
6AW8	19	C	4	7	15
6AW8	16	C	4	7	56
6AX8	56	B	4	7	57
6AX8	47	B	4	7	58
6AZ8	56	B	4	7	35
6AZ8	47	B	4	7	57
6BA8	56	B	4	7	56
6BA8	47	B	4	7	15
6BC4	20	C	4	7	56
6BC8	58	B	4	7	35
6BC8	58	B	4	7	58
6BH8	56	B	4	7	56
6BH8	47	B	4	7	15
6BJ7	54	B	4	7	15
6BJ7	54	B	4	7	57
6BJ7	54	B	4	7	59
6BK4	99	B	2	7	17
6BL4	21	C	7	7	38
6BY6	56	B	3	7	24
6CB5(134568)	19	C	2	7	367
6CG7	23	C	4	7	35
6CG7	23	C	4	7	58
6DE6	19	C	3	7	24
12BA7(45)	30	C	9	7	345
12BA7(dio)	85	B	9	7	4578
12BA7(dio)	85	B	9	7	4568
12AV5GA	21	C	2	9	37
12BV7(459)	18	C	6	7	145
12C5	18	C	3	9	14
12CS6	56	B	3	9	24
19AU4	23	C	7	10	38
25A5	23	C	2	11	37
25C6	20	C	2	11	78
25CA5(25)	19	C	3	11	14
25CD6GB	19	C	2	11	37
1625	20	A	1	9	67
1626	26	C	2	9	78
1629	90	D	2	9	78
5608A	30	C	1	4	347
5608A	30	C	1	4	457
5686(13689)	19	C	4	7	1358
5687(45)	19	C	8	7	345
5687	19	C	8	7	456
5763(89)	20	C	4	7	57
5812(34)	23	C	7	7	34

SUPREME MODELS 589, 599 & 504-A, B

2V3G	2	3	60	E	7
3BY6	3	4	56	B	24
3CF6	3	4	56	B	24
6AU8	4	6	23	C	15
6AU8	4	6	19	C	56
6AW8(a4X8)	4	6	19	C	15
6AW8	4	6	16	C	56
6AX8(a4X1)	4	6	56	B	57
6AX8	4	6	47	B	58
6AZ8(a4X8)	4	6	56	B	35
6AZ8	4	6	47	B	57
6BA8(a4X8)	4	6	56	B	56
6BA8	4	6	47	B	15
6BC4	4	6	20	C	56
6BC8	4	6	58	B	35
6BC8	4	6	58	B	58
6BH8(a4X8)	4	6	56	B	56
6BH8	4	6	47	B	15
6BJ7(a4X3)	4	6	54	B	35
6BJ7	4	6	54	B	15
6BJ7	4	6	54	B	57
6BK4	2	6	99	B	17
6BL4	7	6	21	C	38
6BY6	3	6	56	B	24
6CB5(134568)	2	6	19	C	367
6CG7	4	6	23	C	35
6CG7	4	6	23	C	58
6DE6	3	6	19	C	24
12BR7	4	8	30	C	35
12BR7(dio)	4	8	85	B	578
12BR7(dio)	4	8	85	B	568
12AV5GA	2	8	21	C	37
12BV7(45)	6	6	18	C	145
12C5	3	8	18	C	14
12CS6	3	8	56	B	24
25AV5GA	2	9	23	C	37
25C6GA	2	9	20	C	78
25CA5(25)	3	9	19	C	14
25CD6GB	2	9	19	C	37
1625	1	8	20	A	67
1626	1	8	26	C	78
1629	2	6	90	D	78
5608A	1	3	30	C	347
5608A	1	3	30	C	457
5686(138)	4	6	19	C	1358
5687(a4X1)(45)	8	6	19	C	456
5687	8	6	19	C	456
5763	4	6	20	C	57
5812(34)	7	6	23	C	34
6146(146)	2	6	21	C	1467

New Tube Tester Data

HERE again, as in previous issues, is information you need to bring your tube tester up-to-date. The settings listed here are for tubes which have recently been made available.

Supreme Incorporated, Greenwood, Miss., The Triplett Electrical Instrument Co., of Bluffton, Ohio, and Precision Apparatus Company, Inc., 70-31 84 St., Glendale, L. I., N. Y., all have revised roll charts available at nominal cost for their customers. Of particular interest

is the new subscription plan just announced by Precision for tube tester data. According to this plan, the subscriber receives a minimum of two new roll charts plus other supplementary data for a full year's subscription of \$2. Subscribers must furnish the model and serial numbers of their Precision testers and the form number of the roll charts now in their Precision tube testers.

Data on other tube testers will be listed next month.

-30-

PRECISION APPARATUS COMPANY, INC., MODELS 10-12, 10-15, etc.

TUBE	SECTION	A	B	C	D	E	W	LEVER			FIL. CONT.
								X	Y	Z	
4BS8	Triode-1	5	4	9	12	6	-	-	6	7	4-5
4BS8	Triode-2	5	4	9	12	6	-	-	1	2	-
5AS4	Plate-1	2	2	0	5	6	-	-	4	-	2-8
5AS4	Plate-2	2	2	0	5	6	-	-	6	-	-
5AS8	Pentode	1	4	15	20	6	-	1	9	2	4-5
5AS8	Diode	3	4	0	17	6	-	-	6	-	-
5BT8	Pentode	1	4	5	33	6	-	7	6	8	4-5
5BT8	Diode-1	3	4	0	20	6	-	-	2	-	-
5BT8	Diode-2	3	4	0	20	6	-	-	1	-	-
6BS8	Triode-1	5	4	9	12	7	-	-	6	7	4-5
6BS8	Triode-2	5	4	9	12	7	-	-	1	2	-
6BT8	Pentode	1	4	5	33	7	-	7	6	8	4-5
6BT8	Diode-1	3	4	0	20	7	-	-	2	-	-
6BT8	Diode-2	3	4	0	20	7	-	-	1	-	-
6CB5		1	2	5	6	7	1-4	8	11	5	2-7
(6CB5—Must show short on 1-3-4-5-6-8; Grid short test—depress 4-5 together)											
(6CB5—Screen short test—depress 1-8 together, Cathode short test—depress 3-6 together)											
6CS7	Triode-1	1	4	25	9	7	-	1	3	4-5	-
6CS7	Triode-2	1	4	23	14	7	-	-	6	7	-
6DN6		1	2	0	6	7	-	8	11	5	2-7
6DQ6		1	2	8	4	7	-	4	11	5	2-7
12AB5		1	4	10	19	10	1-3	8	9	6	4-5
(12AB5—Must show short on 1-3-6-8; Grid short test—depress 3-6 together)											
(12AB5—Screen short test—depress 1-8 together)											
12AD7	Triode-1	1	9	8	38	7	-	-	6	7	4-5-9
12AD7	Triode-2	1	9	8	38	7	-	-	1	2	-
12DN6		1	2	0	6	10	-	8	11	5	2-7
12DQ6		1	2	8	4	10	-	4	11	5	2-7
25DQ6		1	2	8	4	12	-	4	11	5	2-7
50BK5		1	4	17	11	14	3	8	1	7	4-5
(50BK5—Fil. Cont.—Set control "E" at 12)											
(50BK5—Must show short on 3-7)											
(50BK5—Grid short test—depress 3-7 together)											
6046		1	2	10	6	12	-	4	3	5	2-7
6096		1	3	22	16	7	-	6	5	1	3-4
(6096—Must show short on 2-7)											
(6096—Cathode short test—depress 2-7 together)											
6394	Triode-1	1	7	15	4	12	-	-	5	4	7-8
6394	Triode-2	1	7	15	4	12	-	-	2	1	-
6660		1	3	28	15	7	-	6	5	1	3-4
6661		1	3	26	20	7	-	6	5	1	3-4
6662		1	3	17	20	7	-	6	5	1	3-4
6663	Diode-1	3	3	0	17	7	-	-	7	-	3-4
6663	Diode-2	3	3	0	17	7	-	-	2	-	-

TRIPLETT MODEL 3413-A & 3413-B

TUBE TYPE	A	KNOBS		C	LEVER POSITION	
		B			UP	DOWN
12C5	3		12.6	17	2567	13
25CD6GA	3		25	16	580	23
5636 (Adapt BW)	1		6.3	19	1457	238
(Levers 2 and 8 moved up together will not show short.)						
5718 (Adapt BW)	1		6.3	19	18	35
5896 (Adapt BW)	1		6.3	20	1	23
5896 Test 2	1		6.3	20	5	37
5902 (Adapt BW)	2		6.3	22	157	2348
(Levers 2, 3 & 8 moved up together will not show short.)						
6012	4		6.3	18	358	12
6021 (Adapt BW)	1		6.3	19	12	34
6021 Test 2	1		6.3	19	78	35
*3CF6†	2		3.15	20	1567	24
(No open element test on levers 5 & 7)						
*6BC8	1		6.3	19	67	48
*6BC8 Test 2	1		6.3	19	12	34
*6CN7††	0		3.15	63	78	456
*6CN7 Test 2	3		3.15	20	1	345
*6CN7 Test 3	3		3.15	20	2	345
*6CR6	1		6.3	23	567	14
*6CR6 Test 2	1		6.3	36	2	14
*6DE6	2		6.3	20	1567	23
(No open element test on pin 5)						
*6DG6 (††)	3		6.3	63	34	1578
*5642	1		1.4	80	7	1
((Good tube reads 40) (Insert filament in 1 & 7 of subminiature socket)						
*5643 (Adapt BW)	2		6.3	28	2478	56
(No open element tests on pins 2, 4, 8)						
*5824	3		25	18	345	178
*6110 (Adapt BW)	1		6.3	22	5	67
*6110 Test 2	1		6.3	22	1	26

†For 3413-A use adapter BX and set filament voltage to 5.

††For 3413-A use adapter BZ and set filament voltage to 5.

*For special short tests on tubes with internal connections refer to instruction book.

ALLIED knight-kits

FINEST ELECTRONIC EQUIPMENT IN LOW-COST KIT FORM

YOU SAVE MORE BECAUSE YOU BUY DIRECT

LOW COST—huge buying power and DIRECT SALE pass biggest savings on to you. You do the easy assembly and your built-up instrument is equal in appearance and performance to equipment selling for several times the KNIGHT-KIT price.

ADVANCED DESIGN—months of research, development and field testing go into each KNIGHT-KIT. And to assure top performance, premium quality parts are supplied throughout.

EASIEST ASSEMBLY—all chassis and panels are punched for accurate assembly; all parts are fully identified. Instruction manuals are a marvel of simplicity and clarity, featuring "Step-and-Chek" assembly, "King-Size" diagrams and "Spotlight" pictorials. For easy assembly you need only a soldering iron, pliers and screwdriver.

ALLIED—the reliable name in Electronics—gives you the greatest value in KNIGHT-KITS through the economies of DIRECT SELLING



**PRINTED
CIRCUITS**

Model F-144
\$69⁰⁰

knight-kit WIDE-BAND 5" OSCILLOSCOPE KIT

\$6.90 down,
12 months to
pay balance

Wide-band 5" Oscilloscope equal or superior to commercially-wired 'scopes costing several times the price. Vertical response from 5 cycles to 5 mc—ideal for the professional laboratory, for color TV servicing, and high frequency applications. Response —1 db at 3.58 mc; —3 db at 5 mc. Two printed circuit boards and laced wiring harness reduce assembly time. Has very wide sweep range—from 15 to 600,000 cps. Locks in frequencies as high as 9 mc. High vertical sensitivity of 25 rms millivolts/inch. Input capacitance 36 mmf. Outstanding features: cathode-follower vertical and horizontal inputs; 1400 volts at 2nd anode provides high-intensity trace; push-pull vertical and horizontal amplifiers; positive and negative locking; faithful square wave response; frequency-compensated input attenuator; Z-axis input for intensity modulation; one volt peak-to-peak calibrating voltage; internal astigmatism control; blanking circuit to eliminate retrace lines; DC positioning control. Complete with all tubes and parts, ready for easy assembly. Handsome professional case finished in blue, with gray control panel. Shpg. wt., 40 lbs.

Model F-144. 5" Oscilloscope Kit. Net only..... **\$69.00**
Model F-148. Demodulator Probe. Net..... **\$3.45**
Model F-147. Low Capacity Probe. 12 mmf. Net..... **\$3.45**

ALSO AVAILABLE: Refer to your 324-page 1956 Allied Catalog for dozens of other KNIGHT-KIT values, including 20,000 Ohms/Volt VOM, Signal Generator, Audio Generator, Resistor-Capacitor Tester, Signal Tracer, Resistance and Capacitance Substitution Boxes. Additional test instrument kits appear on the next page, followed by famous Hobbyist, Ham and Hi-Fi KNIGHT-KITS.



knight-kit PRINTED CIRCUIT VTVM KIT

Model F-125 New, extremely stable, highly accurate VTVM. Greatly simplified wiring—entire chassis is a printed circuit board. Features maximum convenience in arrangement of scales and controls.

\$24⁹⁵

With peak-to-peak scale for FM and TV work. Ranges: AC peak-to-peak volts, 0-4-14-40-140-400-1400-4000; AC rms volts and DC volts, 0-1.5-5-15-50-150-500-1500; ohms, 0-1000, 10K, 100K; 1-10-100-1000 meg; db scale, —10 to +5. Response, 30 cps to 3 mc. Uses low-leakage switches and 1% precision resistors. Balanced-bridge, push-pull circuit permits switching to any range without adjusting zero set. 4 1/2" meter, 200 microamp movement. Polarity reversing switch. Input resistance, 11 meg. Complete kit, ready to assemble. Shpg. wt., 6 lbs.

Model F-125. Printed Circuit VTVM Kit. Net only..... **\$24.95**

Model F-126. Hi-Voltage Probe; extends DC range to 50,000 Volts. Net..... **\$4.75**

Model F-127. Hi-Frequency Probe; extends AC range to 250 mc. Net..... **\$3.45**

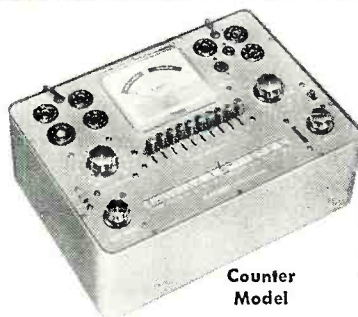

Counter
Model

knight-kit TUBE TESTER KIT

An Outstanding Value

Model F-143

\$29⁷⁵

Portable
Model

Expertly designed, up-to-date, ideal for the laboratory or service shop. Remarkably low priced, yet it offers high accuracy, top versatility and convenience. Illuminated roll chart lists over 700 tube types. Features provision for testing 600-ma tubes; roll-chart includes data for all popular series-string types. Tests 4, 5, 6 and 7-pin large, regular and miniature types, octals, loctals, 9-pin miniatures and pilot lamps. Tests for open, short, leakage, heater continuity and quality (by amount of cathode emission). 4 1/2" square meter with clear "GOOD—?—REPLACE" scale. With line-voltage indicator and line-adjust control. Choice of 14 filament voltages from .63 to 117 volts. Blank socket for future type tubes. Universal-type selector switches for any combination of pin connections. Single-unit, 10-lever function switch simplifies assembly. Complete kit, ready for easy assembly. Shpg. wt., 14 lbs.

Model F-143. Counter Model Tube Tester Kit. Net only. **\$29.75**
Model F-142. As above, but with carrying case. Net only... **\$34.75**
Model F-141. TV Picture Tube Adapter for above. Net only. **\$3.75**

EASY PAYMENT TERMS: If your total kit order comes to over \$45, take advantage of our liberal Time Payment Plan—only 10% down, 12 full months to pay. Write for application form.

Order from

ALLIED RADIO
100 N. WESTERN AVÉ., CHICAGO 80, ILLINOIS

SEE FOLLOWING PAGES

ALLIED knight-kits...Top Quality

knight-kit IN-CIRCUIT CAPACITOR CHECKER KIT



SAVE UP TO 70%

Model F-119

\$11.65

SUPER-VALUE

Tests capacitors while they are still wired in the circuit! Saves time and trouble. Just press a button and the "magic eye" instantly shows opens and shorts. Checks practically any bypass, blocking, coupling and filter capacitors for opens or shorts. Tests for opens can be made on any capacitor of 20 mmf or greater, even when capacitor is in parallel with resistance as low as 50 ohms. Tests for opens on any capacitor up to 2000 mfd, even when shunted by as low as 20 ohms. Housed in professionally styled case, sturdy steel in blue wrinkle finish with gray control panel. Complete kit, ready for easy assembly. Shpg. wt., 5 lbs.

Model F-119. Capacitor Checker Kit. Net only **\$11.65**



knight-kit VOM KIT

1000 Ohms/Volt

Model F-128

\$14.25

Exceptional accuracy and versatility at amazing low cost. Ideal for service shop, lab and Amateur use. Uses 4 1/2" meter (400 microamp movement) with separate scales for AC voltage and current, DC voltage and current, decibels and resistance. 38 ranges include: AC, DC and Output volts, 0-1-5-10-50-100-500-5000 (1000 ohms/volt sensitivity); Resistance, 0-1000-100,000 ohms and 0-1 meg.; Current, AC or DC, 0-1-10-100 ma and 0-1 amps; Decibels, -20 to +69 in 6 ranges. Uses 1% precision resistors. 3-position function switch and 12-position range switch. Complete kit with bakelite case, battery and test leads. Shpg. wt., 2 1/2 lbs.

Model F-128. 1,000 ohms/volt VOM Kit. Net only **\$14.25**

EASY PAYMENT TERMS:

If your total kit order comes to over \$45, take advantage of our liberal Time Payment Plan—only 10% down, 12 full months to pay. Write for application form.

BUY WITH CONFIDENCE • BUILD WITH CONFIDENCE

- Advanced Electronic Design
- Precision Quality Performance
- Professional Streamlined Styling
- Premium Quality Components
- Crystal-Clear Instruction Manuals
- "Step-and-Chek" Building Method

BUY DIRECT • YOU SAVE MORE • YOU GET MORE FOR YOUR KIT DOLLAR

FAMOUS knight-kits FOR HOBBYISTS

"SPACE-SPANNER" RECEIVER KIT



Model S-243 Featuring Bandswitching for Thrilling Short Wave and Broadcast Reception. All-new 2-band receiver—easy to build—a great value! Pulls in thrilling short wave including amateur, aircraft, police and marine radio (6 to 17 mc), and standard broadcast. Features special highly sensitive regenerative circuit. Has 4" PM speaker and beam-power output tube for plenty of volume. Kit includes calibrated panel, punched chassis, all parts and tubes, detailed instructions (less wire and solder). 7 x 10 1/2 x 6"; for 110-120 v. 50-60 cycles AC or DC. Shpg. wt., 4 1/2 lbs.

Model S-243. "Space-Spanner" Kit. Net Only (less cabinet) **\$13.95**
S-247. Matching cabinet for above **\$2.85**

GEIGER COUNTER KIT

Super-sensitive Uranium Locator and Radio-activity Detector. Get started in uranium prospecting now with this extremely sensitive instrument—comparable to costly equipment, yet easy to build at only a fraction of the price. Just turn it on, flip the high-voltage switch and listen to the clicks in the headphone when you hit a radioactive source. Uses low-cost long-life batteries. Kit includes all parts, tubes, carrying case with shoulder strap, 22 1/2 and 1 1/2 v. batteries, headphone, AEC prospecting booklet, radioactive sample and complete assembly instructions. Shpg. wt., 2 1/2 lbs.

Model S-242

\$15.95

Model S-242. Geiger Counter Kit. Net only **\$15.95**



FAMOUS 10-IN-1 LAB KIT

Model S-265 Build Any One of 10 Fascinating Projects. Instructive and fun to build. Construct a sensitive Broadcast Receiver; Amplifier (for phono or mike); Wireless Phono Oscillator; Home "Broadcast Station"; Code Practice Oscillator; Capacity-Operated Relay or any one of four other fascinating projects. Kit includes mounting board, special "safety designed" low voltage power transformer, tubes, all parts, microphone, 12-page builder's manual (less wire and solder). For 110-120 v. 50-60 cycles AC. Shpg. wt., 10 lbs.

Model S-265. "10-in-1" Kit. Net only **\$12.45**

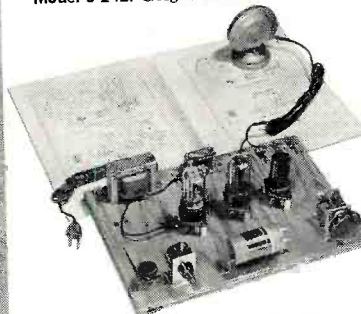

PORTABLE RADIO KIT

Powerful 3-Way Operation. Top-quality, portable AM receiver for AC, DC or battery operation. Tunes full broadcast band, 535-1650 kc. Features sensitive superhetrocircuit; 5" PM dynamic speaker; built-in loop-stick antenna; automatic volume control; handsome carrying case. Complete with all parts, tubes and easy-to-follow instructions (less wire, solder and batteries). For 110-120 v., 50-60 cycle AC, DC, or batteries. Shpg. wt., 6 lbs.

Model S-730

\$18.75

Model S-730. Portable Radio Kit. Net only **\$18.75**
S-651. Battery Kit for above. Net **\$2.40**



TRANSISTOR RADIO KIT

Printed Wiring—Works From Flashlight Cell. Experiment with the marvel of transistors in this printed-circuit radio. No tubes—no crystal! Small enough to fit in the palm of the hand—yet it provides powerful reception over the complete AM broadcast band. Operates from single flashlight cell. For use with headphones. Printed circuit eliminates wiring—just assemble and solder a few connections! Supplied complete with all parts, hardware, battery, and easy-to-follow instructions. Less solder, antenna and headphone. Shpg. wt., 8 oz.

Model S-765. Transistor Radio Kit. Net only **\$3.95**



Model S-765

\$3.95

RECEIVER KIT ACCESSORIES

J-149. 4000 ohm extra-sensitive double headset. Net **\$1.98**
C-100. Antenna kit for use with all Knight-Kit receivers. Net **\$1.05**

All Prices Net F.O.B. Chicago

Order from **ALLIED RADIO** 100 N. WESTERN AVE., CHICAGO 80, ILL.

Easiest-to-Build Electronic Equipment in Kit Form

**BUY DIRECT
AND SAVE!**

LOW-COST HAM GEAR



**knight-kit
50 WATT CW TRANSMITTER KIT**

Model SX-255
\$42⁵⁰
Built-in Pi-Type Antenna Coupler
 Check the features packed into this new transmitter kit and you'll see why it's one of the greatest Amateur values ever offered. Compact and versatile, it is the perfect low-power rig for the beginning Novice or seasoned veteran. Features: 50 watts input to 807 final; high-efficiency 6AG7 modified-Pierce oscillator takes crystal or VFO without circuit changes; bandswitching coverage of 80, 40, 20, 15, 11-10 meters; pi-section antenna output matches line impedances from 50 to 1200 ohms—permits use with any type of antenna. Crisp, clean, cathode keying of oscillator and final. Power take-off plug supplies filament and B-plus voltages for other equipment. Copper-finished chassis and cabinet interior, filtering, shielding, bypassing, and coaxial SO-239 antenna connector provide excellent TVI suppression. Meter reads either plate or grid current of final. Jacks for VFO, crystal, and key. Supplied with all parts, tubes and step-by-step instructions. Less crystal and key. Size, 8¹/₁₆ x 11¹/₁₆ x 8³/₄". For 110-120 volts, 50-60 cycle AC. Shpg. wt., 18 lbs.
SX-255. 50-Watt Transmitter Kit. Net \$42.50



**knight-kit
SELF-POWERED
VFO KIT**

Model S-725
\$27⁵⁰

Complete with built-in power supply! Careful design and voltage regulation assure high stability. Excellent oscillator keying characteristic for fast break-in without clicks or chirps. Full TVI suppression. Has plenty of bandspread: separate calibrated scales for 80, 40, 20, 15, 11 and 10 meters; vernier drive mechanism. 2-chassis construction keeps heat from frequency determining circuits. Output cable plugs into crystal socket of transmitter. Output on 80 and 40 meters. With Spot-Off-Transmit switch for "no swish" tuning. Extra switch contacts for operating relays and other equipment. Complete kit for easy assembly.
 Shpg. wt., 8 lbs.
Model S-725. Self-Powered VFO Kit. Net \$27.50



**knight-kit
CODE PRACTICE
OSCILLATOR KIT**

Model S-239
\$4⁹⁵ Transistorized—
 Powered by Flash-
 light Battery

An ideal new code practice oscillator. Uses transistor circuit. Extremely low current consumption—powered by single penlight battery. Provides crisp, clear tone (400 to 600 cps). Has input jack for earphone; screw-type terminal strip for key. In compact bakelite case (2³/₈ x 3³/₄ x 1¹/₂" with anodized aluminum panel. Complete with all parts, battery and easy-to-follow instructions. Shpg. wt., 1 lb.
Model S-239. Code Practice Oscillator Kit \$4.95

BUILD-YOUR-OWN HIGH FIDELITY knight-kits

**knight-kit
BASIC 25-WATT
LINEAR-DELUXE
HI-FI AMPLIFIER KIT**

Model S-755
\$41⁵⁰

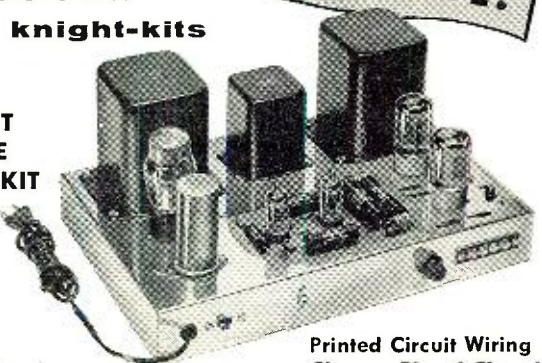

**Custom Quality
Williamson-type Circuit**

**Printed Circuit Wiring
Chrome-Plated Chassis**

Designed to satisfy the most critical listener. Intended for use with tuners incorporating built-in preamp or with separate preamp. Uses latest Williamson-type circuit. Has potted, matched transformers. Output: Maximum, 45 watts; rated, 25 watts. Frequency response: ± 0.5 db, 10 to 120,000 cps, measured at 20 watts. Harmonic distortion is only 0.15% right up to 30 watts. Intermodulation is only 0.27% at 17 watts and only 1% at 20 watts, using 60 cps and 7 kc, 1:4 ratio. Hum level is 85 db below rated output. Output impedance, 4, 8, 16 ohms. Uses two 12AU7's, two 5881's, and a 5V4. Printed circuit is utilized in voltage amplifier and phase inverter stages. Has output tube balancing control, variable damping control, and on-off switch. Handsome chrome-plated chassis, 14" x 9" x 2". Overall height, 7". Complete with all parts, tubes and construction manual (less wire and solder). Shpg. wt., 27 lbs.
Model S-755. Basic 25 watt Hi-Fi Linear-Deluxe Amplifier Kit. Net \$41.50
Model S-706. Knight Preamplifier-Equalizer. Ideal for use with above amplifier. Provides 5 selectable inputs. Completely wired—ready to use. Net \$36.95



**knight-kit
10-WATT HI-FI AMPLIFIER KIT**

Model S-234
\$20⁹⁵
 Famous for wide response and smooth reproduction at low cost. Only 0.5 volt drives amplifier to full output. Response: ± 1 db, 30-20,000 cps at 10 watts. Harmonic distortion less than 0.5% at 10 watts. Intermodulation is less than 1.5% at full output. Controls: On-off-volume, bass, treble. Input for crystal phono or tuner. Chassis punched to take preamp kit for magnetic cartridges. Matches 8 ohm speakers. Shpg. wt., 14 lbs. Complete kit (less wire and solder).
Model S-234. Amplifier Kit. Net. \$20.95
Model S-235. Preamp Kit for above. Net. \$2.75

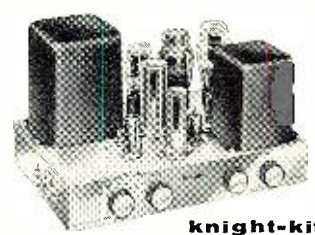

**knight-kit
20-WATT HI-FI AMPLIFIER KIT**

Model S-750
\$34⁷⁵
 True hi-fi for less! Response, ± 1 db, 20 to 20,000 cps at 20 watts. Distortion, 1% at 20 watts. Hum and noise level: Tuner input, 90 db below 20 watts; magnetic phono, 72 db below 20 watts. Sensitivity: Tuner input, 0.6 volt for 20 watts output; magnetic phono, .007 volts. 4 inputs: Magnetic phono, microphone, crystal phono or recorder, and tuner. Controls: Bass, Treble, Volume, Selector with compensation positions for 78 and LP records. Chrome-plated chassis. Wt., 23 lbs. Complete kit (less wire and solder).
Model S-750. 20-Watt Hi-Fi Amplifier Kit. Net. \$34.75

ALLIED RADIO

Everything in Electronics from One Reliable Source

**OUR
35TH
YEAR**

Allied Radio Corp., Dept. 1-C-6,
100 N. Western Ave., Chicago 80, Ill.

Ship me the following KNIGHT-KITS:

Quantity	Description	Model No.	Price

\$ enclosed. For parcel post include postage (express is shipped collect).

Send FREE 324-Page ALLIED Catalog listing the complete Knight-Kit line.

Name _____

Address _____

City _____ Zone _____ State _____

ORDER TODAY →

Have you had the
Chassis Touching
JITTERS
Lately?



Adjust-A-Volt

LR-5 VARIABLE TRANSFORMER

with isolated primary winding lets you service any TV or radio set made without a chance of a "bite" no more chassis touching jitters.



\$29.50

Delivery from stock of your favorite jobber.

This husky 1/2 KVA electro-statically shielded unit is "Must" test equipment for thousands of service men. Intermittent operating TV or radio sets are checked by dropping line voltage to 105 V or lower to detect a faulty oscillator. Also used to cook a set at 130-140 V to break down intermittent part. On any application where either isolation or a variable transformer is needed Adjust-A-Volt will do the job. Black wrinkle finish, jeweled pilot light and convenient fuse. Write for new 18-page catalog listing all types and sizes.

**STANDARD
ELECTRICAL PRODUCTS CO.**

2238 E. THIRD ST. • DAYTON, OHIO

A New FM Tuner



Over-all view of FM-3 tuner.
Cabinet measures 12-9/16" x 3 3/8" x 5 7/8".

Details on the latest addition to Heath's line of broadcast gear—a compact FM-3 88-108 mc. tuner.

IN RESPONSE to customer demand, Heath Company, Benton Harbor, Michigan has recently introduced an assemble-it-yourself FM tuner which retails for \$24.50 (with cabinet) as the FM-3.

The construction of this kit is simple but time-consuming. Your editors were fortunate in witnessing the assembly of the kit by a complete novice with no previous electronic experience. The construction details supplied with the kit were followed and the tuner worked on the first try.

The tuner covers the entire FM band from 88 to 108 mc. The circuit incorporates seven tubes. This is a ratio detector type of FM circuit which is simple and inexpensive to build and easy to align. This circuitry is capable of good performance and has the advantage of being self-AM limiting, eliminating the need for two limiter stages.

The only disadvantage of the ratio detector is that the audio output is dependent on signal strength to some extent.

It is for this reason that a volume control is used on the tuner. The a.g.c. voltage taken from the detector to the r.f. amplifier helps to even out the response to weak and strong signals so that variations are not very noticeable except in the case of extremely weak stations.

Sensitivity of the tuner is such that it will operate satisfactorily with an indoor antenna made of 300 ohm twin-lead if reasonable signal strength is prevalent in the area. For fringe performance, an outdoor antenna must be used.

Although all of the tuned circuits are pre-aligned, some adjustment may have to be made. An AM signal generator and a v.t.v.m. can be used successfully; however, it would be advisable to use an FM sweep generator and scope if such equipment is available. If this type of test equipment is not accessible, your local radio service shop will undoubtedly perform the final alignment job for you at a nominal cost.

Complete schematic diagram of the Heath FM-3 tuner which comes in kit form.

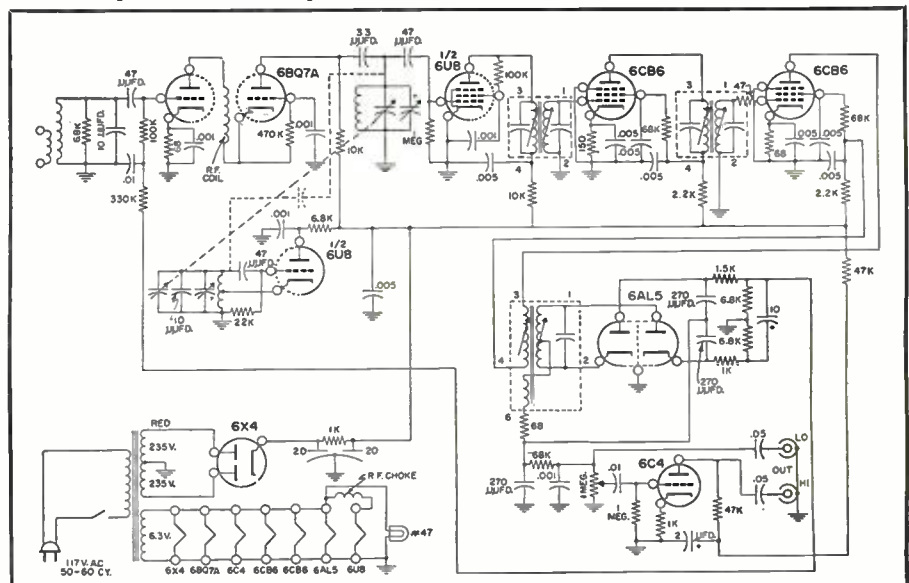

how long would it take you to solve this service problem?

SYMPTOM:

Loss of horizontal hold. Hold control will not pull the picture into synchronization. Sound is normal.

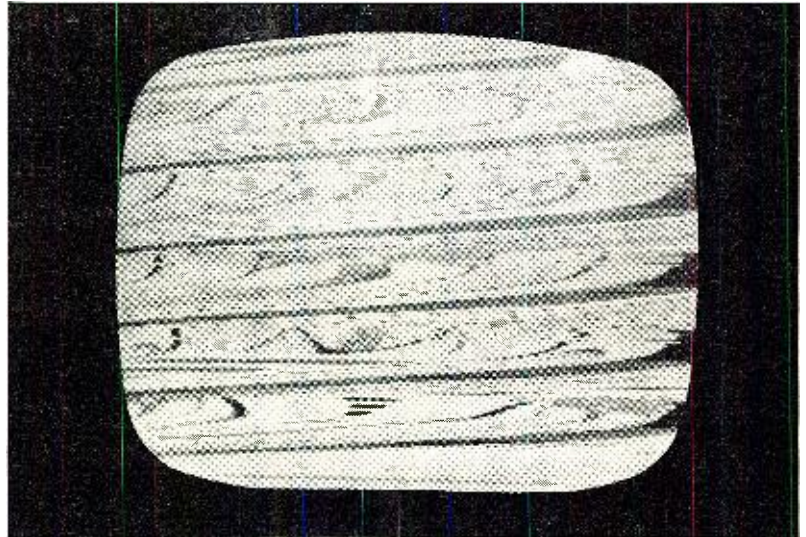

There's no telling how long it might take to solve this problem with hit-or-miss methods—it's been known to take hours. With a PHOTOFACT Folder by your side, the job takes just minutes. Here's why:

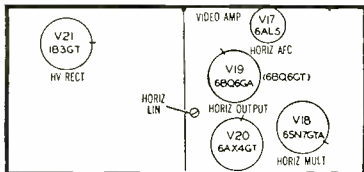

In just seconds, you locate the tubes most likely to cause this symptom by referring to the Tube Placement Chart* and Tube Failure Check Chart* you'll always find in the same place in each PHOTOFACT Folder.

In this case the trouble wasn't caused by tube failure, so...

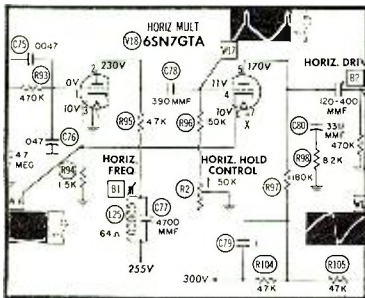

In just seconds you refer to the Horizontal Circuit on the Standard Notation Schematic* featured exclusively in all PHOTOFACT Folders. Circuits are always laid out in the same uniform manner. The Horizontal Circuit is always located in the lower center of the schematic. In a matter of minutes you check waveforms and voltages—they're right on the schematic. And in those same few minutes you find the answer to the problem in this case history. The waveform at W17 and the voltage reading at Pin 4 show a leaky coupling capacitor C78. Yes, you have your answer in just minutes!

C74	270	300	RCM20A271K	SI270	D6-270
C75	.0047	400	RCP10M4472M	SI4700	D6-470
C76	.047	200	RCP10M2473M	BPD-05	DF-50
C77	4700	500	47X543	1464-0047	
C78	390	500	RCM20B391J	1469-00039	D6-391
C79	.1	400	RCP10M4104M	P488N-1	DF-104
C80	330	500	47X570	1469-00033	D6-330

And PHOTOFACT, through its accurate Parts Listings*, instantly gives you a choice of the proper replacement required to accomplish the repair. You save even more time!

From start to finish, you solve your service problems in just minutes...you service more sets and earn more daily with PHOTOFACT by your side!

*One of 32 features found exclusively in PHOTOFACT—the world's finest service data



MONEY BACK GUARANTEE!

Got a tough repair? Try this—at Howard W. Sams' own risk: see your Parts Distributor and buy the proper PHOTOFACT Folder Set covering the receiver. Then use it on the actual repair. If PHOTOFACT doesn't save you time, doesn't make the job easier and more profitable for you, Howard W. Sams wants you to return the complete Folder Set direct to him and he'll refund your purchase price promptly. **GET THE PROOF FOR YOURSELF—TRY PHOTOFACT NOW!**

free

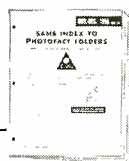

Send for Sams' INDEX TO PHOTOFACT FOLDERS—your guide to virtually any receiver model ever to come into your shop; helps you locate the proper PHOTOFACT Folder you need to solve any service problem on any model. You'll want this valuable reference guide. Send coupon now.

HOWARD W. SAMS & CO., INC.

Howard W. Sams & Co., Inc.
2203 E. 46th St., Indianapolis 5, Ind.

Send FREE Index to PHOTOFACT Folders
 I am a Service Technician

Name _____

Address _____

City _____ Zone _____ State _____

Horizontal Sweep

Questions & Answers

By **JESSE DINES***
Ram Electronics Sales Co.

You've probably run into at least one of the problems mentioned here; these answers may help avoid others.

IT SEEMS that the horizontal sweep system presents the technician with more service headaches than any other section of the TV receiver. Some of the most common problems pertaining to this system are stated in this article in the form of questions. The answers are based upon practical first-hand knowledge of most types of sweep systems.

Some of the questions deal with making circuit changes in the sweep system. Before any of these changes can be made, a milliammeter must be connected in series with the horizontal output tube cathode or, if this tube has a cathode resistor, then the voltage across it is measured and the current is calculated by using Ohm's Law. Circuit changes should result in a current change of not more than 10 to 15 percent, if horizontal output tube and/or flyback transformer damage is to be avoided. In the majority of cases, the normal current is less than 100 milliamperes.

Q—What procedure should be used to troubleshoot the flyback system?

A—(1) Try to pinpoint the trouble to the flyback system by raster or picture analysis. Certain defects such as "blooming," trapezoidal patterns, bow-tie pattern, "ringing," vertical line, and

excessive or insufficient raster width are often sweep troubles. Other troubles, such as no or dim raster, horizontal nonlinearity, and horizontal foldover, are usually found here. Still other faults, such as loss of horizontal and/or vertical sync and audio distortion, are found here in rare instances.

(2) If the sweep system is suspected, substitute a new horizontal oscillator, horizontal output, damper, or high-voltage rectifier tube. Very often, several (or all) tubes have to be replaced when an interrelated trouble exists, such as loss of boost voltage.

(3) See if overheating, smoking, arcing, or corona exists; check the associated component parts.

(4) Check for abnormalities by measuring all of the "B+", boost, bias, screen, cathode, and heater voltages. Also measure the horizontal output tube cathode current to see if it is excessive (generally, more than 100 milliamperes).

(5) Check for open windings in the flyback, yoke, and width-linearity inductive components. Note that a few shorted turns will not be indicated when using an ohmmeter. When an in-

ductive component is suspected of being shorted, use the substitution method to determine whether or not it is faulty.

(6) Use standard troubleshooting procedures to pinpoint the trouble.

Q—How may raster width be altered?

A—The following gives the methods used to increase raster width (refer to Fig. 1); in general, use the opposite procedure to decrease the width:

(1) Use a width coil with a higher inductance rating than that of the original; a larger inductance has more impedance, decreasing the power that the coil absorbs from the remainder of the flyback circuit. Connect the width coil across those taps of the flyback transformer secondary which have the fewest turns of wire (indicated by a d.c. resistance reading). Shunt the coil (or any other two taps of the flyback transformer secondary, such as those across which the yoke is connected) with a capacitor (C_4) which has a value of from .0001 to .002 μ fd. (1000-volts); the higher the capacitance value, the greater the picture width. Remove the width coil entirely to obtain excessive width.

(2) Increase the drive voltage to the horizontal output tube by doing the following: Reset the horizontal drive control C_2 . Increase the plate voltage to the horizontal oscillator tube by reducing the ohmic value of its plate load resistor, R_1 , and/or feeding the boost (instead of "B+") voltage to its plate. Increase the capacitance value of the wave-shaping capacitor in the plate circuit (if there is one). Increase the value of the coupling capacitor, C_1 , which connects the oscillator to the horizontal output tube.

(3) Reduce the horizontal output tube bias by decreasing or removing R_2 , the cathode resistor (if one exists). Increase the horizontal output tube screen voltage by reducing the value of the screen grid resistor, R_3 .

(4) Replace the low-voltage rectifier, high-voltage rectifier, and horizontal output tubes with ones which have a greater efficiency. Increase the "B+" voltage fed to the flyback system by reducing the value of the series dropping resistors in the "B+" line.

Q—How may the high-voltage output of the flyback system be altered?

A—Insufficient high voltage usually results in picture "blooming" (a picture with excessive height and width, accompanied by poor brightness and focusing). Excessive high-voltage results in a smaller but brighter picture and is usually accompanied by corona. The following indicates the methods used to increase the high voltage; in general, use the opposite procedures to decrease the high voltage.

(1) Insert a 500- μ fd. 20 kilovolt filter capacitor (if one is not already employed) from the high-voltage rectifier tube filament to ground. Still more high voltage can be obtained if the grounded side is connected instead to a "B+" point (such as the damper tube plate). The latter may also be

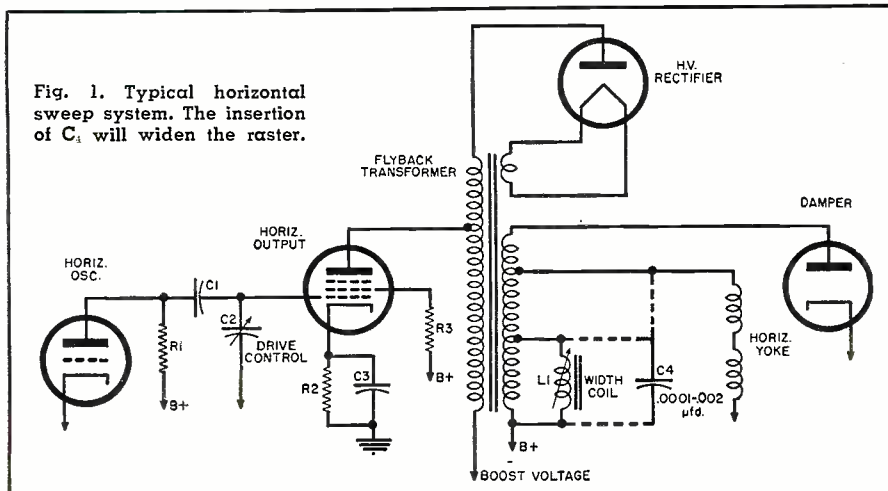

done to a filter capacitor if it is already in the circuit. Two 500- μ fd. filter capacitors may be used, separated by a series-dropping resistor of about 1 megohm, to increase the high voltage still more, as shown in Fig. 2.

(2) Increase the high-voltage rectifier filament voltage by adding another turn of wire to the filament winding, or by eliminating the series filament resistor, R_1 . Note that 1.25 volts is the maximum permissible filament voltage for the 1B3 and 1X2 tube types.

(3) Decrease the size of the horizontal output tube screen and cathode resistors, R_3 and R_2 , and increase the "B+" voltage to the horizontal oscillator stage. Note that these methods may also result in a decrease in raster width.

Although the opposite of these procedures will result in a decrease of high voltage, one very effective way of doing the latter is to shunt the damper tube with a 10,000 to 50,000 ohm, 10 watt resistor.

Q—What causes a corona discharge? How can it be eliminated?

A—Corona may be heard (as a "sizzling" or "popping" sound), smelled (as ozone gas), or seen (as blue-green flashes). If it is heard or smelled, but cannot be seen, simply raise the a.c. line voltage or increase the drive to the horizontal output stage. If permitted to remain, corona will result in permanent flyback transformer damage.

Corona is caused by the accumulation of high-voltage energy at a sharp-edged metallic point such as a piece of solder or a terminal lug. This energy comes from high-voltage leakage due to dust or moisture. Sometimes improper lead dress between a high-voltage lead and a chassis or low-voltage point will cause corona.

To eliminate corona, remove or round off all sharp-edged metallic points in the vicinity of high-voltage circuits by filing or cutting. A corona ring may be substituted for a connection. Spray anti-corona dope (or an acrylic compound) around the corona area. Clean the high-voltage compartment area carefully with a rag or air-hose, being sure not to disturb the lead dress.

Q—How can horizontal linearity be altered?

A—(1) Use a linearity coil, L_2 in Fig. 3, with a lower inductance range. Inasmuch as such a coil does less filtering, a greater ripple voltage appears at the horizontal output tube plate; this has a greater effect on the instantaneous plate voltage and, in turn, the horizontal linearity. The disadvantage of this method is that the linearity adjustment becomes more critical.

(2) Reduce the capacitor, C_2 , connected at the junction of the linearity coil and the flyback transformer to about one-fourth of the value found in the circuit.

(3) Connect the damper plate (or cathode, in the autotransformer-type flyback circuit) to a different terminal on the flyback secondary. A higher-

potential point compresses the left side of the picture, whereas a lower-potential point stretches the left side. This method may, however, cause "ringing" or horizontal foldover.

(4) Use a higher inductance width coil to stretch the right side of the picture.

Q—How should the flyback transformer filament winding(s) be connected in a replacement transformer?

A—The replacement transformer should have the same number of high-voltage rectifier filament windings and turns as the original one. To add turns to a filament lead, remove it, wrap it around the core to produce the required number of turns, tighten the lead, and secure it in place by taping it near the core, as shown in Fig. 4. If the original transformer incorporates a filament series-dropping resistor, be sure to insert the same value resistor in the filament winding of the replacement transformer.

After the high-voltage rectifier filament lead is secured, measure the filament voltage. It should be about 1 volt a.c.; 1.25 volts is the maximum permissible value. If there is less than one volt, remove the series-dropping resistor, if one exists; tighten the coupling between the filament winding and the core; and, if necessary, add one or more turns. If the filament voltage is greater than 1.25 volts, insert a series filament resistor. Such values as 2.2, 3.3, 3.9, or 4.3 ohms ($\frac{1}{2}$ watt, 10%) may be used.

Q—What causes flyback transformer "singing" and how can it be eliminated?

A—Flyback transformer "singing" is a high-pitched whistle, occurring at 15,750 cps, which may be objectionable to those who can hear it. It is an inherent mechanical resonant condition, where the core is usually the vibrating medium. A loose lead connected to the flyback transformer, or a turn of wire on the transformer itself, may also be responsible for this condition. To eliminate this condition, all leads must be tightened and, if necessary, redressed. Re-adjust the drive, width, and horizontal linearity controls. Tighten the screws or bolts which hold the core to

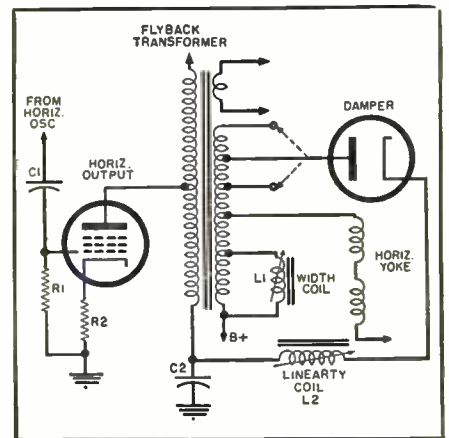

Fig. 3. Partial schematic diagram of a typical sweep circuit. Methods for obtaining more control of the horizontal linearity of such a circuit and similar ones are explained in the text.

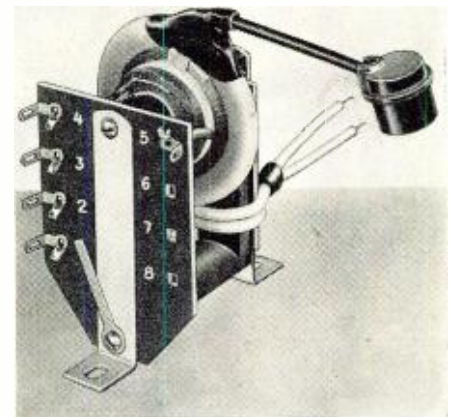

Fig. 4. Typical flyback transformer with a single high-voltage rectifier filament winding on the core at the lower right.

the terminal board and mounting bracket; extreme care must be exercised not to crack the core or terminal board. Apply a carbon compound or insulating wax between the core and bracket, and core and terminal board. Mount the flyback transformer more securely to the chassis by inserting rubber cushioning between the transformer and the chassis and by tightening the mounting screws as much as possible.

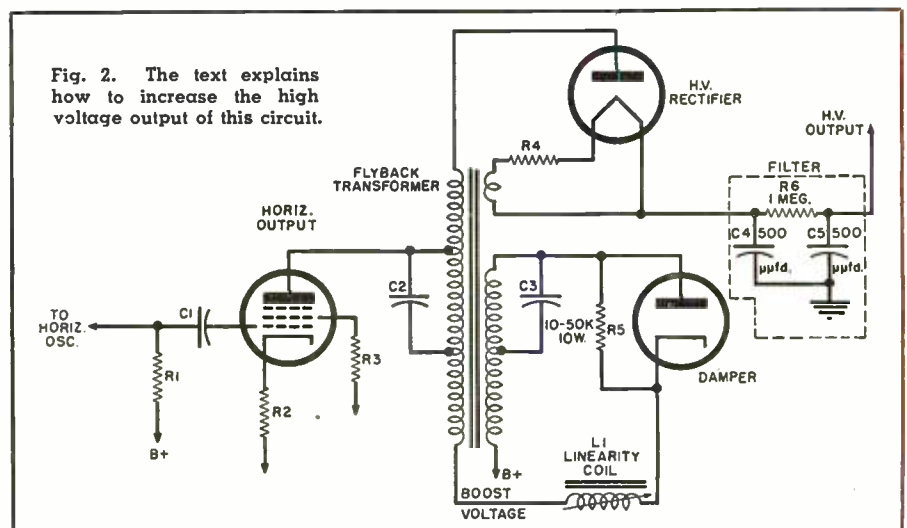

Fig. 2. The text explains how to increase the high voltage output of this circuit.

New Model TV-11



- ★ Tests all tubes including 4, 5, 6, 7, Octal, Lockin, Peanut, Bantam, Hearing Aid, Thyatron, Miniatures, Sub-Miniatures, Novals, Sub-minars, Proximity fuse types, etc.
- ★ Uses the new self-cleaning Lever Action Switches for individual element testing. Because all elements are numbered according to pin-number in the RMA base numbering system, the user can instantly identify which element is under test. Tubes having tapped filaments and tubes with filaments terminating in more than one pin are truly tested with the Model TV-11 as any of the pins may be placed in the neutral position when necessary.

- ★ The Model TV-11 does not use any combination type sockets. Instead individual sockets are used for each type of tube. Thus it is impossible to damage a tube by inserting it in the wrong socket.
- ★ Free-moving built-in roll chart provides complete data for all tubes.
- ★ Newly designed Line Voltage Control compensates for variation of any Line Voltage between 105 Volts and 130 Volts.
- ★ NOISE TEST: Phono-jack on front panel for plugging in either phones or external amplifier will detect microphonic tubes or noise due to faulty elements and loose internal connections.

EXTRA SERVICE — The Model TV-11 may be used as an extremely sensitive Condenser Leakage Checker. A relaxation type oscillator incorporated in this model will detect leakages even when the frequency is one per minute.

The model TV-11 operates on 105-130 Volt 60 Cycles A.C. Comes housed in a beautiful hand-rubbed oak cabinet complete with portable cover.

\$47⁵⁰
NET



New Model TV-40

C.R.T. TUBE TESTER



- Tests all magnetically deflected tubes . . . in the set . . . out of the set . . . in the carton!!

- A complete picture tube tester for little more than the price of a "make-shift" adapter!!

The Model TV-40 is absolutely complete! Self-contained, including built-in power supply, it tests picture tubes in the only practical way to efficiently test such tubes; that is by the use of a separate instrument which is designed exclusively to test the ever increasing number of picture tubes!

SPECIFICATIONS

Tests all magnetically deflected picture tubes from 7 inch to 30 inch types. • Tests for quality by the well established emission method. All readings on "Good-Bad" scale. • Tests for inter-element shorts and leakages up to 5 megohms. • Test for open elements.

Model TV-40 comes absolutely complete — nothing else to buy. Housed in round cornered, molded bakelite case. Only

\$15⁸⁵
NET

20,000 OHMS PER VOLT

New!



Model TV-60

ALLMETER



Includes services never before provided by an instrument of this type. Read and compare features and specifications below!

SPECIFICATIONS

8 D.C. VOLTAGE RANGES (At a sensitivity of 20,000 Ohms per Volt) 0 to 15/75/150/300/750/1500/7500/30,000 Volts.

7 A.C. VOLTAGE RANGES: (At a sensitivity of 5,000 Ohms per Volt) 0 to 15/75/150/300/750/1500/7500 Volts.

3 RESISTANCE RANGES: 0 to 2,000/200,000 Ohms, 0-20 Megohms.

2 CAPACITY RANGES: .00025 Mfd. to 30 Mfd.

5 D.C. CURRENT RANGES: 0-275 Microamperes, 0 to 7.5/75/750 Milliampers, 0 to 15 Amperes.

3 DECIBEL RANGES: -6 db to + 58 db.

R.F. SIGNAL TRACER SERVICE: Enables following the R.F. signal from the antenna to speaker of any radio or TV receiver and using that signal as a basis of measurement to first isolate the faulty stage and finally the component or circuit condition causing the trouble.

AUDIO SIGNAL TRACER SERVICE: Functions in the same manner as the R.F. Signal Tracing service specified above except that it is used for the location of cause of trouble in all audio and amplifier systems.

FEATURES

- ★ Giant recessed 6½ inch 40 Microampere meter with mirrored scale.
- ★ Built-in Isolation Transformer.
- ★ Use of the latest type printed circuit and 1% multipliers assure unchanging accurate readings.

Model TV-60 comes complete with book of instructions; pair of standard test leads; high-voltage probe; detachable line cord; R.F. Signal Tracer Probe and Audio Signal Tracer Probe. Pilefilm bag for all above accessories is also included. Price complete. Nothing else to buy. ONLY

\$52⁵⁰
NET

EXAMINE BEFORE YOU BUY!
USE APPROVAL FORM ON NEXT PAGE

New!



SUPER-METER

The new Model 670-A

SUPER-METER

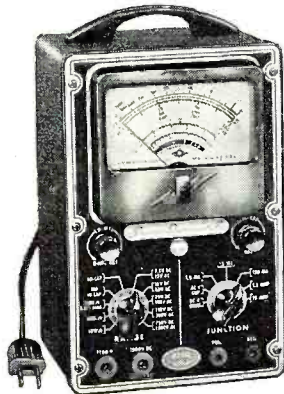

SPECIFICATIONS
 D.C. VOLTS: 0 to 7.5/15/75/150/750/1,500/
 7,500 Volts
 A.C. VOLTS: 0 to 15/30/150/300/1,500/3,000
 Volts
 OUTPUT VOLTS: 0 to 15/30/150/300/1,500/
 3,000 Volts
 D.C. CURRENT: 0 to 1.5/15/150 Ma. 0 to
 1.5/15 Amperes
 RESISTANCE: 0 to 1,000/100,000 Ohms 0 to
 10 Megohms
 CAPACITY: .001 to 1 Mfd. 1 to 50 Mfd. (Good-
 Bad scale for checking quality of electrolytic
 condensers.)
 REACTANCE: 50 to 2,500 Ohms 2,500 Ohms
 to 2.5 Megohms
 INDUCTANCE: .15 to 7 Henrys 7 to 7,000
 Henrys
 DECIBELS: -6 to +18 +14 to +38 +34 to
 +58

ADDED FEATURE:

Built-in ISOLATION TRANSFORMER reduces pos-
sibility of burning out meter through misuse,

The Model 670-A comes housed, in a rugged
crackle-finished steel cabinet complete with
test leads and operating instructions.

\$2840
NET

**SHIPPED ON
 APPROVAL
 NO MONEY
 WITH ORDER
 NO C.O.D.**

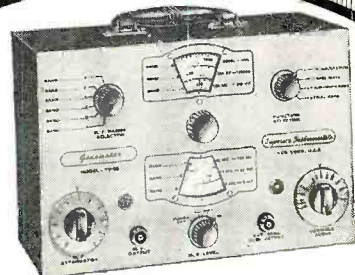

The new
Model TV-50

GENOMETER

A versatile all-inclusive GENERATOR which provides ALL the outputs for servicing:
A.M. Radio • F.M. Radio • Amplifiers • Black and White TV • Color TV

R. F. SIGNAL GENERATOR: Provides complete coverage for A.M. and F.M. alignment.
Generates Radio Frequencies from 100 Kilocycles to 60 Megacycles on funda-
mentals and from 60 Megacycles to 180 Megacycles on powerful harmonics. •
VARIABLE AUDIO FREQUENCY GENERATOR: In addition to a fixed 400 cycle sine-
wave audio, the Genometer provides a variable 300 cycle to 20,000 cycle peaked
wave audio signal. • BAR GENERATOR: Projects an actual Bar Pattern on any
TV Receiver Screen. Pattern will consist of 4 to 16 horizontal bars or 7 to 20
vertical bars. • CROSS HATCH GENERATOR: Genometer will project a cross-
hatch pattern on any TV picture tube. The pattern will consist of non-shifting
horizontal and vertical lines interlaced to provide a stable cross-hatch effect.
• DOT PATTERN GENERATOR (FOR COLOR TV): The Dot Pattern projected on any
color TV Receiver tube by the Model TV-50 will enable you to adjust for
proper color convergence. • MARKER GENERATOR: The following markers are
provided: 189 Kc., 262.5 Kc., 456 Kc., 600 Kc., 1000 Kc., 1400 Kc., 1600 Kc.,
2000 Kc., 2500 Kc., 3579 Kc., 4.5 Mc., 5 Mc., 10.7 Mc., (3579 Kc. is the
color burst frequency.)

MODEL TV-50 comes abso-
lutely complete with
shielded leads and
operating instruc-
tions.

Only

\$4750
NET

TRY ANY
of the instruments on this or
on the facing page, for 10 days
before you buy. If completely satis-
fied **then** send down payment and pay
balance as indicated on coupon. **No**
Interest or Finance Charges Added!
If not completely satisfied return
unit to us, no explanation
necessary.

MOSS ELECTRONIC DISTRIBUTING CO., INC.

Dept. D-216, 3849 Tenth Ave.
New York 34, N. Y.

Please send me the units checked. I agree to
pay down payment within 10 days and to pay
the monthly balance as shown. It is under-
stood there will be no finance, interest or any
other charges, provided I send my monthly
payments when due. It is further understood
that should I fail to make payment when due,
the full unpaid balance shall become imme-
diately due and payable.

Name _____
 Address _____
 City _____ Zone _____ State _____

- Model TV-60.....Total Price \$52.50
\$12.50 within 10 days. Balance \$8.00
monthly for 5 months.
- Model 670-A.....Total Price \$28.40
\$7.40 within 10 days. Balance \$3.50
monthly for 6 months.
- Model TV-11.....Total Price \$47.50
\$11.50 within 10 days. Balance \$6.00
monthly for 6 months.
- MODEL TV-40.....Total Price \$15.85
\$3.85 within 10 days. Balance \$4.00
monthly for 3 months.
- Model TV-50.....Total Price \$47.50
\$11.50 within 10 days. Balance \$6.00
monthly for 6 months.

BEWARE

OF IMITATIONS

There Is Only One
Original **DEPENDABLE**

“**NO NOISE**”

Insist On
New **NO-NOISE**

**TUNER
TONIC**

with
PERMA-FILM

Cleans, lubricates, restores all tuners including wafer type.

Positively won't change or affect capacities, inductance or resistance. Won't harm insulations or precious metals, nor attack plastics. For television, radio and FM. Eliminates all noise, oxidation and dirt indefinitely.

Non-toxic! Non-inflammatory! Insures trouble-free performance!

Extra economical because a small amount does the job.



6 oz. Aerosol Can
\$3.25
Net to servicemen

**VOLUME CONTROL and
CONTACT RESTORER**

with **PERMA-FILM**



**CLEANS!
LUBRICATES!
PROTECTS!**

This new, improved product is NOT a carbon-tet solution. Still available in the new 6 oz. spray can. Net to servicemen.

\$2.25

\$1.00

2 oz. bottle, net to servicemen.

Also available in 8 oz. bottles and quart cans.

At your nearest Distributor!

Electronic Chemical Corp.

813 COMMUNIPAW AVENUE
JERSEY CITY 4, N. J.

REMOTE SWITCHING CIRCUIT

By **WARNER CLEMENTS**

Details on a safe and simple switching circuit which draws no standby power yet is fast-acting when needed.

HERE'S a familiar problem: You want to control a power circuit from a distance, using light duty, temporary, or portable wiring. Perhaps the circuit to be controlled draws heavy current and you don't want to route that current through the control wiring, or perhaps the switching required is more complicated than simple single-pole, single-throw. In either case the use of a relay is indicated.

The next problem is where to get the power to energize the relay. The simplest thing to do is to use the power line for the purpose, in an arrangement like that of Fig. 1. This method is popular with hams and hi-fi addicts in particular. It certainly does the job. The trouble with it is that the full energy of the 117 volt line can go anywhere the control circuit goes. That energy is something to be reckoned with. It can be delivered to any tiny point where something goes wrong at the rate of two full horsepower without even blowing a fuse! So the arrangement of Fig. 1 is only as safe as the control wiring. We shudder to think of how many times such wiring is tacked to a baseboard or run under a carpet and forgotten. *A deal like this can electrocute your child or burn your house down.* Moreover in case of fire the insurance company may refuse to pay off on the grounds that the building was wired illegally.

Electrical wiring codes usually limit wiring that is not enclosed in firesafe metal or asbestos to that used in circuits of 24 volts or less. At that, they are perhaps a trifle optimistic. Many an automobile fire has started in six volt wiring. Fortunately the stepdown transformers used to develop the lower voltages are not capable of delivering enough power to do much harm. For the purpose of remote switching a system like that of Fig. 2 can be made to conform with wiring codes and common sense as well. With this arrangement you can treat the control circuit wiring as roughly as you like and never worry about a thing. The transformer used here normally remains connected

across the line. Hence it is best to use a type especially designed for this sort of service in order that the power consumption on standby will be small. The UTC SC-3 is such a type as is the "bell" transformer that hardware stores sell.

The circuit of Fig. 3 is suggested as an alternative to that of Fig. 2. The Fig. 3 arrangement calls for the use of three resistors, a capacitor, and a grid glow tube at the switching location. These parts cost about the same as the transformer they replace. The system has the following advantages:

1. In the transformer system. Fig. 2, fairly heavy wire is required in the control circuit and the possible distance to the control point is limited by voltage drop in wiring due to the relatively high control current required at the low operating voltage. The relay tube system of Fig. 3, by contrast, is practically immune to series resistance in the control circuit; at least until that resistance approaches the megohm region. As a result, fine wire may be used and it may be run for great distances. Steel wire or resistance wire will work as well as copper, provided only that it is well insulated. With many individual grid glow tubes, particularly when they are comparatively fresh, it is even possible to dispense with the control switch and close the circuit through the dry skin of one's hand. For example it is possible to cement a small electrode on the handle of a spray gun, the gun itself being grounded, so that the associated compressor will start up automatically whenever the spray gun is grasped around the handle.

2. Ground connections are available nearly everywhere so the relay tube setup, in most cases, will require only one wire in the control circuit. The ground need not be a particularly good one. There is no need for a ground at the relay end; the power company conveniently takes care of that detail.

3. If properly constructed, the Fig. 3 arrangement is quite safe. The high resistance isolates the control circuit

Fig. 1. A common type of switching circuit which works well but is somewhat dangerous since 117 volts is present in system.

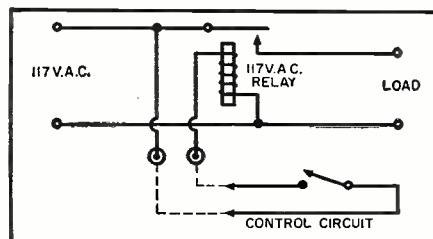
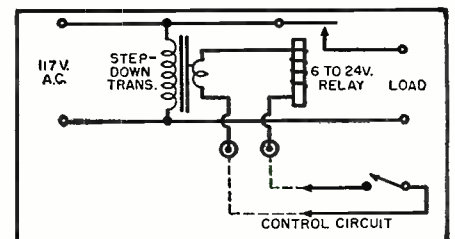

Fig. 2. A safer method of controlling remote operations. It uses a small transformer which draws power continuously.



**There is
immediate opportunity
with**

RCA

at the

MISSILE TEST PROJECT

**... for Instrumentation and
Communication Technicians**

Enhance your future—investigate our new programs in Long Range Missile Test Instrumentation. These programs require immediate implementation. They extend far into the future and offer unprecedented opportunity.

AERO • BALLISTIC • SPACE

You need technical schooling and experience in the operation and maintenance of electronic equipment.



Radar

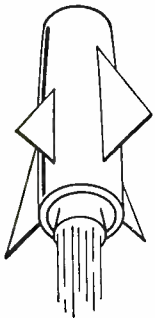
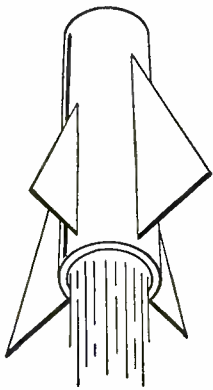

Photo-Optics

Timing

Telemetry



Communications

Data Reduction

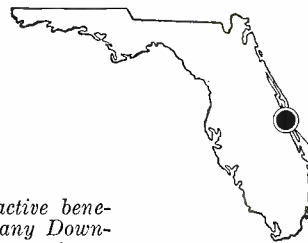

Florida sunshine provides an ideal climate both for missile testing and pleasant living.

Many attractive benefits accompany Down-Range assignments.



To arrange a prompt personal interview in your locality, write to:

**Mr. H. C. Laur, Technical Employment, Missile Test Project
RCA Service Co., Inc., P. O. Box 1226, Melbourne, Florida**

RADIO CORPORATION of AMERICA

Time for Replacement?

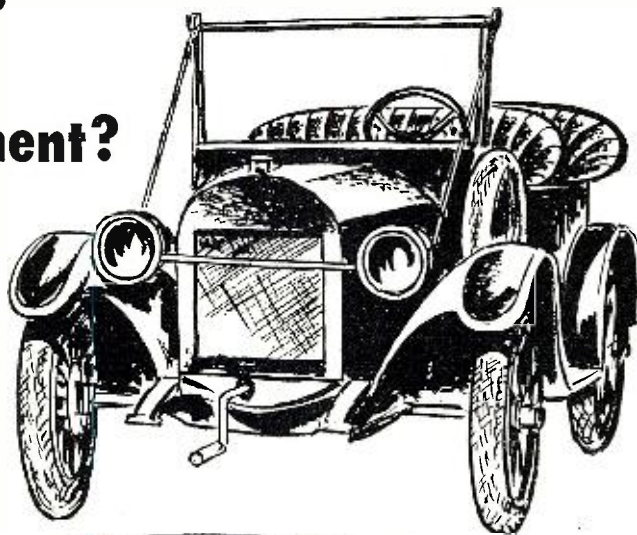

Specify **OXFORD** SPEAKERS

We **GUARANTEE** you speakers that are built to be the finest exact replacement speakers. We stand behind each and every speaker with a 100% guarantee against any mechanical or electrical defects for one full year.

OXFORD Replacement Speakers undergo a rigid inspection to make certain that they are as good or better than the original speaker. That's why more servicemen are switching to **OXFORD** . . . when it's time for replacement.

Illustrated literature is available without obligation. . . . at better jobbers!

OXFORD ELECTRIC CORPORATION

Distributor Sales Division

556 West Monroe Street, Chicago 6, Ill.

In Canada: Atlas Radio Corp., Ltd., Toronto

Export: Roburn Agencies, New York City



Oscillograph !!! Hickok Model RFO-5
This precision instrument originally cost \$400.00! Contains 0-3 MC. vertical amplifier, 10-30 and 100-900 Kc. frequency modulated sweep, 0-40 Kc. sawtooth sweep, Demodulator input, Voltage calibrated vertical control. New in original package. Get this high quality lab and service test instrument at fraction of former price!
\$59.50
Quantity limited
SET OF SPARE TUBES, including scope tube, \$5.95 extra.

MINIATURE HAND CRANK GENERATOR
Latest type, light weight. From recent model field phone. Many uses. Brand new. Terrific buy!
\$1.49

FREE! On request, with every purchase of \$3.00 or more, one J-51 Hand Code Key!

COMMAND TRANSMITTERS
2-3 MC. Good condition. \$ 4.95
3-4 MC. Good condition. 4.95
4-5 MC. Good condition. 3.95
ARB REC'V'R. 190 Kc-9.5 MC. Good cond. . . 14.95

1-222 SIGNAL GENERATOR MICRO-VOLTER
Freq. range: 8-15 MC. and 150-230 MC. Complete with all tubes and 9 MC. calibration crystal. Set contained 110V. 60 cyc. power supply.
\$19.95
Good condition
CATALOGUE NO. 105 IS OFF THE PRESS!
Get your free copy today!
All items F.O.B. L.A. Prices subj. to change without notice. Calif. buyers add tax. Send 25¢ deposit with C.O.D. orders
J. J. GLASS ELECTRONICS CO.
1615 S. Main St. Los Angeles 15, Calif.

Grayburne VARI-LOOPSTICK
List **\$1.00**

World's most sensitive, compact, small radio antenna. Replaces inefficient loops. DON'T ACCEPT IMITATIONS! Ask for the Vari-Loopstick by name.
SUPEREX Yonkers, N. Y.

TV TUNER REPAIRS
48-HOUR SERVICE
Defective tuners rebuilt to factory standards. New tuner guarantee. Ship prepaid.
RADIO PRODUCTS CO.
15-20 122nd Street • College Pt. 56, N. Y.
We carry a full line of Replacement Tuners for all makes of T.V.

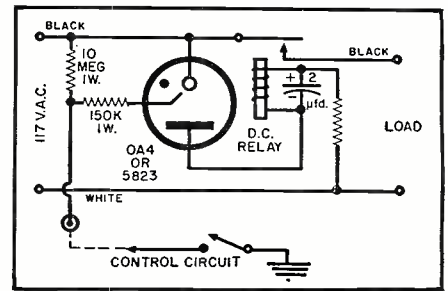

Fig. 3. An improved version of Fig. 2 which requires no standby power and uses three resistors, a capacitor, and a glow tube.

from power line. There is no inductive kick on break and no spark whatsoever.

4. Even though the power consumed by the transformer system on standby is small, it is continuous, 24 hours-per-day. The relay tube system draws no standby power at all.

There are two available tube types which will work in this circuit. One is the 0A4G octal; the other is its miniature cousin, the 5823. If you use the 5823 be sure that you don't connect anything to unused socket terminals. The relay may be any type (with a winding of over 1200 ohms) that will operate reliably on 30 volts. There are several war surplus types available that will fill the bill. However I know of no relay that will operate in this circuit that is capable of controlling a 1/4 horse or larger motor. If you have to switch a motor, it would be advisable to add a bigger relay, wiring the contacts of the plate circuit relay to control the additional one.

The value of the resistor shown in series with the relay winding will depend upon the relay that is used. The resistor should be chosen by experiment so that the drop across the relay with the tube fired does not exceed 30 volts. This precaution is necessary in order to ensure that applied peak inverse voltage will not exceed tube ratings. In installing the other two resistors, care should be taken that the point in the circuit to which the control lead is attached is well insulated.

If the tube fails to fire when the control switch is closed, reverse the line plug. The terminal marked "white" should go to the cold side of the line. In the event that the leakage resistance to ground of the control wire is too low, the tube may fire when the wire is connected, without waiting for the control switch to be closed. This effect can be avoided by the use of plastic-covered wire (small indoor antenna wire works fine) and plastic taping or spraying at splices. Alternatively, the leakage can be balanced out by reducing the value of the 10 megohm resistor. However for safety's sake it should not be cut to below one megohm. In the case of a very long control line the tube may fire on open switch due to capacitance to ground of the line. This is easily taken care of by connecting a small capacitor of corresponding value across the 10 megohm resistor.

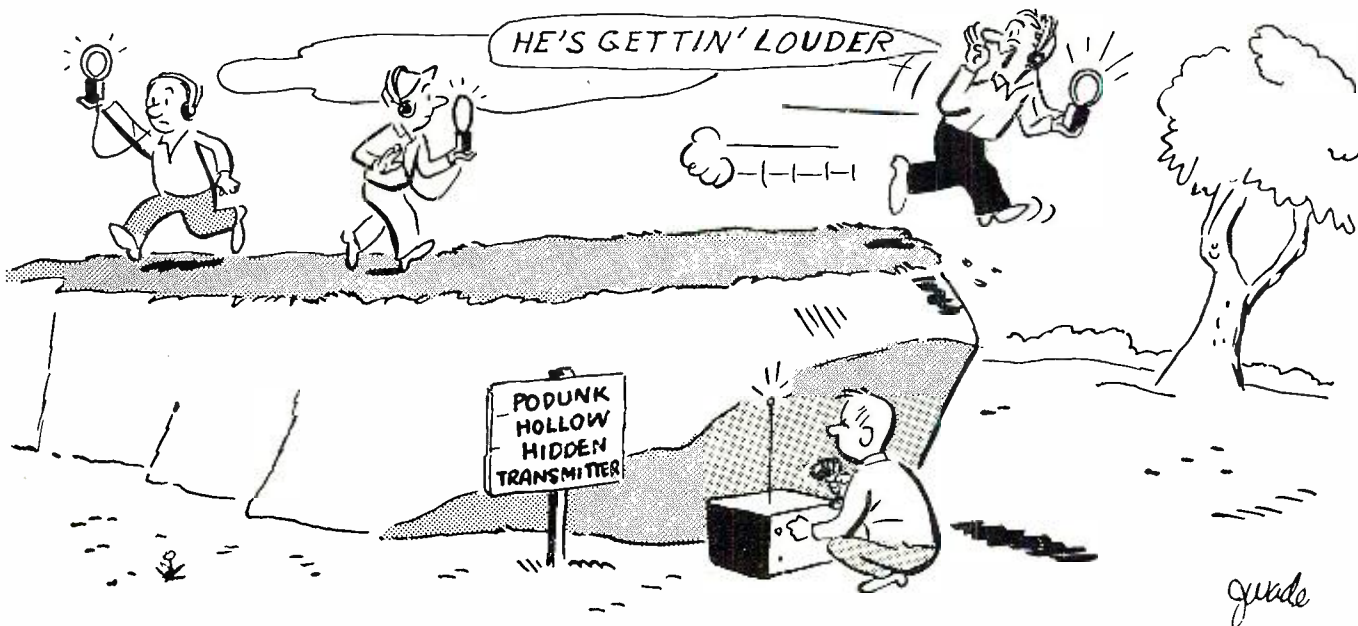

NEW HAM GEAR

Save money on that new amateur gear. Let Walter Ashe make you a "Surprise" trade-in allowance on your used (factory-built) test and communications equipment. Use the handy coupon and get your trade-in deal working today.

**JOHNSON VIKING
RANGER KIT**
Net.....\$ 214.50

Wired and tested
Net.....\$ 293.00

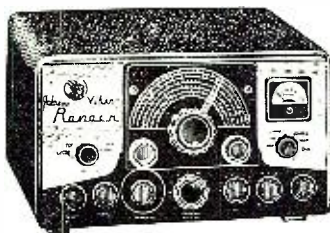

**HALLICRAFTERS
SX-100**
Less speaker
Net.....\$ 295.00

**NATIONAL
NC-300**
Less speaker
Net.....\$ 349.95



UNLUCKY

13



It seems 13 is our unlucky number but it can sure be the luckiest number in your life. We've got such a tremendous stock of the 13 items listed below, our used warehouse is bulging at the seams.

Rather than just lower the prices on these items, we've positively smashed them! Where else can you buy a Collins Transmitter for \$179.50, a Collins Receiver for \$199.50, or a current model receiver like the National HRO-60 for less than \$300.00?

This stuff has got to go. The price is right, and they just won't last. Don't take too long to make up your mind. Look over the list right now and send us your order at once. Please give a first and second choice if possible. 20% deposit required on C.O.D. orders. No equipment held without a deposit. All receivers are less speakers.

COLLINS 32V-1	\$ 179.50	NATIONAL HRO-50	149.95
COLLINS 32V-3	374.50	NATIONAL HRO-50T1	249.95
COLLINS 75A-1	199.50	NATIONAL HRO-60	299.50
COLLINS 75A-2	249.50	NATIONAL NC-98	99.50
COLLINS 75A-3	299.50	NATIONAL NC-183D	199.50
HALLICRAFTERS SX-88	399.50		
HAMMARLUND HQ-129X	99.50		
HAMMARLUND HQ-140X	179.50		

ASK ABOUT OUR
TIME PAYMENT PLAN

WRITE FOR FULL INFORMATION
ABOUT OUR TIME PAYMENT PLAN

All prices f. o. b. St. Louis • Phone CHestnut 1-1125



WALTER ASHE RADIO COMPANY
1125 Pine Street, St. Louis 1, Mo.

RN-3-56

Rush my order for used equipment as follows:

(1st Choice).....
(2nd Choice).....

Remittance for \$..... is enclosed.

Send free list of additional used equipment bargains.
 Send new free 1956 Walter Ashe catalog.

Rush "Surprise" Trade-In offer on my.....
for.....
(show make and model of new equipment desired)

Name.....

Address.....

City..... Zone..... State.....

LAFAYETTE

... Easy to Build



New!
Model
625K
\$34⁹⁵

TUBE TESTER KIT MODEL 625K

- LARGE 4 1/2" RUGGED METER WITH 3-COLOR REPLACE-WEAK-GOOD SCALE SHOWS TUBE CONDITION AT A GLANCE.
- TESTS NEW 600 MIL SERIES STRING TYPE TUBES
- ILLUMINATED GEAR DRIVEN "SPEEDWELL" ROLL CHART WITH SPECIAL ANTI-BACK-LASH DESIGN.

Highly dependable Cathode Conductance tube tester with simple test set-up procedure for checking emission, shorted elements, open elements, and continuity. Features 10 individual lever-type element switches for complete flexibility. Tests all standard AM, FM and TV tubes

such as 4, 5, 6, large and small 7, octal, loctal, noval, hytron, VR, magic eye, and pilot lamps. Has blank spare socket for future tube types. Protective overload bulb shows transformer overloads and acts as fuse. Simple and reliable line adjust control. Has two grid caps for extra convenience. Filament voltages available: 0, .75, 1.4, 2.0, 2.5, 3.3, 5.0, 6.3, 7.5, 12.6, 25, 32, 50, 70, 110. Roll charts kept up-to-date periodically. Requires 105-125 volts AC, 50/60 cps, 6 watts. Dimensions: 9 1/2" high, 12 1/2" wide, 4 1/4" deep. Shpg. wt., 13 lbs.

EICO MODEL 625K — KIT, Complete Net **34.95**
MODEL 625 — Factory Wired Net **49.95**
MODEL CRA TV Picture Tube Test Adapter — Factory Wired Net **4.50**



RF SIGNAL GENERATOR KIT MODEL 324K

Model 324K
\$26⁹⁵

- ONE GENERATOR COVERS THE WHOLE RANGE OF 150kc to 435mc!
- HAILED AS THE BEST GENERATOR BUY IN THE WORLD!
- FOR COLOR & MONOCHROME TV SERVICING!

A superb instrument for IF-RF alignment, signal tracing and trouble-shooting of TV, FM and AM sets, all on fundamentals; marker generator for alignment of new high-frequency as well as older low-frequency TV IF's; 400 cps sine wave audio testing; laboratory and experimental work. Features Colpitts RF oscillator directly plate modulated by cathode follower for improved modulation; $\pm 1.5\%$ frequency accuracy; variable gain external modulation amplifier — only 3.0 volts needed for 30% modulation; 6:1 vernier tuning knob and excellent spread at most important alignment windows, edge-lit hairlines, for utmost accuracy, convenience and professional appearance. Covers 6 fundamental bands: 150-400kc, 400-1200kc, 1.2-3.5mc, 3.5-11mc, 11-37mc, 37-145mc; one harmonic band, 111mc-435mc; RF output 100,000 microvolts; AF output to 10 volts; Tube complement — 12AU7, 12AV7, selenium rectifier, transformer operated. Handsome satin aluminum front panel and grey wrinkle steel case. For 105-125 volts AC, 50/60 cps. Size: 8" H, 10" W, 4 3/4" D. Shpg. wt., 10 lbs.

EICO MODEL 324K — KIT Complete Net **26.95**
MODEL 324 — Factory Wired Net **39.95**

PEAK-TO-PEAK VTVM KIT MODEL 232K

- THE NEW LEADER IN PROFESSIONAL PEAK-TO-PEAK VTVM'S!
- WITH THE SENSATIONAL AC/DC UNI-PROBE!
- FOR COLOR AND MONOCHROME TV/FM/AM/ELECTRONIC SERVICING WITH HIGHEST ACCURACY!



Model 232K
\$29⁹⁵

By far the best professional VTVM value in electronics! Features a large 4 1/2" meter in a can't burn-out circuit, zero-center for TV-FM discriminator alignment, dual-purpose AC/DC UNI-PROBE — a half-turn of probe-tip selects DC or AC-ohms, new balanced bridge circuit for exceptional stability and accuracy, calibration without removing from cabinet, high impedance input for negligible circuit loading, 1% precision ceramic multiplier resistors, transformer operated for isolation and safety.

Measures directly Peak-to-Peak AC Volts . . . 0-4, 14, 42, 140, 420, 1400, 4200; DC/RMS Sine Volts . . . 0-1.5, 5, 15, 50, 150, 500, 1500 (DC up to 30,000 volts with HVP probe); Frequency response . . . 30 cps to 3mc (up to 250mc with PRF probe). Ohmmeter . . . 0.2 ohms to 1000 megohms in 7 ranges. Uses 12AU7, 6AL5, selenium rectifier and 1.5 volt battery. For 105-125 VAC, 50/60 cps, 5 W. Smart professional styling-satin finish etched aluminum panel, grey wrinkle steel case. Size: 8 1/2" H, 5" W, 5" D. Shpg. wt., 7 lbs.

EICO MODEL 232K — KIT, Complete Net **29.95**
MODEL 232 — Factory Wired Net **49.95**
DELUXE PEAK-TO-PEAK VTVM with 7 1/2" Meter and UNI-PROBE
MODEL 249K — KIT, Complete Net **39.95**
Model 249 — Factory Wired Net **59.95**

RESISTANCE-CAPACITANCE BRIDGE AND R-C-L COMPARATOR KIT MODEL 950BK

- 4 SEPARATE CAPACITY AND RESISTANCE RANGES!
- DIRECT READINGS ON CALIBRATED FRONT PANEL!



Model 950BK
\$19⁹⁵

The only instrument of its kind with a Comparator Range for measurement of capacitance, resistance and inductance with a complementary component as a standard. Features direct reading scales for measurement of capacitance and resistance, direct reading ratio scale for comparison measurement of capacitance, inductance and resistance, extremely sensitive leakage indication directly in eye tube, sensitive magic eye tube null indicator, and continuously variable polarizing leakage test voltage 0 to 500 volts DC. Directly reads 0.5 ohms to 500 megohms (4 ranges), 10 mmf to 500 mf (4 ranges), and electrolytic power factor. Has Comparator ratio from .05 to 20 (400 to 1), and 0 to 500 volts DC polarizing voltage. For 105-125 volts AC, 50/60 cps. Smart professional styling — satin finish deep-etched aluminum panel, grey wrinkle steel case. Size: 8" H, 10" W, 4 3/4" D. Shpg. wt., 8 lbs.

EICO MODEL — 950BK — Kit Complete Net **19.95**
MODEL 950B — Factory Wired Net **29.95**

DeLUXE MULTI-SIGNAL TRACER KIT MODEL 147K



- A DeLuxe Signal Tracer — Invaluable for TV, FM, AM, Audio, Electronic Servicing!
- See and Hear the Signal Level in Each Stage!

Model 147K
\$24⁹⁵

For signal tracing and trouble-shooting in RF, IF and audio stages in AM, FM and TV sets . . . locating noisy components . . . checking equipment power consumption. Features high-gain RF and low-gain audio with RF gain more than adequate for tracing up to receiver input; Visual and aural signal monitors (eye tube and speaker) — facilitates estimation of signal strength and gain per stage. Shielded RF crystal demodulator and direct probes; Noise locator ferrets out noisy controls, resistors, capacitors, coils, transformers, cold solder joints, etc.; Calibrated wattmeter reveals abnormal power consumption and detects B+ short, intermittent filament circuit, defective filter, etc. Fused for safety; Transformer operated for isolation and safety. Has 1-6SQ7, 1-ated for isolation and safety. Has 1-6SQ7, 1-6SJ7, 1-6K6, 1-1629 and 1-6X5 tubes. For 105-125 volts AC, 50/60 cps, 40 watts. Satin finish deep-etched aluminum panel and grey wrinkle steel case. Size: 8" H, 10" W, 4 3/4" D. Shpg. wt., 12 lbs.

EICO MODEL 147K — Kit, Complete Net **24.95**
MODEL 147 — Factory Wired Net **39.95**



THE ONLY LINE OF KITS
WITH ALL THESE FEATURES



EASY TO BUILD . . . Every Kit is complete with an easy to follow instruction manual, replete with pictorial and schematic diagrams and step-by-step instructions for building and operation. Any one can do it.

QUALITY . . . Deep etched panels are used throughout the kits giving a fine professional appearance. Only first quality brand new parts of leading manufacturers are used.

ECONOMY . . . Building is not only fun and educational; it saves you a substantial amount of money. Compare the price of the wired unit with the price you pay for the kit.

LIFETIME SERVICE GUARANTEE

LAFAYETTE RADIO

100 SIXTH AVE., NEW YORK, N. Y.

BOSTON, MASS., 110 Federal St.
PLAINFIELD, N. J., 139 West 2nd St.
NEWARK, N. J., 24 Central Ave.
BRONX, N. Y., 542 E. Fordham Rd.



Kits

The Only Line Of Kits With A

Lifetime Service Guarantee

6V & 12V BATTERY ELIMINATOR & CHARGER KIT MODEL 1050K

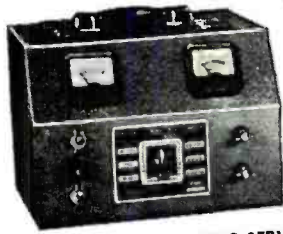

EICO
Model 1050K
\$29⁹⁵

- A MUST FOR CAR RADIO SERVICING!
- A BOON TO THE MOTORIST FOR BATTERY CHARGING!

A convenient and reliable source of DC voltage, model 1050 has many more applications in addition to car radio servicing and battery charging. It runs many small electric appliances such as shavers, trains, etc. For marine use, it operates boat lights, radio-phones, bilge blower, bilge pump, etc. Model 1050 features two DC voltage ranges, 0-8 volts and 0-16 volts. Continuous voltage adjustment with variac-type transformer; Separate voltmeter and ammeter for simultaneous readings of both voltage and current; Heavy duty selenium rectifiers; Fused primary — automatic reset overload relay for secondary. 10 amps continuous and 20 amps intermittent current rating for 0-8 volt range; 6 amps continuous, 12 amps intermittent for 0-16 volt range. Voltmeter scale 0-20 volts; Ammeter scale 0-20 amps. For 105-125 volts AC, 50/60 cps, 150 watts. Size: 8 3/4" H, 10 1/2" W, 7 3/4" D. Shpg. wt., 15 lbs.
EICO MODEL 1050K — Kit, Complete Net 29.95
MODEL 1050 — Factory Wired Net 38.95

5" PUSH-PULL OSCILLOSCOPE KIT MODEL 425K



THE LOWEST-PRICED 5" SCOPE
IN THE WORLD!

- A SUPER WORKING TOOL FOR TV-RADIO SERVICING, LABORATORY, PRODUCTION-LINE, AND HAM

Model 425K
\$44⁹⁵



Features push-pull output stages in both V & H amplifiers for balanced V & H deflection; wide band TV servicing; wide frequency range, linear, stable sweep; dual potentiometer controls for full screen V & H centering; intensity (Z-axis) modulation input for sweep blanking or insertion of timing markers on the trace; direct connections to deflection plates available at rear of cabinet; provision for internal and external synchronization; shielded transformer operated circuit; calibrated graph screen.
 Specifications: Vertical — 5 cps to 500 kc usable to 2.5mc response, .05 to .1 volts RMS/inch sensitivity, 1 megohm input impedance. Horizontal — 5 cps to 500 kc frequency response, .05 to .15 volts RMS/inch sensitivity, 1 megohm input impedance. Multi-vibrator with range of 15cps to 75kc for sweep. Uses 2-5Y3, 2-6J5, 3-6SN7, 1-5BP. For 105-125 volts AC, 50/60 cps, 68 watts. Lifetime satin finish deep-etched aluminum panel, rugged grey steel case. Size: 15" H, 8 3/4" W, 17 3/4" D. Shpg. wt., 30 lbs.
EICO MODEL 425K — Kit, Complete Net 44.95
MODEL 425 — Factory Wired Net 79.95



Lifetime Service Guarantee



IN ADDITION TO THE REGULAR RMA GUARANTEE ON PARTS, ANY EICO INSTRUMENT MAY BE RETURNED TO THE FACTORY ANY TIME DURING ITS LIFETIME FOR REPAIR AND CALIBRATION AT A NOMINAL CHARGE.



New!
Model 460K
\$79⁹⁵
EICO

DC WIDE BAND 5" OSCILLOSCOPE KIT MODEL 460K

- COLOR AND BLACK & WHITE LAB AND TV SERVICE SCOPE
- 5 MC BANDWIDTH AND DC AMPLIFIERS!
- ENGINEERED FOR THE PROFESSIONAL WITH A LIFETIME GUARANTEE!

Flat from DC to 4.5 mc for reproduction of 3.58 mc sync burst and oscillator signals in color sets. Vertical amplifier direct coupled, and push-pull throughout. High vertical sensitivity, 25 millivolts per inch. Direct or capacitive coupling. Balanced or unbalanced inputs. Accurate and direct peak-to-peak voltage measurement. Automatic sync line voltage measurement automatically. Pre-set TV V and H sweep positions (30 cps and 7875 cps). Edgelit filter lucite graph screen with dimmer control. Vertical Amplifier has frequency-compensated attenuation by factors of 1, 10, 100, and 1000; 0.06 microseconds rise time; 8% or less overshoot; 3 megs shunted by 35mmf input impedance; instantaneous, drift-free positioning. Horizontal Amplifier has 1 cps to 400 kc response; 0.6 millivolts per inch sensitivity; approx. 5 megs shunted by 35 mmf (at 1KC) input impedance; attenuator low impedance type in cathode follower output. Sweep Frequency — 10 cps to 100 kc, plus low frequency sweep with external capacitor.

Uses 5U1 CRT, 2-6AU8, 2-6CB6, 1-12AU7A, 2-6J6, 1-6AX5, 1-1V2 tubes. Excellent mechanical construction and layout so that it can be built at home without special equipment or special knowledge. For 105-125 volts AC 50/60 cps. Deep-etched satin aluminum panel, grey wrinkle steel cabinet. Sizes: 13"W, 8 1/2"H, 16"D. Shpg. wt., 30 lbs.
EICO MODEL 460K — KIT, complete Net 79.95
MODEL 460 — Factory Wired Net 129.50

New! 20 WATT HIGH FIDELITY AMPLIFIER KIT MODEL HF20K



Model HF20K **\$49⁹⁵**

- ±0.5 db 13 to 35,000 cps; ±1.5 db, 7 to 50,000 cps
- COMPARES WITH MOST EXPENSIVE AMPLIFIER MADE!
- BEST BUY IN SUPERLATIVE HIGH FIDELITY AMPLIFIERS!

High quality equalizer and control section plus 20 watt Ultra-Linear Williamson-type power amplifier. Low distortion feed-back equalization; 5 equalizations provided for LP's and 78's including RIAA. Variable turnover, low distortion feed-back tone controls. "Flat" positions at center settings of control knobs. Loudness control and separate level set control both on front panel. Provides adjustable Fletcher-Munson compensation or no compensation when desired. Loudness control can be adjusted to give desired listening level without affecting tape output. Permits use of up to 30 ft. of cable. Six inputs: 4 high level switched inputs — Tuner, TV, Tape, Auxiliary (crystal/ceramic phono or second tuner); 2 low level inputs (not switched) — provides proper pick-up loading and attenuation for all leading magnetic, FM and high quality crystal cartridges without changing resistors. Hum balance control for balancing out 60 cycle residual hum. Power Consumption: 110-120 volts, 60 cps, 100 watts. Tubes: 2-12AX7, 2-12AU7A, 2-6L6GB, 1-5U4GB. Handsomely styled to eliminate the necessity for cabinetry. Size: 8 1/2" H, 15" W, 10" D. Shpg. wt., 24 lbs.
EICO MODEL HF20K — KIT, Complete Net 49.95
MODEL HF20 — Factory Wired Net 79.95
ENCLOSURE FOR HF20 Net 4.50

Lafayette Radio

Write for

FREE



CATALOG

THE WORLD'S GREATEST RADIO, TV and HI-FI CENTER

LAFAYETTE RADIO, Dept. R-1-3, 100 SIXTH AVE., NEW YORK, N. Y.

Ship me the following

Quantity	Description	Model No.	Price

\$..... enclosed. For parcel post include postage (express is shipped collect).

Name _____
 Address _____
 City _____ Zone _____ State _____

order now!

SPECIAL! 2" WESTINGHOUSE \$5.95
0-50 Microamp Panel Meter....

OIL CONDENSER .001 15,000 VDC
3.5 MFD 2 for 89c Ceramic Condenser
1000 VDC for 2 for 99c Low-loss

WESTERN ELECTRIC **FREQUENCY METER**
Stepping relay 44 steps, 6-12 Volt coil..... \$5.95 FRAHM 58-62 CPS, 3" round..... \$11.95

FILAMENT TRANSFORMER **SENSITIVE RELAY**
25 Volt @ 5 amps DPDT, 6500 ohm, 5 MA. ea. \$1.39
Pri 110 V. 60 cy..... \$5.95 10 for \$11.50

2 Mfd 4000 VDC **1 1/2 INCH SQUARE METER**
Oil Condenser Ceramic Ins. High accuracy..... \$3.95
\$2.95 ea. 2 for \$5.90

STANDARD POWER TRANSFORMER
1000 Volt CT at 250 ma., 6.3 volt at 4 amp., 8.3 volt at 3 amp., 5 volt 3 amp. Pri. 110 volt, 60 cy. Full case. Brand new. Price..... \$4.95
2 for \$8.95

WESTERN ELECTRIC **FILAMENT TRANS.**
4 quadrant phase shift capacitor. \$14.75
#D150734.. \$14.75
6.3 Volts @ 8 Amp & 6.3 Volts @ 1 amp. 110 V. 60 cycle Pri. \$1.39

1" Milliammeter **1" Microammeter**
Mounts into 1" hole. 10 mill basic, easily shunted to other ranges. Free shunt wire. Your choice. 0-10 ma. \$3.95
0-200 microamps. Same type as 1" milliammeter. Mounted in rubber casing which may be removed if desired. \$5.95

H. D. 12 VOLT DYNAMOTOR
500 volts output at 400 ma. Mounted on filter base with fuses, starting relay, etc. Has switch for 24 volt operation also. DM49AX. Brand New..... \$17.95

G. E. RELAY CONTROL
(Ideal for Model Controls, Etc.)
Contains a sigma midget 8,000 ohm, relay (trips at less than 2 MA), high impedance choke, bi-metal strip, neon pilot and many useful parts. The sensitive relay alone is worth much more than the total low price of..... \$1.25 Each 10 for \$9.90
FREE Model Control Book With Purchase of 10.

COAX ANTENNA SWITCH
RF relay with low loss ins. Switches to either of 2 type 8318 coax receptacles. Latching device removes voltage after actuated, permitting operation from 12 volts DC to 115 AC. Mounted in aluminum case. Terrific Value. \$1.95
2 for \$3.50

12-14 VOLT DYNAMOTOR **MALLORY VIBROPACK**
375 Volt ... \$1.75
with Filter ... \$1.75
12 Volt Input. 200 Volt at 100 Ma. Out. Small Size \$4.95

MOBILE DYNAMOTORS
5.5 to 6 VOLT DC INPUT
INT. CONT. FILTER PRICE
400 VDC 275 Mills 175 Mills with \$19.95
400 VDC 300 Mills 200 Mills less 14.95
425 VDC 375 Mills 275 Mills less 24.50
11.5 to 12 VOLT DC INPUT
400 VDC 275 Mills 175 Mills with 12.95
625 VDC 225 Mills 175 Mills less 11.75

PANEL METERS
WESTON, G.E., SIMPSON, etc.
2" METERS 3" METERS
0-100 Microamp. \$4.95 0-1.5 Milliamp. \$2.95
100-0-100 Microamp. 4.95 0-10 Milliamp. 2.95
0-150 Microamp. 4.50 0-150 Milliamp. 3.95
0-4 Amp RF 2.95 0-200 Milliamp. 3.95
0-1 Milliamp. 3.95 0-300 Milliamp. 3.95
0-1.5 Milliamp. 2.95 0-500 Milliamp. 3.95
0-5 Milliamp. 2.95 0-150 Volts AC. 4.95
10-0-10 Amp DC. 2.95 DB 0 to +15. 2.95
DB 0 to -15. 2.95 0-300 Volt AC. 3.95

OIL CONDENSER BARGAINS
1 mfd 600 VDC. .25 6 mfd 1500 vdc. \$1.95
2 mfd 600 VDC. .45 10 mfd 1400 vdc. 2.50
4 mfd 600 vdc. .75 2 mfd 2000 vdc. 1.50
8 mfd 600 vdc. .95 3 mfd 2000 vdc. 2.25
10 mfd 600 vdc. .99 4 mfd 2000 vdc. 2.95
1 mfd 1000 vdc. .60 1 mfd 3000 vdc. 1.85
2 mfd 1000 vdc. .75 3 mfd 4000 vdc. 4.95
4 mfd 1000 vdc. 1.25 8 mfd 600 vdc. 1.35
8 mfd 1000 vdc. 1.35

BIG BARGAINS IN LITTLE TYPE
Kit of 25 WIRE WOUND RES. 5 to 50 watt. \$1.95
Kit of 10 TRANSMITTING MICAS. 1.00
9 Ohm 100 watt Non-inductive resistors. 6 for 1.45
100,000 ohm, 100 watt bleeder res. .2 for .89
.0004 2500 V DC MICAS 10 for .99
500 MMF CERAMIC CONDENSERS. 10 for .50
6-12 VOLT DC RELAY DPDT. .79
JENNINGS Vacuum Cond. 12 MMF 20 KVDC. .95
MIN26 Direction Finder. LIKE NEW with tubes. 12.95
FLS RANGE FILTER. .69
15 MEG 1% METER MULTIPLIER. 1.49
ADVANCE 10,000 OHM COIL, 3MA. 1.95
1 MFD 400VDC OIL COND. 10 for .95

Min. Order \$3.00—25% with order F.O.B. New York
10 DAY GUAR. PRICE OF MISE. ONLY

POST ELECTRONICS COMPANY
73 BARCLAY STREET, NEW YORK 7, N. Y.
Phone Worth 4-2526

SIMPLIFYING TONE CONTROL CIRCUITS

By HAROLD REED

Research and Engineering, U. S. Recording Company

Details for constructing a bass boost-bass cut, treble boost-treble cut, dual-type tone compensating circuit.

IN THE schematic diagrams of audio amplifiers, tone control circuits often appear complex and difficult to understand. Like any other electronic network, the circuit can be broken down from the seemingly complex configuration to simple equivalent circuits and then analyzed and the function of each component part clearly visualized.

Actually the simple circuit of the coupling capacitor from the plate of one stage of a voltage amplifier to the grid of the following stage, in conjunction with the grid resistor of the driven stage, affects the tone or frequency response of the amplifier. This circuit is shown in Fig. 1A and redrawn for analysis in Fig. 1B.

It can be seen that C and R constitute a voltage divider network and that the voltage available to the grid of V_2 is that which appears across R . Neglecting the internal capacitances presented by the tubes and wiring capacitances, the voltage across R which is available to V_2 , can be found by solving the equation $E_o = E_i [R/(R+X_c)]$, where X_c is equal to $1/2\pi fc$ and f is the frequency in the audio range being considered. This gives the approximate value of E_o . To find the absolute value,

still ignoring circuit capacities, we cannot combine R and X_c by simple addition. The absolute value is equal to the equation, $E_o = E_i (R/\sqrt{R^2 + X_c^2})$. If the values of C and R are properly chosen there will be little attenuation at the selected reference frequency in the audio band, say between 400 and 1000 cycles. It can be seen from the equation of Fig 1B that this is a low-frequency, or bass-attenuation, network. As the frequency of the signal from V_1 increases, the reactance of C decreases and a greater portion of the total value of E_i appears across R and the grid of V_2 . With decreasing frequency of the signal from V_1 , the reactance of C increases, causing less of the signal voltage, E_i , to appear across R and the V_2 grid. In other words, there is a greater voltage drop across C at the lower frequencies. The attenuation in decibels is equal to $20 \log E_o/E_i$ or may be found by using the equation $db = 10 \log [1 + (f_i/f)^2]$, where f_i is the reference frequency at which R and X_c are equal and f is the operating frequency or frequency at which the test is being made, referred to f_i .

Suppose we now reverse the positions

Fig. 1. (A) Frequency-sensitive circuit found in most commercial amplifiers. (B) Equivalent circuit redrawn for analysis. (C and D) Variations of circuit of (A).

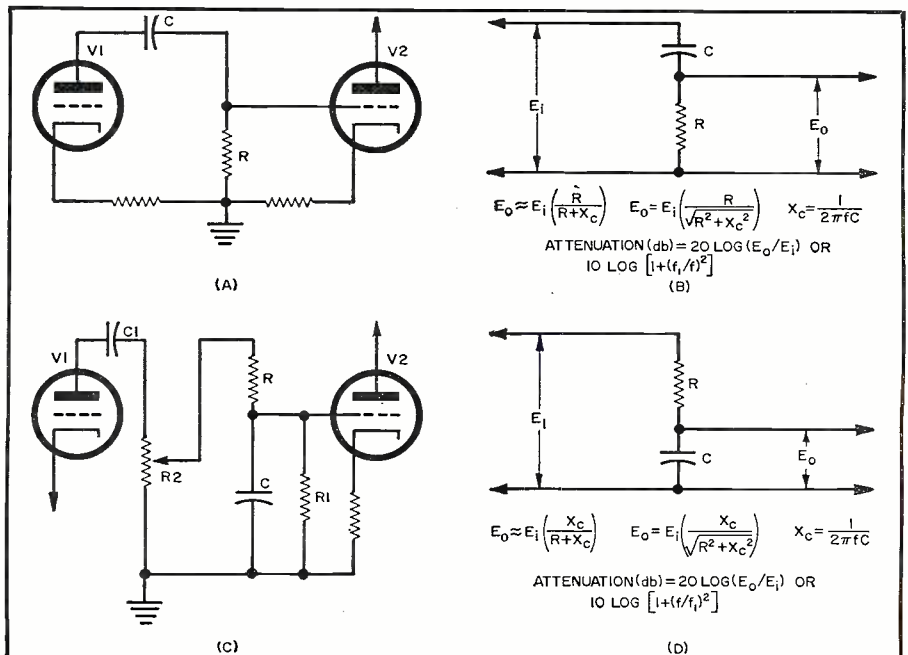

OLSON RADIO FOR GREATEST BUYS IN RADIO AND TV SUPPLIES

The Royal Monarch AUTOMATIC RECORD CHANGER



Crystal Model
REG. LIST \$69.95
REG. WHOLESALE
PRICE \$41.97

LOTS OF 3
EACH \$25.00

Single, ea. \$27.50

Stock No. RP-5
Equipped with dual crystal turnover cartridge with 2 sapphire needles.

The Only Record Changer to Carry Exclusive Gold Crown Guarantee: Fully Guaranteed for ONE YEAR against failure. This includes the motor, cartridge and every moving part. If the "Monarch" Changer should fail for any reason, Olson Radio Warehouse will repair or replace the entire unit FREE.

3-SPEED
Made in England
TWO MODELS
VARIABLE RELUCTANCE MODEL

REG. LIST \$79.95
REG. WHOLESALE
PRICE \$47.97

LOTS OF 3
EACH \$30.00

Single, ea. \$32.50

Stock No. RP-6
Equipped with a GOLD PLATING 500 turnabout Magnet (Variable Reluctance) Cartridge with 2 sapphire needles.

"The Changer that obsoletes all other changers" • Plays Intormised 7-10-12" records • "MAGNETIC" selector enabling 7", 10" and 12" records to be automatically selected and played at 33 1/3, 45 or 78 rpm • TEN record capacity—INTERMIXED in any order • Pick-up automatically returns to rest and motor switches itself off after last record • Reversible dual sapphire stylus cartridges full tonal range to over 10,000 cps • "Rotocom" equipped. Control for ON-OFF, REPEAT • Turntable heavily weighted, covered with rubber mat and runs in friction-free Ball Bearing Race • Oversize 4-pole induction motor • Base is mounted on suspension springs. Shpg. wt. 15 lbs.

MONARCH MOUNTING BASE. Top is cut to fit the "Monarch" Changer. Mahogany finish. Size approx. 14 x 12 x 3 1/2". List price \$8.50. Shpg. wt. 5 lbs. \$4.25 ea.

GENERAL ELECTRIC S1201A



HIGH FIDELITY
12" SPEAKER

Stock No. S-184
\$14.99

DELIVERS 25 WATTS
FAMOUS GE MODEL S-1201A

Highly recommended by famous consumer research organizations. Reg. List \$33.25. Provides clean, smooth frequency response over the range from 50-13,000 cps. Alike 5 magnet weighs almost a FULL POUND and is guaranteed to deliver bass and treble notes distinctly. Non-varying 1 1/4" aluminum voice coil. 25 watts. Impedance 8 ohms. Operates perfectly on any Radio, TV or Amplifier. Shpg. wt. 12 lbs.

"GOLDEN GATE" 8" SPEAKER



With "Whizzer"
Sound Dispenser

Stock No. S-229
List Price \$12.00
Olson's Price, Ea. 2 for \$9.50

Finely finished in all gold lacquer. Dealers, order these speakers for installation where space is a factor. Will outperform many 12" units. Employs two concentrically mounted cones for extremely smooth reproduction at high or low volume. Small cone in center of large cone is called a "Whizzer" and provides extended treble response, good overall balance and wide dispersion angle. Equipped with heavy Alnico 5 magnet and cover. Power handling capacity 8-10 watts. Response 40-12,500 cps. Speaker cone 8" diameter, voice coil 8 ohms. Shpg. wt. 5 lbs.

TELEPHONE SET



Sound Powered
Includes Headset
and Microphone

Stock No. M-98
\$3.95 SET

2 Sets for \$7.50

Brand New—original cost \$30.00. No batteries needed—self powered. Permits 2-way talking up to 2 1/2 miles over any two-way conductor. Each set contains a pair of sound powered high impedance dynamic headsets with felt padded rubber cushions and leather covered head-band. Both microphone and earphones have cone diaphragms and are extremely rugged and sensitive. Units may be removed from headsets to make efficient high powered miniature speakers. Useful for Antenna installations where bending of antenna is critical. Shpg. wt. 5 lbs.

COMBINATION RADIO AND TAPE RECORDER



Complete Continental Outfit
as Shown
\$96.50 DISCOUNT IF YOU ORDER NOW

HERE'S WHAT YOU GET

- Reg. Price
- Continental Recorder-Radio Combination with Crystal Microphone, Cable & Plug. \$189.95
 - All Steel Tape Chest (Holds 12 Reels) 4.95
 - 5—1200' Reels Plastic Tape.. 17.50
 - 5—7" Steel Cans for Tape... 4.00

OLSON BEST BUY!
Total Value . . . \$216.40
YOUR DISCOUNT . . . 96.50
YOUR COST . . . \$119.90

Now! Make Recordings Right Off the Air

ALL THIS FOR ONLY

\$119.90

STOCK NO. AM-20
EXCLUSIVE FEATURES

- Built-in Radio • Only 3 Controls
- TWO Speeds 33 1/3" and 7 1/2"
- Plug-in Head • 40-18,000 cps response
- 4 Pole Fan Cooled Motor
- Die Cast Construction • Tone and Volume Controls • Neon Level Indicator • Separate Inputs • Separate Outputs • Plug-in AC Cord.

covers the full broadcast range and without any antenna. The Portable case is attractive washable vinyl. Operates on 110-120 V. AC 60 Cy. Packed in factory sealed cartons. Shpg. wt. 40 lbs.

If you don't have a recorder, order this outfit. It's a "BEST BUY." If you do have a recorder, here is an ideal system—order this Continental and use your old recorder for a spare—or sell it. An ad in your local newspaper will bring you quick buyers. Recorders are very much in demand.

HI-QUALITY RECORDING TAPE

PLASTIC BASE
1200' on 7" Dia. Reel

Stock No. X-249
Single, ea. . . . \$2.19
Lots of 6, ea. . . . \$1.79

This famous brand tape regularly sells for \$5.50—but Olson gives you a 71% discount. Perfect in every respect, this quality tape is famous for its low noise level and uniform output. Freq. response 30-15,000 cps—red oxide base—1/2" wide. Reg. \$1.25 seven inch plastic base—1/2" wide—fits all recorders. Stock up now during this Giant Sale and get the Tape Buy of Your Life. Shpg. wt. (one doz.) 10 lbs.

NEW L-O-N-G-E-R PLAY

1800' TAPE ON 7" REEL

Stock No. X-583
Single, ea. . . . \$2.99
Lots of 6, ea. . . . \$2.59

50% more recording time on a 7" reel. Shpg. wt. (one doz.) 10 lbs.

JACK AND CONTROL BOX

1c SALE
Stock No. SW-62

79c ea.

GET ONE MORE FOR ONLY . . . 1c

Yes, it's true! Order one at just 79¢ and get another for only 1c. This handy Jack and Control Box is a genuine Signal Corps No. BC-1366. Rare bargain for experimenters. Two piece cast aluminum box 3 1/4 x 4 1/2 x 2 1/2". Contains 2 phone jacks, 5 position relay switch with one spring return position, eleven contact male and female contact board with silver plated terminals and 2 knobs. Shpg. wt. ea. box 1 lb.

TELEGRAPH KEY

Stock No. X-606
89c ea.

Silver contacts, brass hardware. Adjustable. Permanent mounting. Shpg. wt. 1 lb.

Never, ever before! Make never ever again—Olson offers the new 1958 Continental Tape Recorder with a BUILT-IN 6-tube powerful superhet radio. Here is quality, here is fidelity, here is simplicity of operation and most important, here is trouble-free recording. Only three controls—no push-buttons to go haywire and create noise. Record your favorite music operas, pop tunes, classics, etc. directly from the built-in superhet radio and stop buying expensive records. You can also record your voice or music right with that push-button recorder. Radio may be used without recording, too. Or you can make recordings with the mike, only. Equipped with separate inputs for microphone and radio or TV or phonograph (for copying records) and separate outputs for 2 different sound systems. Has exclusive Plug-in Head and Tape Guide Sliding to assure PERFECT Tape Head Alignment. Records at 3 3/4" and 7 1/2" per second. Records up to 3 hours on one.

This Recorder has full tone and volume controls and takes both 3" and 7" reels. Wow and flutter less than 1%. High fidelity amplifier has flat response 40-18,000 cps. Motor is 4-pole fan-cooled constant speed shaded type. Top panel and frame work is DIE-CAST, rugged and warp-proof. Crystal mike is especially sensitive and is equipped with shielded cables. Has exclusive Neon indicator controls recording level. The radio on 2 flashlights and is handily used and rugged. Covered with attractive washable vinyl.

NEW CRYSTAL SET KIT

Stock No. KB-1
\$1.50 KIT

Uses GS Germanium Diode
Easily assembled by even a child in minutes. Contains variable iron core tuned coil and knob, bypass condenser, variable capacitor, 1N34 General Electric Diode Detector, phone clips and transparent hinge case. Covers complete frequency range from 400 to 3000 KC which permits reception of local weather stations, aircraft beacons, standard broadcast, police calls, amateur and many others. Unique design still permits complete coverage of standard broadcast only if desired. Replaced complete with all parts and detailed illustrated instructions, less only wire and solder. For best results use headphones. Shpg. wt. 2 lbs. 2000 OHM DOUBLE HEADSET—Stock No. X-542. Pr. \$1.95

COMPLETE TV ANTENNA KIT

"SNAP-UP"
PREASSEMBLED
Stacked Conical

Stock No. AA-15
\$9.99

COMPLETE ANTENNA KIT. NOTHING MORE TO BUY. Olson's outstanding value—All Aluminum—All VHF Channel. Contains everything you need to put up a professional installation: 12-element conical bays with stacking bars, (21-5" mast sections, 1" mounting base, 150' 300 ohm lead-in, all necessary standard insulators and hardware. Easy to install. New Pre-assembled "Snap-Up" Type Antenna—No loose rods and parts. Shpg. wt. 15 lbs.

Monarch 3-Speed Photo Motor

New—Different—Better—Made in England. Hand-built by Old World Craftsmen who take pride in precision equipment. Easy shift from one speed to another—331 1/2, 45 and 78 RPM. Plus neutral position. Grooved rubber foot controllable. Includes 45 Spindle Adapter. Shpg. wt. 5 lbs.

Stock No. MC-1
\$5.99 Ea.
3 for \$15

NO GHOST ELECTRONIC TV ANTENNA



Regular List \$7.95 • New—Different—Really Good FOR VHF TV AND AM-FM RADIO

Stock No. X-526
\$1.99 3 for \$5

ELIMINATES GHOSTS—SNOW—DRIFT—FUZZ—FLUTTER AND INTERFERENCES. Contains variable tuning circuits with calibrated visual indicator. Its ten position circuit resonates the impact circuit to bring in the strongest, clearest signal and traps out unwanted electrical interferences. Eliminates rabbit ear antennas. Operates independently as indoor antenna; in conjunction with roof antennas or any other air antenna. Concealed anywhere. Shpg. wt. 2 lbs.

DETECTIVE TYPE CRYSTAL MICROPHONE UNIT

Now you can record or listen to conversations without detection. Use with any amplifier. A real high impedance crystal mike. Never before offered to experimenters. Ideal for hidden microphone work. Used by detectives. Weighs only 1 ounce. Extremely sensitive. 2" dia. crystal level—5 dB. Omni-directional pickup pattern. With solder lug terminals so that any shielded cable can be attached. Works well when hidden behind pictures, under a desk, etc. Shpg. wt. 1 lb.



Stock No. M-99
\$1.99 3 for \$5.00

Brand new in factory sealed cartons. Original cost \$32.00. Contains a wealth of valuable parts including 50' dia. crystal level—5 dB. 3 1/2" tube socket, condensers, resistors, 4 jacks, input and output transformers, battery holders, etc. For operation on 2 flashlight cells and one 67 1/2 volt battery.

INTERPHONE AMPLIFIER

Signal Corps
No. BC-709
Stock No. AM-15
\$1.99 Special 3 for \$5.00

Attention: Schools, Clubs, large Dealers—write for quantity.

Ready to operate or can be rewired for many other uses, such as baby-sitter amplifier, 3V or 6C recorder, transceiver, crystal set audio amplifier, etc. The polished aluminum case alone is worth more than the \$1.99. Get yours now, while they last. Circuit diagram and instruction book included. Shpg. wt. 7 lbs.

SHOCK MOUNTING ASSEMBLY FOR AMPLIFIER

Stock No. X-574, each. 49c

NEW! SUN BATTERY

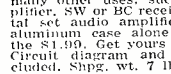

Convert Sunlight to Electric Current

Stock No. RE-1
Reg. \$2.50
EACH ONLY \$1.50
3 for \$4.00

Sunlight striking selenium layer of cell generates 2 MA under a 10 ohm load. 60 microamps current output is generated at 100 foot candles with a 55 ohm load. Can be connected to any milliammeter and used as a light meter. Any number of these cells may be connected in series or series-parallel to increase voltage and current. Size 3/4 x 1 1/2. Open circuit voltage 0.50. High resistance. 67 leads for automatic light dimming, counting, burglar alarms, light meters, and countless interesting experiments. With full instructions, indefinitely—will not wear out. Shpg. wt. 1 lb.

6 VOLT DC MOTOR

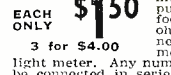

Stock No. MO-3
\$1.19 3 for \$3.50

Reg. \$7.50. New Delco Motors designed for automobile heaters. 1/40th HP. For portable shop equipment, lab use, experiments, school projects, etc. Quiet—3500 rpm. Shaft length approx. 1". Motor size 2 1/2 dia. x 4". Shpg. wt. 3 lbs.

HOW TO ORDER

Mail your order to 281 E. Market St., Akron 8, Ohio. Send remittance with order (add for postage 5c for each dollar's worth ordered—10c for three dollar's worth if you are more than 1000 miles away). OLSON REFUNDS EVERY CENT NOT CASHED. Or—send no money—we'll ship C.O.D. and you pay mail or expressman for merchandise and postage. ALL MERCHANDISE 100% GUARANTEED. PLEASE SEND ORDER \$5.00.

SEND FOR NEW FREE CATALOG

SEE YOUR OLSON CATALOG FOR COMPLETE LISTING OF BARGAINS ON THOUSANDS OF NATIONALLY ADVERTISED ITEMS.

OLSON BARGAIN STORES IN:

- CHICAGO—623 W. Randolph St.
- CLEVELAND—2020 Euclid Ave.
- PITTSBURGH—5918 Penn. Ave.
- MILWAUKEE—423 W. Michigan
- BUFFALO—711 Main Street

AMERICA'S GREATEST TUNER BUY!

The Sensational **Granco** FM TUNER



Amazing \$34⁹⁵*
Value... ⁱⁿwalnut

Compare its performance with high priced tuners
**PROVIDES ENDLESS HOURS OF STATIC-FREE
AND DRIFT-FREE FM LISTENING PLEASURE**

The perfect addition to any HI-FI system,
TV set, phonograph or tape recorder!

- Model T-160
- Frequency Range: 88-108 Mc.
 - Selectivity: 200 Kc at 3 db points.
 - Audio Frequency Response: 20 cps to 20,000 cps.
 - Sensitivity: 4 microvolts for 20 db quieting.
 - Coaxial Tuner: Exclusive Granco feature assures drift-free reception.
 - Hum Level: 70 db below 1 volt.
 - Maximum Audio Output: 2 volts.
 - Antenna Input: 300 ohms or built-in line cord antenna.
 - Overall Dimensions: 7" w. x 5" h. x 4 3/4" d.

ASK YOUR DEALER FOR A DEMONSTRATION

See and hear Granco's FM and FM-AM table radios
and high fidelity radio-phonograph combinations

*Price slightly higher,
in West and South

For name of your nearest dealer, write

GRANCO PRODUCTS, INC.

36-07 20th Ave., Long Island City 5, N. Y.

World's only manufacturer specializing in FM

VIDEO PROBE METER

a professional instrument
designed for testing a T.V.
ABOVE and BELOW
chassis!

THE VIDEO PROBE METER!

Saves TWO HOURS PER
DAY when used in shop for
under chassis work.



With the attachable pick-up loop, (where sufficient signal is available) the Probe Meter can detect and indicate radiation of signal thru I.F. and video amp tubes. (Simply slide loop over tube being tested.) Where internally shielded tubes are encountered, remove tube and insert probe tip into grid pin of socket. Indicates gain per stage.



List Price
\$31.50

Can accurately trace and indicate the following T.V. circuits, — (from tuner to pix tube) R.F., I.F., Det., Video, Sync., local osc., Hz. osc., Hz. Drive, audio output, sound I.F. (Signal tracing radios.)

EXCELLENT FOR TRACING AND COMPARING
COLOR T.V. CIRCUITS.

ADDITIONAL FEATURES

Voltmeter, 0-500V. D.C., 20,000 Ohms/volt.

Fully Guaranteed

If your dealer cannot supply you, order direct full purchase price refunded if not satisfied.

DEALERS & REPS. INQUIRIES WILL RECEIVE IMMEDIATE ATTENTION.

Research Inventions & Manufacturing Co.
617 F St., N. W., Washington 1, D. C.

LEARN TV SERVICING UHF—COLOR—VHF

Master the latest, up-to-the-minute
TV and Color TV developments.

You can Earn to \$5,000-\$10,000 a year in TV servicing after a few short months. Education or age is no barrier. Find out how you can EARN WHILE YOU LEARN in our big Shops and Laboratories. You work with the latest equipment. Waste no time with Non-Essentials, Math or Design Theory. Complete information in our new FREE booklet. Address Dept. 3-56-R. Approved for veterans. Free Placement Service.

WESTERN TELEVISION INSTITUTE

341 W. 18th St. Los Angeles, Calif.

Dept. 3-56-R

Mail me information about training.

Name

Address

SELENIUM RECTIFIERS

75 ma \$.49	150 ma \$.74	300 ma \$ 1.19
100 ma .62	250 ma 1.08	500 ma 1.42
100 ASSORTED TUBULAR CONDENSERS..	3.64	
100 ASSORTED 1/2, 1 & 2W RESISTORS..	1.25	
ALNICO PM SPEAKERS 4"—\$1.17, 5"—1.29		
50L6 OUTPUT TRANSFORMER \$.39, 6K6— .49		
21" TV CONVERSION KIT	\$13.97	
27" TV CONVERSION KIT	15.98	

Send For Free Catalog

Capital Electronics, 222 Fulton St., N. Y. 7, N. Y.

NOW IN STOCK at TV PARTS, INC.

2169 Coney Island Ave.
Brooklyn 23, N. Y. • ES 6-2292



COLOR & BLACK & WHITE
5" — 5 MC SCOPE

KIT \$79.95 Wired \$129.50



#460

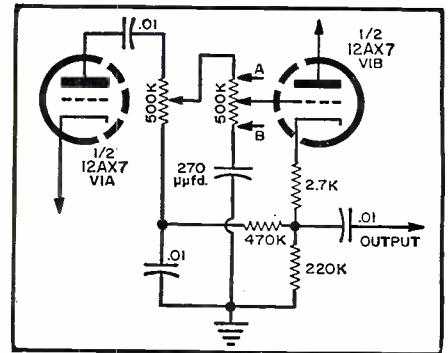

Fig. 2. Practical application of the circuit discussed theoretically in Fig. 1C.

of R and C as shown in Figs. 1C and 1D. C_1 is the usual interstage coupling capacitor and R_1 the grid resistor of the following stage. This is the familiar type of tone control for high-frequency, or treble, attenuation. The 500,000 ohm potentiometer, R_2 , is the volume control.

The equation $E_o = E_i [X_c / (R + X_c)]$ applies and R and C still constitute a voltage divider network, but E_o appears across C instead of across R as occurred in the previous arrangement. Now, at low frequencies, the reactance of C becomes high and the greater portion of E_i appears across C and the grid of V_2 . The signal voltage to V_2 is then determined primarily by R and the grid resistor R_1 . As the frequency of the signal from V_1 is increased, the reactance of C becomes smaller and smaller and less of the signal voltage appears across C and the grid of V_2 . The resistance, R , is usually made variable so that attenuation at the higher frequencies can be varied. For instance, if R consists of a 500,000 ohm potentiometer and C is a 270 μ fd. capacitor, the attenuation from the reference point is variable, depending upon the setting of R which varies the ratio of X_c to R . Loss in db is again equal to $20 \log (E_i/E_o)$ or to $10 \log [1 + (f/f_c)^2]$.

As an example, this network as used between the triode sections of a 12AX7 with the output section functioning as a cathode follower, as shown in Fig. 2, the actual measured attenuation with the component part values shown was 2 db at 1000 cycles, 16 db at 8000 cycles, and 24 db at 20,000 cycles when the 500,000 ohm potentiometer arm was at position B. With the potentiometer arm at position A, the amplifier response is essentially flat over the audio frequency band.

Fig. 3. A dual-type tone compensating circuit. Parts specifications are included.

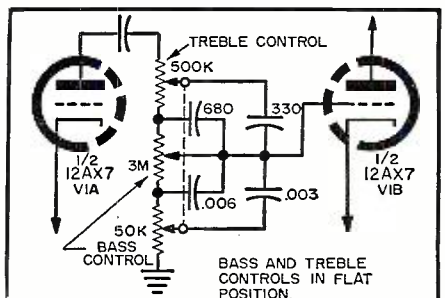

...the long awaited companion
to the famous *Rondine* TURNTABLES

the New

REK-O-KUT TURNTABLE ARM

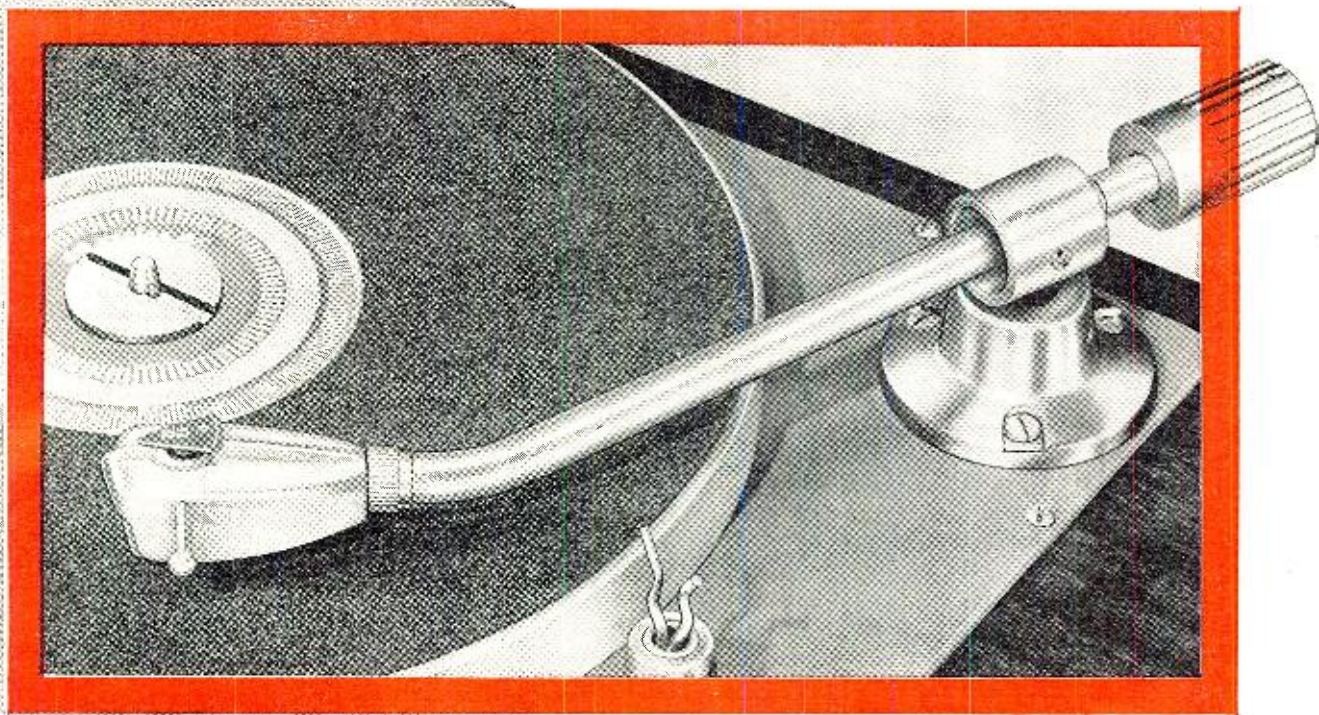

Shown mounted on plate of Rondine Turntable

Among users of fine audio equipment, the name Rek-O-Kut is synonymous with the finest... and the simple announcement of a new Rek-O-Kut development carries the assurance of a superior product.

A reputation such as this is not easily come by. It remains a constant challenge — and must be closely guarded. No Rek-O-Kut product is therefore committed to market unless and until it has first been exhaustively tested and re-tested in the lab and in the field.

The new Rek-O-Kut Turntable Arm is presented with just that confidence — that by its inherent design and demonstrated performance, it will contribute immeasurably to the quality of record reproduction.

The Model 120 is designed for all records up to 12 inches in diameter, and the 160 for records up to 16

inches. Interchangeable plug-in heads accommodate standard cartridges and both arms provide means for precise adjustment of stylus pressure.

Regardless of the turntable you own, the addition of a Rek-O-Kut arm will bring a welcome improvement in performance — this because of better tracking, superior damping and resultant lower distortion and record wear. For those who seek the very ultimate, we earnestly recommend that they consider both — a Rondine Turntable and a companion Rek-O-Kut Arm. We will gladly provide descriptive literature to aid in the making of a selection.

model 120 - \$26⁹⁵ • model 160 - \$29⁹⁵

See your hi-fi dealer or write to Dept. QC-12

REK-O-KUT COMPANY • 38-01 Queens Blvd., L.I.C. 1, N.Y.
Makers of Fine Recording and Playback Equipment • Engineered for the Studio • Designed for the Home

IN CANADA: Atlas Radio Corp., 50 Wingold Avenue, Toronto 10, Ontario EXPORT: Morhan Exporting Corp., 458 Broadway, New York 13, N. Y.



CROWN

Professional Tape Recorder



SPECIFICATIONS

"Micro-Linear" Heads
 Three Speeds
 Three Motors
 Meets NARTB Standards
 "Micro-Sync" Timing
 Straight Line Threading
 4" Dual Lighted Meter
 Magnetism Braking
 Perfect Erasure

★ ★ ★ ★

GUARANTEED
 Record & Playback Performance

IPS	15	7½	3¾
% WOW	.12	.18	.25
DB	±2	±2	±3
CPS	20 to 22,000	30 to 14,000	30 to 10,000
NOISE RATIO	55	52	44

for Full Track Heads

CROWN IMPERIAL

Breaks Sound Barrier! Breaks Price Barrier!

No other recorder at even double the price carries the guaranteed performance and features of CROWN RECORDERS! Heavy construction assures years of perfect performance!

Dual or Full Track \$425
 Complete with case

Write for literature. Address Dept. RN3.

INTERNATIONAL RADIO & ELECTRONICS CORP.

Elkhart Indiana

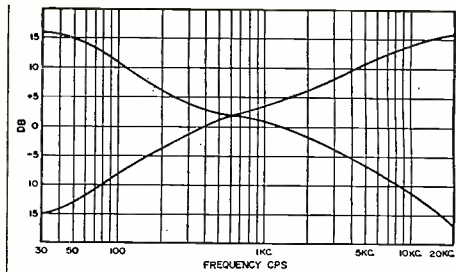

Fig. 4. Curve of the compensating effect of the network shown in diagram, Fig. 3.

High-fidelity amplifiers are usually equipped with controls for boosting or attenuating both the high and low frequencies. A circuit satisfying these operating conditions is given in Fig. 3. It consists of four capacitors, a single 3 megohm potentiometer, and a 500,000/50,000 ohm potentiometer.

It can be seen that this tone compensating network, working between the triode sections of a 12AX7 tube, provided a treble cut of 17 db and a treble boost of 16 db at 20,000 cycles. The bass control effected a bass cut of 15 db and a bass boost of 16 db at 30 cycles. Of course, many variations of these control settings may be employed so that the listener may alter the frequency response of the amplifier to suit his particular taste. A curve of the compensating effect of this network is shown in Fig. 4.

It is beyond the scope of this article to mathematically analyze each possible configuration of Fig. 3. Those interested may break the circuit down into simpler arrangements for study and analysis as explained previously. For instance, Fig. 3, assuming that the arms of the dual controls are exactly at center position of the total resistance of the controls, might be redrawn to give the equivalent circuit of Fig. 5 and so on for each circuit condition. The treatment of dividing networks and filters given by Oliver Read¹ and tone control data by the same author will prove most helpful to those wishing to study the subject more thoroughly.

For the reader interested in constructing the tone compensating network just discussed, parts values are shown. Although dual controls for commercial sound reproducing systems are

Fig. 5. Example of how the various circuits can be redrawn for easy analysis.

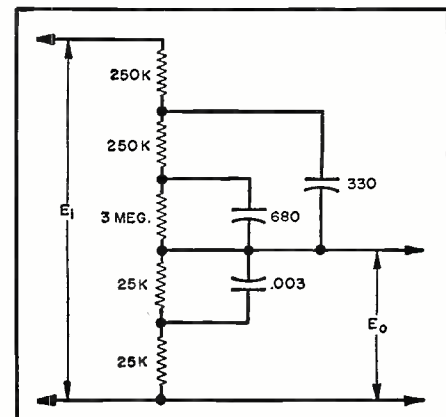

LEARN ELECTRONICS & COLOR TV in K.C.

UNIVERSAL TV . . . Famous for 25 Years
Thousands of Successful Grads



ELECTRONICS—the world's GREATEST new industry is years ahead of its manpower supply. **ELECTRONICS JOBS ARE SEEKING TRAINED TECHNICIANS**, an acute shortage of which exists today. Big companies are actually pirating men from one another because there aren't enough trained electronics experts to go around to fill the many jobs.

Wide Scope Electronics Course at UNIVERSAL:
 Embraces Radio, Monochrome-Television, Color TV, Industrial Electronics, Industrial Television, Atom-electronics and Automation. Automation, a terrific new field, embraced at UTS.

25 Years EXCLUSIVELY in Electronics:
 For a quarter of a century UNIVERSAL TV has been training and placing grad technicians in fascinating big-pay jobs from coast to coast. You can start earning as much as \$150 per week; no limit as time goes on, or you can open your own business.

UNIVERSAL not a Johnny-come lately school:
 Not a home study or correspondence training, but a "genuine" old established resident school staffed by expert instructors and headed by America's first TV broadcasters. Costs so little to prepare yourself for life. Many middle age trainees attend; go into successful business. No previous experience needed. Approved for vets and non-vets. Send coupon for FREE BOOK on TV & electronic opportunities.

WRITE FOR

FREE CATALOG

FILL OUT COUPON

UNIVERSAL TV SCHOOL
 1222X Admiral Boulevard, Kansas City, Missouri

PLEASE SEND ME INFORMATION FREE. Age _____

Name _____

Address _____

City _____ State _____

Check here if Korean Veteran

NEW IMPROVED

Senco

Filament CHECKER



NOW ONLY \$2.75

DEALER NET
With Leads \$2.95

MORE VERSATILE
LOWER COST

- Automatically checks ALL TUBES including locals and pix tube.
- Continuity and voltage tester—no switches, merely plug in test leads.

Ask your Jobber to see the New Senco Checker.

SERVICE INSTRUMENTS CO.
ADDISON, ILLINOIS

"ADDISON INDUSTRIAL DISTRICT"
In Canada: Emerald Television Corp., Montreal

usually designed especially for such applications, the home constructor may build a satisfactory network using the multi-section controls currently listed by *International Resistance Co.* These multi-section controls can be combined with the *IRC* "Q" controls for numerous dual-control combinations. They are attached to the single control in the same manner as an "on-off" power switch is added to a variable control.

REFERENCE

1. *Read, Oliver: "The Recording and Reproduction of Sound," Howard W. Sams & Co., Inc., pp. 361-366 and 385-495.* -30-

VARIABLE CAPACITOR MOUNTS

By ARTHUR TRAUFFER

MOST of the lower-priced, high-capacity variable capacitors have no provision for single-hole-mounting, making it necessary to drill two or three holes in the panel (besides the shaft hole) every time you want to mount the capacitors on vertical panels. One well-known brand 365- μ fd. variable has no mounting holes on the front of the frame at all—there are two holes on the bottom for mounting it on a chassis or breadboard.

As shown in the photo, the writer solved the problem by using standard electrical fixtures selling in dime stores and electrical supply stores for 10c to 15c each. These are brass cup-flanges containing $\frac{1}{8}$ NPT nipples, used for mounting brass-shell lamp sockets onto walls, ceilings, etc. To convert a variable capacitor to single-hole-mount, simply slip the flange over the shaft and onto the front of the capacitor frame, and then fasten the flange securely with machine screws, rivets, or solder.

Both variables shown in the photo are well-known makes now on the market. The one on the left has no panel-mounting-holes on the front of the frame at all. The flange was reamed out slightly (a rat-tail file can be used) and then slipped onto the shaft, and then two holes were drilled through the front of the capacitor frame and threaded with a 6-32 tap, then the flange was secured to the capacitor frame with two 6-32 round-head screws $\frac{3}{16}$ " long. If you don't want to thread the holes just use a larger drill and use hexagon nuts on the screws. Or if desired, simply solder the edge of the flange to the front of the capacitor frame. In this case, the entire flange was used because the shaft was long enough to accommodate a knob after the flange was installed. The capacitor at the right had a shorter shaft so it was necessary to saw the flange in two, midway between the nipple and the flat part of the flange. The flange was then soldered onto the front of the capacitor frame, as shown.

Standard $\frac{1}{8}$ NPT hexagon nuts fit the nipples on the flanges, as shown. -30-

How inexpensive brass cup-flanges can be used to panel mount variable capacitors.

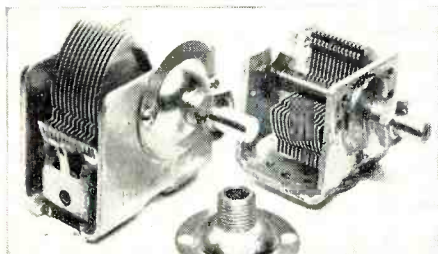

200 lbs. on a 10 ft. television mast



PERMA-TUBE
supports
it safely!

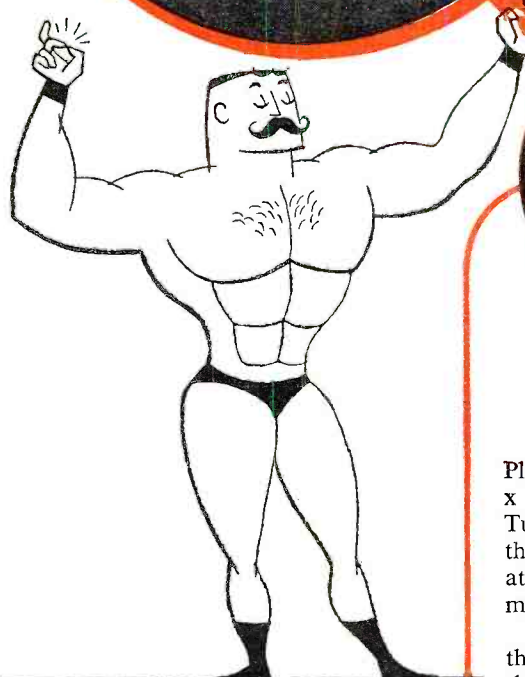

What about
other masts
either steel or
aluminum
?

**MAKE THIS TEST
YOURSELF**

Place a 10 foot length of $1\frac{1}{4}$ " x 16 gage (.065" wall) Perma-Tube between two tables so that 6 inches rests on a table at each end. Stand a 200 pound man at the center point.

What happens? Tests prove that Perma-Tube will support this 200 pound weight with a minimum of deflection and permanent set.

And, Perma-Tube *stays strong* because it is corrosion-proof (Perma-Tube is coated with a metallic vinyl-resin inside and out).

Other steels and the strongest grades of aluminum show serious degrees of permanent set. Why? Because they lack the special strength of J&L Steel that is used to make Perma-Tube Television Masts.

What PERMA-TUBE means to you

1. Protection for your work and your customers.
2. Freedom from damage due to storms or corrosion severe enough to destroy most other masts.
3. Better reception from the sets you install.
4. Insurance for your reputation.
5. Increased good-will and profits for you.



Jones & Laughlin
STEEL CORPORATION - Pittsburgh

Hi-Fi record reproduction requires a **PRECISION** turntable...

THE NEW PRESTO

Pirouette
T-18

MADE BY THE WORLD'S LARGEST MAKER OF PRECISION RECORDING EQUIPMENT

- Improves record performance tremendously...delivers professional broadcast quality!
- Simple operation—a sideways flick of the control lever selects 3 speeds—33½, 45, 78 rpm.
- Quiet insured! Precision deep-well turntable bearing.
- Quality plus! Extra heavy weight, cast aluminum 12-inch turntable covered with non-slip cork.
- Beautiful design—smart telephone black and brushed chrome finish.
- Easy to install...only rectangular cut-out needed. Easy to buy at only \$53.50.



Revolutionary 3-Speed Mechanism
The Pirouette embodies the exclusive PRESTO "flick shift" speed mechanism, with 3 idler wheels mounted on a single movable plate. Insures professional speed accuracy and trouble-free performance.



Presto Pirouette T-18H Turntable
The history-making T-18 with hysteresis motor...a magnificent hi-fi instrument. \$108.



Presto Pirouette T-68 Turntable
The 16" version of PRESTO's flick-shift T-18...for homes with fine hi-fi collections. \$79.50.



Presto Pirouette T-68H Turntable
A 16" flick-shift turntable with hysteresis motor...a new pinnacle in hi-fi. \$134.

Send this coupon for more information →



Export Division: 25 Warren Street, New York 7, N. Y.
Canadian Division: Instantaneous Recording Service, 42 Lombard Street, Toronto

PRESTO RECORDING CORP.
Hi-Fi Sales Division, Dept. RTV-3
Paramus, New Jersey

Rush catalog sheets on the new PRESTO Pirouette T-18, T-18H, T-68, T-68H turntables and name of nearest PRESTO distributor.

Name _____
Address _____
City _____ Zone _____
State _____

terrific TV antenna values at Concord

8-element VEE-D-X "long john" yagi

\$7.95 net **LOTS OF 3 \$7.49 ea.**
Reg. \$18.50

A. High front-to-back ratio provides high gain for fringe areas. Full 6 mc. band width. Rugged boom bracing for extra strength. Chan. 8, 9, 10; Specify Chan. Wt. 6 lbs. Stock #99-T-DL1.

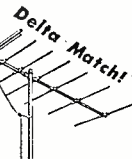

10-element VEE-D-X broad-band yagi

B. 2 Antennas cover all VHF channels. High front-to-back ratios. Pre-assembled for easy installation. Chan. 2-6 Wt. 15 lbs. Stock #99TX26, Reg. \$41 Net \$10.95 Stock #99TX713, wt. 9 lbs., Reg. \$20; Net \$8.95

4-bay VEE-D-X colinear array

\$6.50 net Reg. \$26

C. Broad-band array has attached phasing harness, center terminals for line. Hardware cadmium-plated. Chan. 8, 9, 10, 11, 12, 13. Specify Chan. Wt. 4¼ lbs. Stock #99TVDCA.

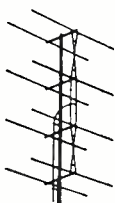

10-element DELCO Yagi

Reg. \$35 **\$7.50 net**
lots of 3 — \$6.95 ea.

D. In-line design with wide element (heavy gauge all-aluminum) spacing for extra-high front-to-back ratio. Twin V-braced crossbar for strength. Chan. 5 & 6. Specify Chan.. Stock #99TBD610.

UHF bowtie & reflector by NEPCO

\$2.65 net **LOTS OF 3 \$2.49 ea.**
Reg. \$6.95

E. For mast mount. High gain & directivity on all UHF bands. Hardware and outfit weather-resistant. Wt. 3 lbs. Stock #T-BTR-1X.

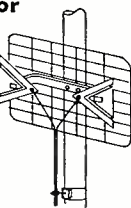

Money-back guarantee.
\$5 minimum orders. FOB NYC. 25% deposit on COD's.

send for FREE catalog

Concord Radio, 47-B Warren St., New York 7

- Please send me items on attached clipping.
- I'm not on your list. Send Bargain Catalogs.
- Send special TV Accessories Close-out List.

name _____
address _____
city _____ zone _____ state _____
 check enc. M.O. enclosed Dlgby 9-1132

Pulling Chassis (Continued from page 57)

In an extreme case like this we have found a complete understanding is best. To take a chassis without spelling out everything in black and white is only asking for heartaches. So, Hank told the gent the price our average bench repair runs. Then he carefully explained, that is only the average. Hank pulled out a list of our bench prices on a card that we carry just for situations such as these. These preparations paid off, for the man gave him the go-ahead.

Sure enough, on the bench it turned out to be a "toughie." First the tuner was tediously checked, the i.f. strip looked over, and the video amplifiers tested. Nothing. The benchman stopped and rescrutinized the symptoms. A bell rang. Not only was there sound in the picture but a varying buzz in the sound indicated that there was video in the audio. A question grew in the shop technician's mind. Where can the sound get in the picture and also the picture get in the sound? He shouted as he found it. The screen grid of the audio output 25L6 tube was fed "B+" from the damper, see Fig. 3. Acting as a filter capacitor for a connecting "B+" line that fed the video i.f.'s was a 200 µfd., 150 volt capacitor shown circled. It was open, no longer filtering. The audio and video were able to fraternize unhindered. A new capacitor restored perfect performance.

This was a good piece of bench labor but it consumed many hours. However, the set owner paid the bill without a whimper because he had been adequately briefed.

A lot of TV bench repair jobs are lost after customer permission is granted when a technician talks too much. There is a certain amount of tactful "gab" that is necessary, but all trends of conversation should be curtailed as soon as the set owner says OK. We have a gimmick for this. It might on the surface appear silly but dollars and cents wise it is very effective. As soon as the client gives permission we always ask, "Do you have a little paper bag to stow the knobs and bolts?" Once your customer is set into motion helping you to remove the chassis your sale is final.

Fig. 3. When the circled capacitor shown here became open, sound bars appeared on the CRT screen, and at the same time, a video buzz became apparent in the sound.

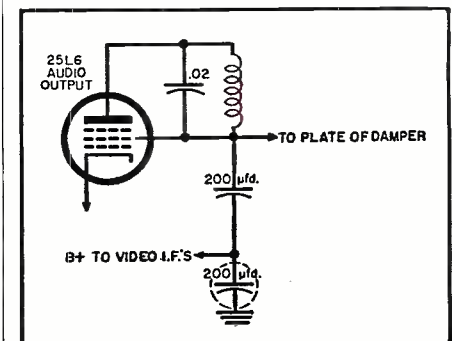

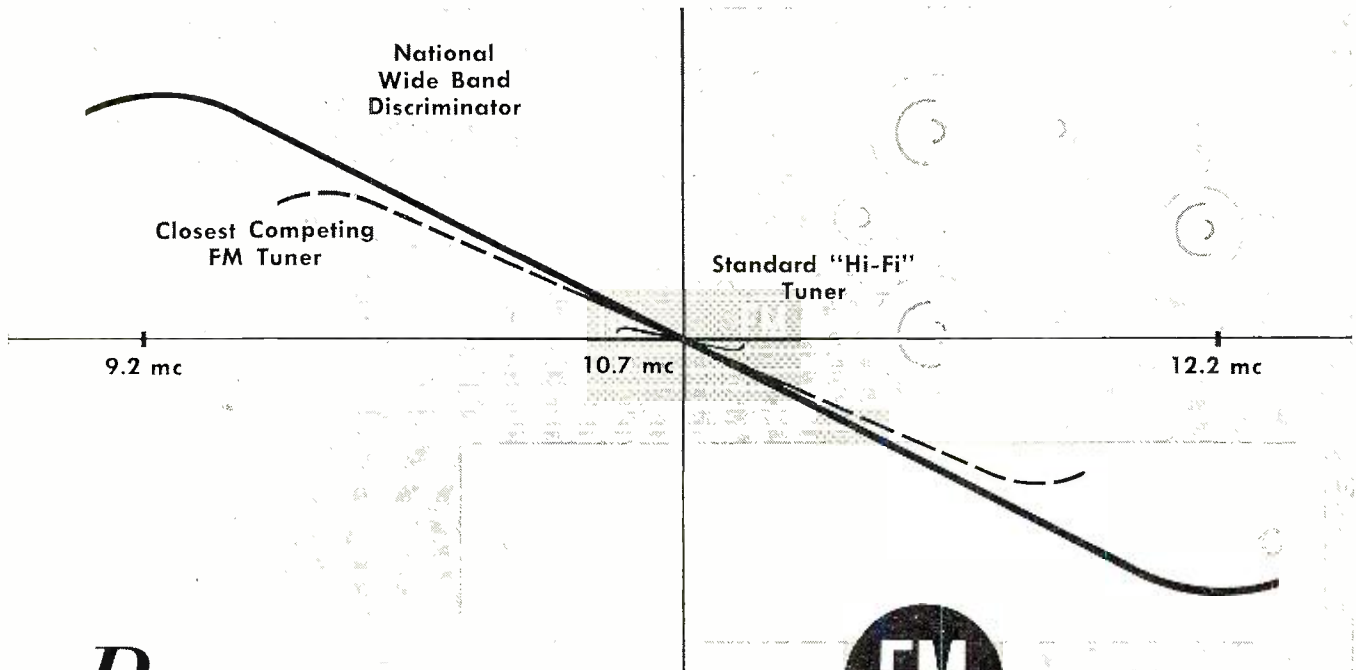

Portrait of the ultimate in **FM** listening...

The "S" curve shown above is graphic proof of the superior performance you get from the National CRITERION FM-AM Tuner on music signals originating from FM stations.

For this characteristic trace of the CRITERION's wide-band discriminator shows a bandwidth of 3 megacycles, compared to the 2 megacycle bandwidth of the closest competing FM-only tuner, and the 0.3 megacycle bandwidth of the vast majority of so-called "hi-fi" tuners!

Just what does this superior design mean to you — a discriminating listener?

Simply this. Your FM reception suffers far less interference from stations broadcasting on nearby frequencies. Overall distortion is kept to the lowest value of any tuner — below 1% from antenna to output jack. And it's this low distortion that makes the CRITERION the *true* hi-fi radio instrument.

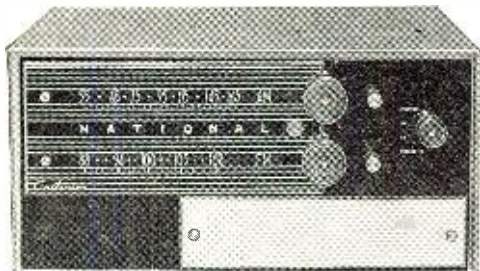

National
CRITERION
FM-AM
TUNER

The National CRITERION offers you many other extra-quality engineering advances to improve your enjoyment of FM and AM reception, too. Here are just a few.

- Exceptional FM Sensitivity — Better than 35 db of quieting on 2 microvolt input signal. Pulls in the weakest of "fringe" FM stations.
- Simultaneous AM-FM — Independent channels of unusual flexibility for reception of stereophonic broadcasts.
- Mutamatic — Special squelch circuit eliminates annoying between-stations hiss on FM. Stations snap into "focus" out of complete silence as you tune.
- High Capture Ratio — Wide band discriminator and instantaneous limiters reject interference up to 80% of the strength of the desired signal. Traffic noise and aircraft interference are eliminated.

All these features add up to the ultimate in FM listening for your home, whether you're an engineer who understands these superior features, or a music-lover who can enjoy them to the fullest.

For all the facts about the CRITERION FM-AM tuner, and other outstanding high fidelity products, write today to NATIONAL COMPANY, Dept. RT-3, 61 Sherman Street, Malden 48, Massachusetts.

National

tuned to tomorrow

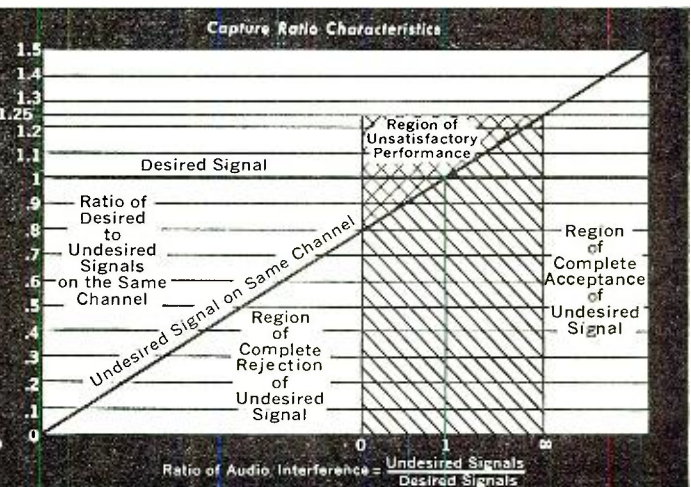
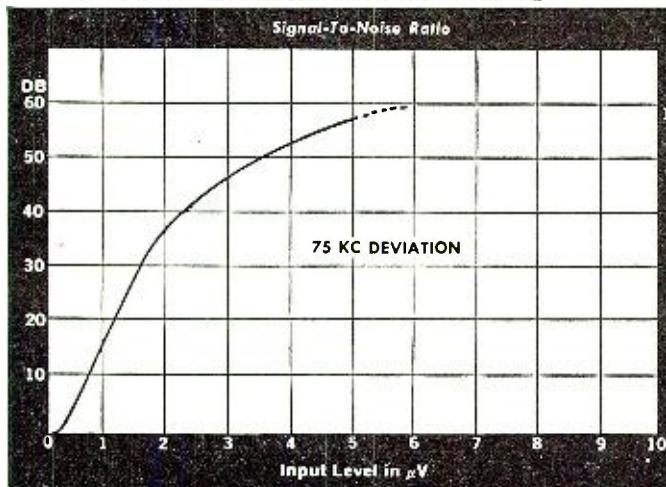

Mullard *audio* Tubes Made for Music

*crafted by masters
for audio use
exclusively!*



*the greatest
names in
high fidelity
use
Mullard
tubes*



ECC 83/12AX7
Eliminate
microphonics
only \$2.50 NET

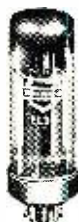

EL 34
High power
output up to
100 watts
only \$3.95 NET
MATCHED PAIRS
\$8.95 NET

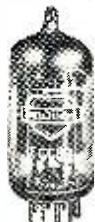

ECC 81/12AT7
only \$2.50 NET
ECC 82/12AU7
only \$2.15 NET



EL 37
Replacement for
6L6-5881-KT66
only \$3.50 NET
MATCHED PAIRS
\$7.95 NET



EL 84
Powerful
miniature
output
only \$2.40 NET



EF 86
Special
designed
Input pentode
only \$2.75 NET

Mullard DISPLAY

Booths 831-833
I. R. E. SHOW
MAR. 19th-22nd

For complete circuit and tube information write: Dept. RTN-3

Available at your local distributor or write to:

INTERNATIONAL ELECTRONICS CORP. 81 Spring Street, New York 12, N. Y.

MULLARD  **PRODUCTS**

RECEIVING AND SPECIAL PURPOSE TUBES • ULTRASONIC EQUIPMENT
RADAR • ELECTRONIC INSTRUMENTS • HIGH FIDELITY EQUIPMENT

Is This In Your Attic?

Berliner
Gramophone



ALSO WANT

Columbia Grand Graphophone
Hill Talking Machine
Improved Gramophone (Zon-o-phone)
Eagle Graphophone
Victor Models A, B, C & D
Friend Talking Machine
Columbia AY Disc Graphophone
Edison Concert Phonograph
Edison and Columbia Coin Machines

AND

Miscellaneous disc and cylinder phonographs with "outside" horns.

Write full
description to

RADIO & TELEVISION NEWS

Box 50
366 Madison Ave.
New York 17, N. Y.

What's New in Radio

REMOTE TV CONTROL

A remote unit that will control all of the important television receiver adjustments from up to 30 feet away, is currently being introduced by the *RCA Service Company, Inc.* as its "RCA Magic Brain Remote TV Control."

The control is designed to turn the set on, change stations, adjust volume, picture, and fine tuning, and turn the set off. The accessory can be installed on 163 of the company's TV models manufactured since 1951 which do not have u.h.f. tuners.

Small enough to fit in a hand, the control unit measures 2¼" in width, 2" in height, and 5½" in length. The durable, brown plastic unit contains



three separate control knobs for fine tuning, picture control, and "on-off" and volume as well as a dial for all v.h.f. channels.

The control unit is connected to the TV receiver by a 30-foot flat, protectively-covered cord. It comes complete with a subchassis and motor that are installed inside the receiver.

CLIP-IN RECTIFIER

Selenium rectifiers equipped with a new spring-steel, snap-action mount providing greater ease of assembly have been announced by *Federal Telephone and Radio Company*, 100 Kingsland Road, Clifton, New Jersey.

The new type mount now makes it possible to remove the rectifier from the radio or TV set without unbolting the chassis from the cabinet. The new mount is assembled to the rectifier's center stud or bolt as an integral part of the assembly. It is so constructed that when the rectifier is snapped into two parallel slots in the chassis, the chassis wall is gripped between two barbs and two curved counter springs of the mount. A rigidly locked, wobble-free mounting results.

The new mount can be adapted to

MONEY SAVING

TUBE VALUES!

CASH FOR YOU!

We urgently need for government contracts military electronic equipment, such as: BC312, BC342, BC348, ART13, APR4, ARC1, ARC3, ARN6, ARN7, BC221, BC788, BC610, and many others. State conditions, type and best price.

SELECT THE TUBES YOU NEED FROM ONE OF THE MOST COMPLETE TUBE INVENTORIES IN THE WORLD

TUBES! First Quality — Fully Guaranteed — Standard Brands — No Seconds TUBES!

OTHER SPECIALS

2000 OHM PER VOLT AC-DC VOM MULTITESTER
POCKET SIZE — MODEL RH-42
 22 Full Scale Ranges
 DC VOLTS: 0-6; 0-12; 0-60; 0-300; 0-1200.
 AC VOLTS: 0-6; 0-12; 0-60; 0-300; 0-1200.
 DC CURRENT RANGES: 0-300 microamps; 0-3 MA; 0-300 MA.
 RESISTANCE RANGES: 0-20K Ohms; 0-2 Megohm.
 DECIBEL RANGES: 5 ranges from -20 to +46 db.
 Complete, assembled. (Not a kit)
 Price per Each (with Test Leads) **\$12.95**

HI FI TURNOVER CARTRIDGE MODEL RH-800
 FREQ. RANGE: 40-14,000 CPS
 4 or — 2 DB.
 STYLE: 2 sapphire (1 LP and 1 Std.)
 OUTPUT: .5 volts.
 Price per Each **\$2.75**

LAPEL MICROPHONE MODEL RH-550
 WEIGHT: 1 1/2 oz. 1 3/8" dia.
 OUTPUT LEVEL: 55 db. Excellent frequency response. Chrome plated case with Handy Lapel Clip. 5 ft. shielded cable.
 Price per Each **\$2.95**

DYNAMIC EAR PHONE MODEL RH-14
 Lightweight Plastic. Fits right into ear. SENSITIVITY: 65 db. DC resistance 2000 ohms. HIGH IMPEDANCE: 5000 ohms. Complete with 3 ft. cord.
 Price per Each **\$1.95**
 LOW IMPEDANCE: (8 ohms) Model RH-15 **\$1.95**

CRYSTAL MICROPHONE High Quality MODEL RH-12
 OUTPUT LEVEL: -57 db. FREQUENCY RESPONSE: 30-10,000 cycles. CABLE: 5 ft. shielded. FITTING: Standard 3/8" 27 thread. SIZE: 1 1/2" H x 1 1/4" D. Grill Dia. 2 3/8".
 Price per Each **\$4.95**
 Lots of 3 **\$11.85**

Command Equipment (274N-ARC5, ATA)
 ALL COMPLETE WITH TUBES

Description	Excellent BRAND	NEW
Receiver 190-550 Kc.	\$11.95	\$14.95
Receiver 3-6 Mc	8.29	11.95
Receiver 6-9 Mc	9.95	14.95
Modulator	2.75	4.15
Transmitter 4-5.3 Mc	11.95	12.95
Transmitter 5.3-7 Mc	7.95	8.95
Transmitter 7-9.1 Mc	8.95	11.95
3-Receiver Control Box	1.49	1.95
Transmitter Control Box	1.25	1.49
Transmitter 3-4 Mc	14.75	19.50
Receiver 100-156 Mc	14.95	
Transmitter 100-156 Mc	22.50	
Transceiver 420-500 Mc		29.50
Beacon Recvr 195-420 Kc.	4.95	

RECEIVING TUBES

0Z4	.49	6B4G	.95	7B5	.65
1A3	.68	6B8	.67	7B6	.75
1A7GT	.52	6BA6	.63	7B7	.75
1AE4	.92	6BC5	.68	7C5	.75
1AX2	.95	6BE6	.65	7C6	.75
1B3GT	.79	6BF6	.68	7C7	.79
1C5GT	.55	6BG6G	1.75	7F7	.85
1G4GT	.65	6BH6	.79	7F8	1.10
1G6GT	.49	6BJ6	.69	7N7	.85
1H5GT	.58	6BK7	1.05	7R7	.95
1J6GT	.69	6BL7GT	1.05	7V7	.95
1L4	.74	6BN6	1.10	7Y4	.65
1L6	.79	6BQ6GT	1.15	12A6	.57
1LA4	.79	6BQ7A	1.15	12A8GT	.79
1LA6	.85	6C4	.38	12AH7GT	1.05
1LB4	.85	6C5	.48	12AT6	.48
1LC5	.79	6C5GT	.46	12AT7	.92
1LC6	.79	6C6	.49	12AUG6	.62
1L05	.85	6C8G	.85	12AU7	.75
1LE3	.79	6CB6	.68	12AV7	.95
1LH4	.85	6D6	.59	12AX7	.78
1LN5	.79	6E5	.75	12AY7	1.15
1NSGT	.59	6F5	.59	12BA6	.60
1R4	.65	6F6	.85	12BA7	.89
1R5	.65	6F6GT	.69	12BE6	.65
1S4	.65	6F7	.85	12BH7	.89
1S5	.65	6F8G	.72	12C8	.69
1T4	.65	6G6G	.72	12H6	.59
1T5GT	.69	6H6	.59	12J5GT	.65
1U4	.67	6H6GT	.49	12K7GT	.85
1U5	.59	6J5	.48	12K8	.69
1V	.65	6J5GT	.47	12SA7	.69
1V2	.59	6J6	.68	12SA7GT	.69
1V6	1.49	6J7	.82	12SC7	.75
1X2A	.85	6J7GT	.65	12SG7	.79
2A3	.95	6K6GT	.65	12SH7	.65
2A5	.65	6K7	.74	12SJ7	.69
2A6	.59	6K7GT	.59	12SK7	.65
2X2	.49	6K8	1.10	12SL7	.85
2X2A	1.35	6K8GT	.95	12SN7GT	.75
3A4	.50	6L6	1.69	12SQ7	.59
3A5	.64	6L6G	.98	12SR7	.59
3B7	.39	6L7	.95	12V6GT	.73
3D6	.39	6N7	.89	12W6GT	.87
3LF4	.85	6Q7	.85	14A7	.79
3Q4	.65	6Q7GT	.79	14B6	.65
3Q5GT	.75	6R7	.85	19B6GG	1.89
3S4	.65	6R7GT	.68	19T8	.95
3V4	.69	6S4	.57	25BQ6GT	1.25
5AW4	1.10	6S4A	.79	25L6GT	.65
5R4GY	1.45	75A7GT	.79	25W4GT	.72
5T4	.90	6S8Y7	.87	25Z5	.75
5U4G	.58	6SC7	.72	25Z6	.62
5V4G	.88	6SF5	.72	30	.65
5W4GT	.65	6SF5GT	.69	32L7GT	.85
5X4G	.75	6SG7	.65	35A5	.68
5Y3GT	.49	6SH7	.74	35B5	.68
5Z3	.69	6SJ7	.69	35L6GT	.65
5Z4	.89	6SJ7GT	.64	35W4	.44
6A3	.95	6SK7	.64	35Y4	.65
6A6	.82	6SK7GT	.59	35Z3	.65
6A7	.89	6SL7GT	.79	35Z5GT	.44
6A8	1.05	6SN7GT	.75	41	.75
6A8GT	.95	6SQ7	.59	42	.69
6A8A	.59	6SQ7GT	.59	43	.79
6A87	.95	6SR7	.75	50A5	.68
6AC7	.85	6SS7	.55	50B5	.68
6AF6G	.85	6ST7	.75	50C5	.68
6AG5	.72	6T8	.95	50L6GT	.62
6AG7	.98	6U5/6G5	.85	50Y6GT	.78
6AH6	.85	6U8	.95	53	.92
6AJ5	1.49	6V6	1.10	70L7GT	1.15
6AK5	.69	6V6GT	.59	75	.65
6AK6	.75	6W4GT	.65	77	.47
6AL5	.58	6W6GT	.79	78	.57
6AL7	.95	6X4	.48	80	.59
6AQ5	.57	6X5GT	.49	83	.59
6AQ6	.57	6Y6G	.89	83V	.95
6AT6	.52	7A4	.79	84/6Z4	.49
6AU5GT	1.10	7A5	.69	117L/M7GT	1.65
6AU6	.65	7A6	.78	117N/P7GT	1.45
6AV6	.53	7A7	.75	117Z3	.68
6AX4GT	.79	7A8	.75	117Z6GT	.95
6AX5GT	.69	7AG7	.95		

TRANSMITTING AND SPECIAL PURPOSE TUBES

0A3/VR90	.86	250TH	18.95	959	1.32
0B3/VR90	.73	250TL	14.75	991	.29
0C3/VR105	.68	274A	1.40	1603	2.95
003/VR150	.68	274B	.85	1616	.50
1B22	1.25	204TH	7.95	1619	.30
1B23	2.68	304TL	9.95	1622	1.45
1B24	4.85	307A	1.10	1624	.29
1B27	12.95	350A	2.65	1625	.95
1B35	3.45	350B	2.35	1626	.19
1B38	33.50	371B	.85	1633	.85
1N21	.39	393A	4.50	1635	1.48
1N21B	1.45	417A	2.95	1641	1.35
1N23	.68	434A	2.95	1654	1.75
1N23B	1.40	450TH	47.50	2050	.93
1N34	.42	450TL	35.00	2051	.65
1N34A	.48	575A	9.95	5516	6.90
2AP1	4.95	705A	.68	5517	1.65
2C39A	12.45	707B	4.25	5637	4.95
2C40	7.45	714AY	35.00	5638	7.95
2C43	7.25	715C	10.95	5639	8.95
2V51	2.95	717A	.35	5642	.95
2D21	.65	721A	.65	5651	1.35
2E22	3.45	726A	6.95	5654	1.25
2E24	1.95	725A	2.95	5670	1.45
2E26	2.95	723A/B	8.45	5675	10.95
2E30	1.95	726B	32.50	5676	1.45
2J32	12.50	726C	32.50	5686	2.45
2J36	14.95	750TL	39.50	5687	2.65
2J51	97.50	801A	.38	5703	.95
2J55	39.50	802	2.45	5763	.95
2J61	12.95	803	1.40	5794	7.50
2J62	4.45	804	8.85	5814	.98
2K25	11.95	805	3.95	5819	34.50
2K28	27.50	806	4.85	5823	1.35
2K33A	56.90	807	1.18	5851	3.45
3AP1	2.90	808	1.25	5876	12.50
3B24	.95	809	2.20	5879	1.25
3BP1	2.45	810	9.50	5881	2.95
3C22	59.50	811	2.75	5886	2.75
3C23	3.45	812	2.45	6146	4.75
3C24	1.48	813	10.50	8005	4.75
3C45	5.95	814	1.50	8008	3.95
3D21A	3.95	815	1.50	8012	.98
3OP1	3.45	816	1.15	8013	2.65
3E29	8.43	826	.65	8014	67.50
4-125A	18.95	828	7.42	8020	1.45
4-250A	29.50	829B	7.95	8025	1.45
4C27	3.25	830B	.65	9001	.82
4C28	17.45	832	5.75	9002	.60
4C35	13.45	832A	7.95	9003	.90
4E27	7.95	833A	37.50	9004	.35
4X150A	22.45	836	1.45	9005	1.39
5BP1	2.35	837	.88	9006	.25
5BP4	1.95	838	.69	C1JA	10.95
5C22	27.50	845	4.85	C6J	6.45
5CP1	1.95	851	8.95	CK1005	.32
5CP7	7.95	860	2.75	CK1006	3.45
5D21	4.95	861	12.95	CK1007	.65
5FP7	1.37	866A	.98	F-123A	2.75
5JP1	12.45	869B	14.95	F-127A	22.50
5JP2	6.35	872A	1.25	F-128A	14.95
5LP1	7.40	876	.72	FG-17	2.90
5NP1	2.95	878	.48	FG-27	12.95
6AN5	4.75	884	.95	FG-32	3.95
6AS6	1.19	885	.95	FG-95	17.50
6AS7G	2.35	902A	2.95	FG-105	12.95
6C21	14.95	918	1.65	FG-172	17.95
6J4	2.55	823	1.25	HF-100	6.95
7BP7	4.95	927	.95	HF-200	9.95
12DP7	17.50	930	1.19	HF-300	17.50
15E	1.05	931A	2.45	WL-616	47.50
28D7	.75	954	.25	MX408U	.50
100TH	6.25	955	.35	RK-65	7.50
211	.45	956	.35	RK-72	.50
212E	14.95	957	.35	RX-21	5.50
249C	1.95	958	.35	TZ-40	3.50

WRITE FOR OUR FREE FLYER

TERMS: Cash with order or 25% deposit—balance C.O.D. Not 10 days to rated accts. All prices net F.O.B. our warehouse.

Special Quantity Discounts

All Inquiries Answered Promptly

WE SHIP TO ALL THE WORLD. CORRESPONDENCE IN ALL LANGUAGES. CABLE ADDRESS: HAMSHACK NEW YORK

RADIO HAM SHACK, Inc.

370 Greenwich Street, New York 13, N. Y. Telephone CAnal 6-8446



rectifiers rated from 25 to 195 volts a.c. and from 65 to 750 milliamperes d.c. Requests for further information should be addressed to the Components Division of the company.

TUBULAR PI FILTERS

Cornell-Dubilier Electric Corporation of South Plainfield, N. J. is now offering a new series of "Quietone" pi filters in tubular cases.

These metal-cased, hermetically-sealed tubular type filters, in the handy, threaded-neck mounting style, offer high insertion loss values for the suppression of radio noise. They are made to the smallest possible sizes and minimum weight for the stated ratings and attenuation characteristics.

Currently available are units in the range of .1 to 50 ampere at voltages of 28, 50, 100, 300, and 500 d.c. and 115 and 125 a.c. Frequencies are 60, 400, and 1000 cps.

For further information and catalogues make your request on company letterhead.

PANORAMIC RECEIVER

CGS Laboratories, 391 Ludlow Street, Stamford, Conn. has recently introduced a precision, all-electronic panoramic receiver designed especially for v.h.f. applications.

Covering the range from 100 to 150 mc., this "Trak" receiver features three controllable inductor-tuned r.f. stages in a double superheterodyne cir-

cuit which provides more than 60 db attenuation of all spurious responses and a noise figure no greater than 13 db throughout the tuning range.

Seven tracked "Increductor" controllable inductor tuned circuits operate without moving parts to provide vibration-free operation and virtually unlimited life. A precision marker circuit permits frequency measurements

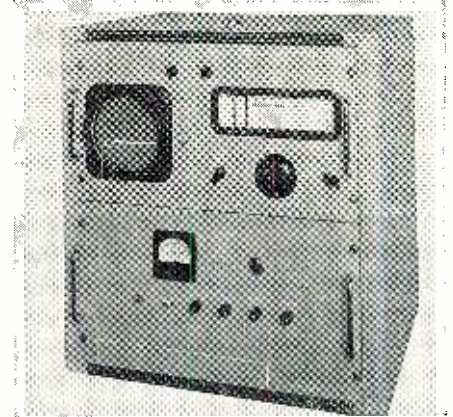

on observed signals to an accuracy of better than 1 per-cent.

Illustrated literature giving details of circuitry, performance, and tube complement on the Model PAN-1 is available from the company on request.

THE **ONE** SPEAKER FOR ALL LOW-LEVEL P. A. INSTALLATIONS

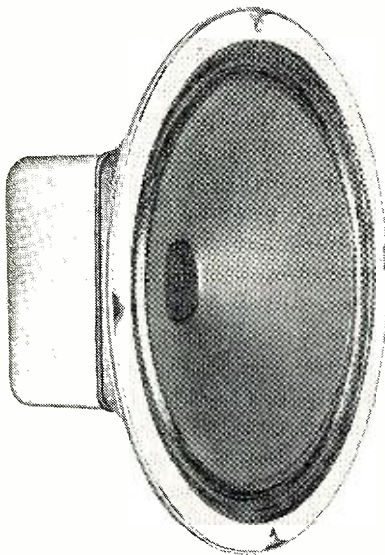

By Altec Lansing—
A Famous Name
in Sound!

Altec Lansing 401A

Power Capacity— 14 watts
Impedance— 8 ohms
Resonance— 75 cps
Voice Coil
Diameter— 1"
Depth— 3-5/8"
Frequency
Response— 60 to
10,000 cycles

In public address or paging systems requiring a number of speakers to be operated at low levels, the Altec Lansing 401A is your best choice. Offering the highest quality available in inexpensive 8" loudspeakers, the 401A has a frequency response of 60 to 10,000 cycles—well beyond the ordinary performance of public address speakers.

The low price of Altec's 401A also allows you to install more speakers for the same investment. At only \$13.20, the Altec Lansing 401A is your best buy—and your best choice—for high quality, low-level performance in any public address or paging system.



Dept. 3-T
9356 Santa Monica Blvd., Beverly Hills, Calif.
161 Sixth Avenue, New York 13, N.Y.

LOUDSPEAKERS • AMPLIFIERS • PREAMPLIFIERS • TUNERS • ENCLOSURES

TRANSISTOR KIT

General Transistor Corp. of Jamaica, New York is now offering a kit of six diffused p-n-p junction transistors for all types of radio receivers.

Designed for experimenters, engineers, and technicians, the kit includes one converter-oscillator unit, two i.f. transistors, and three audio transistors, all packed in a functional lucite box. Users of the kit will find they can build almost any type radio with this assortment.

For full details on Kit No. 2, write the company direct.

"Q" MULTIPLIER KIT

Of interest to radio amateurs is the new "Q" multiplier kit recently released by Heath Company of Benton Harbor, Michigan.

Especially effective on the phone and c.w. bands when the QRM is heavy,

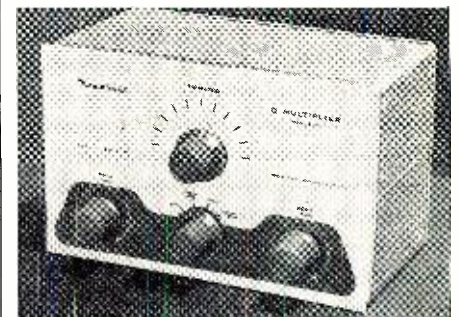

the new QF-1 provides an effective "Q" of approximately 4000 for extremely sharp "peak" or "null." It can be used to peak the desired signal or null an undesired signal or heterodyne. It will tune any signal within the i.f. bandpass of the receiver. It also provides "broad peak" for conditions

where extreme selectivity is not required.

The multiplier operates with any receiver having an i.f. between 450 and 460 kc. It cannot be used with a.c.-d.c. type receivers. As is customary with *Heathkits*, this unit comes complete with full instructions for assembling the device.

TRANSISTOR RECEIVER

Raytheon Manufacturing Company's Television and Radio Division, Chicago, has recently introduced the new "Deluxe T-150" portable pocket receiver as the fourth unit in its line of transistorized radios.

The T-150 uses six transistors to provide seven-transistor performance. It is said to have five times the power and volume of vacuum-tube type pocket-sized receivers. A compact 9-volt battery powers the receiver. It will play for more than 150 hours in normal use or about four months of normal listening time on this battery.

The receiver is housed in a compact thermoplastic resin case, in five differ-



ent color combinations. It measures 1 3/4" thick, 6 1/8" long, and 3 1/4" tall. It weighs only 22 ounces with battery. The receivers come equipped with a gold-finish, flexible carrying strap which permits them to be carried over the wrist.

NEW BOX CHASSIS

LMB of 1011 Venice Boulevard, Los Angeles 15, California has announced the addition of thirty-three new sizes and shapes to its line of "Flangelock" box chassis.

This type of construction is designed to provide 100 per-cent shielding. It is also dustproof and moistureproof and can be made rainproof for outdoor installations by sealing.

A catalogue listing all of the sizes in this new series is available from the manufacturer on request.

HUGHES TRANSISTORS

The Semiconductor Division of *Hughes Aircraft Company*, Culver City, California has announced the availability of three new *n-p-n* fused junction germanium transistors, Types HA5001, HA5002, and HA5003.

All of the new units are medium power transistors characterized by high gain and low noise figures. In ad-



G-E "GOLDEN TREASURE" CARTRIDGE with new Clip-In-Tip Diamond Stylus brings you front row fidelity—at home

EVERY NOTE of music from the sonorous bass viol to the tinkle of the triangle is reproduced with stunning clarity by the "Golden Treasure" Cartridge. Long-lasting G-E diamond styli* reduce wear on record grooves to make records last longer, sound better. General Electric is the choice of audio experts, professional broadcasters, home music lovers everywhere.

Only General Electric has the exclusive Clip-In-Tip design that makes stylus re-

placement so easy. With Clip-In-Tip, anyone can replace a G-E stylus instantly. Now it's easy to use good styli all the time—and protect your records, too.

When buying a new cartridge, or replacing a worn-out stylus—be sure you insist on the genuine G-E. See your hi-fi dealer for a demonstration. *General Electric Co., Special Products, TV Dept., Section R1536, Electronics Park, Syracuse, New York.*

**G-E sapphires available at lower cost.*

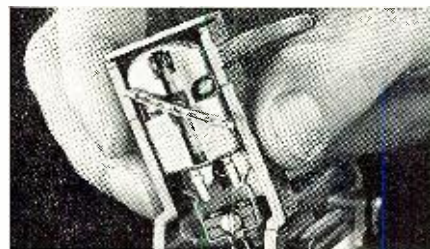

IT'S EASY! Raise the tone arm to permit free rotation of the Clip-In-Tip stylus. . .

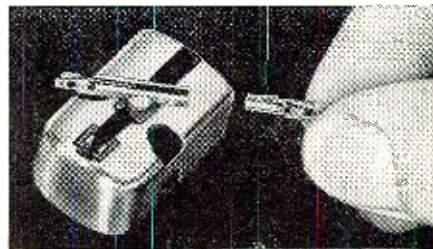

IT'S QUICK! Worn stylus slides out—new stylus clips in. That's all you have to do!

Progress Is Our Most Important Product

GENERAL  ELECTRIC

Problem:

**2 TV Sets
1 Antenna**

Answer:



2-SET COUPLER

Model TV-42
Approved for Color TV
UHF, VHF and FM



Cost: ONLY \$2⁹⁵ LIST

Features:

- Matched resistive circuit
- Flat response — 0 to 900 megacycles
- 12db inter-set isolation
- Easy to install
- Couples 2 TV sets without ghost or smear

Application:

In class A signal areas the B-T 2-Set Coupler provides the ideal low cost solution to the problem of operating two receivers from one antenna. There are other applications. For example, the TV-42 can couple a TV set and FM receiver to one antenna—or it can be used, in reverse, to couple or mix 2 antennas to one receiver.

Write for FREE BOOKLET — "TV for 2 or 3... or More"
Covers all types of Multiple TV Systems

Sold by Radio-TV Parts Distributors and Jobbers
BLONDER-TONGUE LABORATORIES, INC.
Dept. LC-4 Westfield, New Jersey



Manufacturers of TV Cameras,
TV Amplifiers, Boosters,
UHF Converters, TV Accessories
and Originators of the Masterline
and 'Add-A-Unit' Master TV Systems.

dition, they exhibit a negligible *alpha* crowding effect at high currents. The low *alpha* crowding effect makes these new units particularly applicable to high-current, medium-power amplifiers. They are also suitable for computers, switching, audio amplifiers, i.f. amplifiers, r.f. amplifiers, and oscillator applications.

Write the manufacturer direct for full specifications on these transistors.

SUBMINIATURE WIREWOUNDS

Reon Resistor Corp. of Yonkers, New York is currently offering a new line of miniature and subminiature wirewound resistors designed especially for printed circuit and crowded chassis applications.

The new "M" series miniature units have an o.d. of $\frac{3}{8}$ " while the subminia-



ture "SM" series are $\frac{1}{4}$ " o.d. An optional pigtail construction features "R"-radial, "A"-off center axial, or "C"-central axial. Resistors are available in open bobbin style with the company's "Plastikote" impregnation or hermetically sealed by epoxy encapsulation. The latter coating exceeds the salt atmosphere characteristic "A" of the new amendments to MIL-R-93A.

Available wattages are from .1 to 2.5 watts and ohmic values up to 2.5 megohms. Write the company for full details.

FOUR-VOLT BATTERY

The Tube Division of *Radio Corporation of America*, Harrison, N. J. has developed a new 4-volt mercury battery which is especially designed for battery-operated radio receivers using circuits with both tubes and transistors.

The new Type VS400 is $1\frac{1}{32}$ " in diameter and $1\frac{31}{32}$ " high and has flashlight-type terminals. It is the third battery the company has released recently for transistor operation. The earlier units were the VS300 and the VS301, both 9-volt batteries.

NEW TWIN TRIODE

The Tube Department of *General Electric Company*, Schenectady 5, New York has added the 6CG7 to its line of 600 ma. controlled-warm-up tubes.

This 9-pin twin triode miniature equivalent of the 6SN7GTB is designed for use in a variety of circuit applications, particularly as vertical and horizontal oscillators in television receivers. It may also be used as a blocking oscillator, phase inverter, multivibrator, or in any application requiring a medium mu twin triode.

The 6CG7 has a controlled heater warm-up characteristic of 11 seconds

ATTENTION

- **Electronics Classes**
- **Study & Employee Groups**
- **Service Technician Organizations**
- **Club Members**

Subscriptions to **RADIO & TELEVISION NEWS** — the world's leading electronics magazine — are available at special bulk rates for schools, study and employee groups, clubs, etc.

For information, write to:

RADIO & TELEVISION NEWS

Dept. 1016
366 Madison Ave.
New York 17, N. Y.

RADIO & TELEVISION NEWS

which makes it suitable for TV sets using either parallel-connected heaters or in sets which employ 600 ma. series-connected heaters.

INDUSTRIAL TV CONTROLS

The Electronics Department of *Diamond Power Specialty Corporation*, Lancaster, Ohio has designed a new remote control pan and tilt mount especially for use with its "UtiliVue" and other industrial TV cameras.

Rotation is full 360 degrees and it can be limited to any arc desired. Tilt



is 45 degrees above horizontal and 45 below—90 degrees in all. Complete 360 degree rotation is accomplished in 36 seconds while the 90 degree tilt requires 15 seconds. Pan and tilt motions are driven by separate motors individually and remotely controlled from a control panel located at any desired point. The mount is especially useful where it is necessary to have one camera cover a very wide area. The unit may be used in both indoor and outdoor installations.

CBS TRANSISTOR RADIO

CBS-Columbia, 3400 47th Avenue, Long Island City 1, New York has just released its first all-transistor receiver which is designed to be played anywhere in the house without the necessity for plug-in cords or electrical outlets.

The cordless receiver operates on six transistors and a self-contained battery pack. The battery will provide up



to 1500 hours of normal radio listening before replacement is required. The receiver is a full-sized home table set which includes a 9" oval speaker with the sound emanating from both the

March, 1956

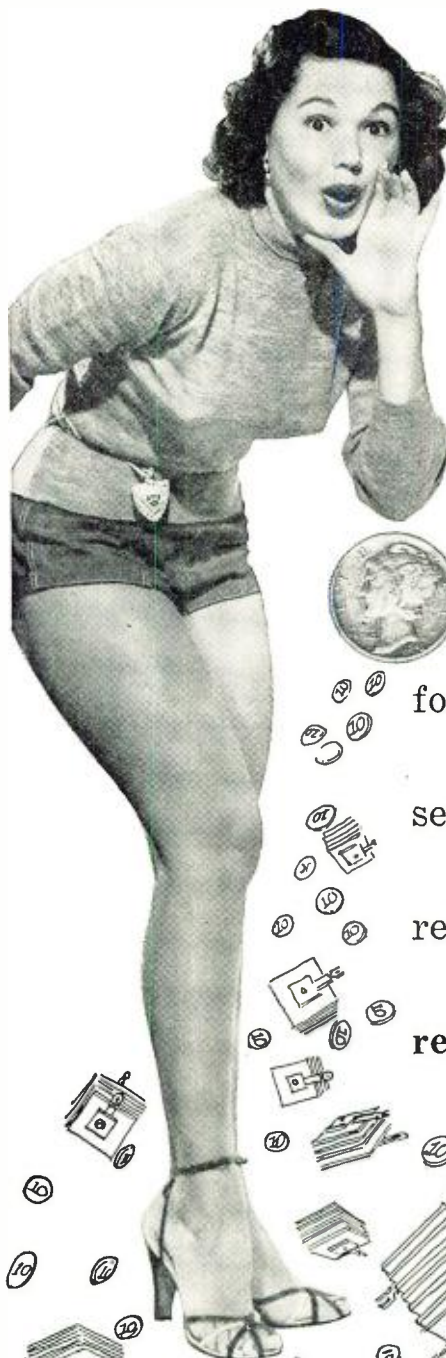

HAVE YOU

HEARD that

our distributors

will allow you

10c credit

for each replaced

selenium rectifier

returned —

regardless of make?

The selenium situation is critical, and reclamation is necessary to meet civilian, as well as military requirements. You can help by returning every replaced selenium rectifier to your distributor for credit.

Sarkes Tarzian, Inc., RECTIFIER DIVISION 415 N. COLLEGE AVE. BLOOMINGTON, INDIANA

In Canada: 700 Weston Rd., Toronto 9, Tel. Murray 7535

Export: Ad Auriema, Inc., New York City

don't do it
the hard way!

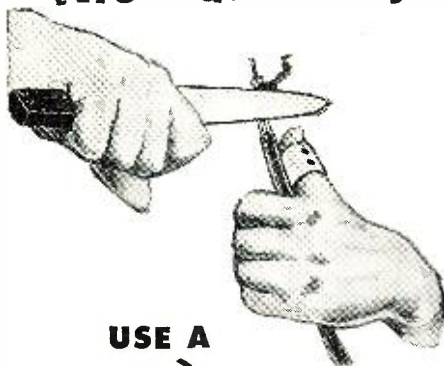

USE A



ROTARY CABLE STRIPPER

Model S-1



As Easy
as Sharpening
a Pencil

FAST
ACCURATE • CLEAN

and Practically **AUTOMATIC**

- Cuts and strips the outer covering of coax cable without injuring the shielding.
- Cuts the shielding without pulling, fraying or unbraiding.
- Cuts and strips the inner insulation and . . .
- ➔ Measures just the right length of lead desired.
- ➔ Ideal for stripping all insulated wire and cable — as well as non-metallic tubing.

— and its **ONLY \$3⁷⁵** LIST

A Must For Your Kit —
Get One Today
at your Parts Distributor.

BLONDER-TONGUE LABORATORIES, INC.
Dept. JC-4 Westfield, New Jersey



Manufacturers of TV Cameras,
TV Amplifiers, Boosters,
UHF Converters, TV Accessories
and Originators of the Masterline
and 'Add-A-Unit'
Master TV Systems.

front and rear of the cabinet through the company's special "soundwave" grille cloth. A slide rule dial makes it possible to tune the receiver from either side or from the top.

When the receiver is placed on its auxiliary metal stand, the radio is transformed into a chairside unit. Lifted out of its stand, it converts into a portable. This new radio is available in a variety of color combinations and in two cabinet styles.

SUN BATTERY CELLS

A new series of selenium sun battery cells is now available from *International Rectifier Corporation*, 1521 E. Grand Avenue, El Segundo, California.

The cells, which are suitable for transistor power supply applications,

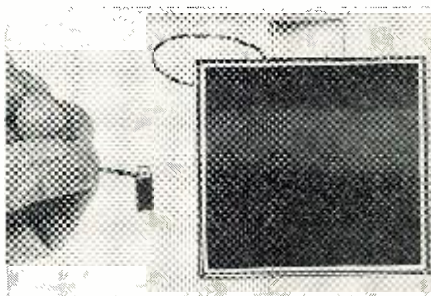

control usage, photometric equipment applications, as well as in experimental circuitry, are available in a wide range of sizes and power ratings from .14 square inch to 10.5 square inches in photosensitive area and from .1 milliwatt to 15 milliwatts power output in direct sunlight.

For full information and specifica-

tions write the company's Product Information Department and request a copy of Bulletin SR-115.

TWO-SECTION VARIABLE

Lafayette Radio, 100 Sixth Avenue, New York 13, N. Y. is now offering a new subminiature two-section variable capacitor which measures only 1" x 1" x 5/8" and is said to be the smallest unit of its type currently available.

Designed for use in miniature superhet circuits, the r.f. section capacity varies from 9 to 290 μmfd . while the oscillator section is from 7 to 129 μmfd . The capacity curve is $\pm 2\%$ with a "Q" above 6000 in the broadcast band.

The entire unit is sealed in a high-impact plastic case. It comes complete with two subminiature padders only 3/8" square.

TRANSISTOR TEST SET

Baird Associates, Inc., 33 University Road, Cambridge 38, Mass., has developed a new transistor test set, the Model GP.

It provides dependable, rapid, accurate measurement of transistor characteristics at any frequency from 100 cps to 1 mc. It is especially designed for transistor laboratory work.

The set permits measurement of *n-p-n* and *p-n-p* junction, surface-barrier, and point-contact transistors in both grounded-base and grounded-emitter circuits. Measurements of hybrid coefficients, T-network coefficients, collector saturation current, collector capacitance, *alpha* and *beta* cut-off, voltage feedback ratio, open circuit resistances, and channel effect voltage can be made.

PHONO EXTENSION CORD

By ARTHUR TRAUFFER

THIS shielded phono extension cord is easy to make and will come in handy for hi-fi hobbyists, experimenters, and service technicians. It consists of a length of shielded phono cord with a standard phono plug soldered onto one end, and a standard phono jack inside of a small metal can on the opposite end.

Any small metal can, at least 15/16" in diameter, having a friction lid is OK. The writer uses "Herb-Ox" bouillon cube cans. As shown in Fig. 1, cut off a 3/4"-long bottom section using a thin-blade, fine-tooth hacksaw, and then file the sawed edge smooth. Drill a 1/4" diameter hole in the center of the bottom and insert a small rubber grommet for the cord to pass through.

Now drill the necessary three holes in

the lid and install the phono jack in the usual manner. The center conductor in the cord is soldered to the center electrode in the jack, and the shield conductor of the cord is soldered to the outside electrode lug in the jack, as shown.

Now solder a standard phono plug on the free end of the cord in the usual manner, and test the entire assembly. If all is OK, put the lid on the can, scrape off a little of the enamel at the required places and solder the lid to the can at one or two places.

As shown in Fig. 2, the writer simply wrapped a 3/4" wide strip of "Mystik Tape" around the can to improve its appearance. Otherwise, the can could have been given a coat of enamel to cover the lettering.

Fig. 1. Break-away view of the shielded can which goes on one end of phono cord.



Fig. 2. Completed construction with the phono plug installed on the end of cord.

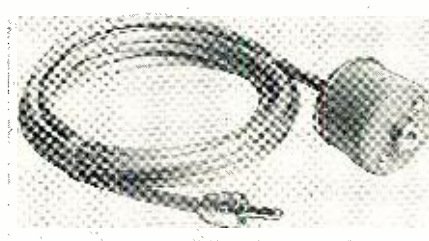

WITHOUT test instruments, the service technician would be lost. These instruments indicate a circuit or part defect in a fraction of the time that would be required if merely circuit operation analysis and parts substitution were relied on. Yet, how many of us use our test instruments to their full capabilities? And, even more important, do we always use our test instruments correctly? This column will explain how to use the various functions of the common test instruments correctly in both their well-known as well as lesser-known applications.

Ohmmeter Measurements

Almost all v.t.v.m.'s and multimeters include ohmmeter circuits for the measurement of resistance and, in general, these circuits are used in the same way. Ohmmeters are most commonly used to measure the resistance of a part or a portion of a circuit, as continuity testers, and to check capacitors for leakage. However, there are some other applications, not so well known, which will aid the service technician to cut down on servicing time and help him in tight spots. Among these uses are: the testing of crystal rectifiers and transistors, checking loudspeakers and measuring the impedance of their voice coils, and testing meter movements.

Crystal rectifier testing: A germanium diode may be tested by comparing its forward to its back resistance.

Using Your Test Equipment

By MEL BYRON

Vice-President for Engineering
Precise Development Corporation

Are you getting the most from your ohmmeter? Here are some hints on using it correctly and for more purposes.

A properly operating diode will show less resistance in the forward direction than in the reverse direction. The ratio of reverse resistance to forward resistance should be at least 500 to 1.

When using the ohmmeter to test a crystal diode, connect the positive lead of the ohmmeter to that lead of the crystal marked with an arrow. The negative lead goes to the line or bar on the crystal. In this position the ohmmeter leads are connected in the direction of minimum crystal resistance (forward). If the leads are reversed, the backward crystal resistance is measured.

An important precaution to be observed is that while a v.t.v.m. uses low voltages (about 1½ volts) in its ohmmeter section, a multimeter may use batteries giving up to 45 volts in its high resistance ranges. The multimeter does not have the advantage of a current amplifier such as that employed in the v.t.v.m. If the upper re-

sistance ranges of a multimeter were used to check diodes, there is a strong possibility of rupturing the diode due to excessive voltage. Unless otherwise stated by the manufacturer, low voltages in the neighborhood of a few volts should be used for diode testing.

The test procedure for selenium, copper oxide, manganese, or other metallic types of rectifiers is very much the same as that described for the germanium diode. This check, however, is only a partial one since many factors such as frequencies, voltages, and general operating conditions should also be tested for in a thorough check.

Transistors: A conventional transistor may be thought of as two crystal diodes connected together back to back. To test a *p-n-p* transistor, therefore, the base is treated as a common cathode while both the emitter and collector are thought of as positive connection points. With the negative

Just Out

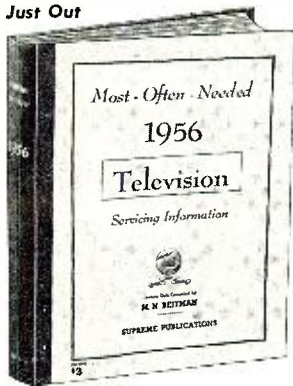

Includes all popular 1956 Sets

New SUPREME 1956 TV Manual

AMAZING BARGAIN

The new 1956 TV manual is the scoop of the year. Covers all important sets of every make in one giant volume. Your price for this mammoth manual is only \$3. This super-value defies all competition. Other annual volumes at only \$3 and \$2 each. Includes all data needed for quicker TV servicing. Factory service material simplifies repairs. Practically tells you how to find each fault and make the repair. More pages, more diagrams, more information per dollar of cost. Get the best for less. Get SUPREME.

COVERS ALL POPULAR SETS

Here is your service data for faster, easier TV repairs. Lowest priced. Best by comparison. **Supreme TV** manuals have all needed service material on every popular TV set. Helpful, practical, factory-prepared data that will really make TV servicing and adjustment easy for you. Benefit and save with these amazing values in service manuals. Only \$3 per mammoth volume. The choice of wise servicemen.

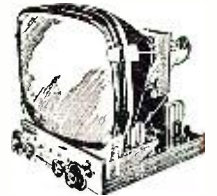

The repair of any television set is really simple with **Supreme TV** service manuals. Every set is covered in a practical manner that will simplify troubleshooting and repair. This is the help you need to find toughest faults in a jiffy. Each \$3 TV volume covers a whole year of service material. New **Television Servicing Course** will aid you in learning TV. Be wise, buy **Supreme Manuals** only once each year instead of spending dollars every week for data not needed.

TELEVISION SERVICING COURSE

Let this new course help you in TV servicing. Amazing bargain, complete, only \$3, full price for all lessons. Giant in size, mammoth in scope, topics just like a \$200.00 correspondence course. Lessons on picture faults, circuits, adjustments, short-cuts, UHF, alignment facts, hints, antenna problems, trouble-shooting, test equipment, picture analysis. Special, only **\$3**



Newest



RADIO DIAGRAMS

Here is your complete source of all needed RADIO diagrams and service data. Covers everything from the most recent 1955 radios to pre-war old-timers; home radios, auto sets, combinations, changers, FM, and portables. Sensational values. Only \$2 for most volumes. Every manual has extra large schematics, all needed alignment facts, parts lists, voltage values, trimmers, dial stringing, and helpful hints. Volumes are large in size, 8½x11 inches, about 190 pages. See coupon at right for a complete list of these radio manuals.→

SIMPLIFIES TV REPAIRS

These giant TV manuals have complete circuits, alignment facts, response curves, service hints, production changes, voltage charts, waveforms, and many double-page schematics. Here are your authentic service instructions to help you do expert work quicker; and priced at only \$3 and \$2 per large manual. Repair **any TV model** ever made by having in your shop all 11 volumes as listed in coupon. Your special price for all, only \$32. Or try the new 1956 TV manual to see what an amazing bargain you get for \$3. Send no-risk trial coupon today.

NO-RISK TRIAL ORDER COUPON

SUPREME PUBLICATIONS, 1760 Balsam, Highland Park, ILL.

Radio Servicing Manuals

Most-Often-Needed Series (See full description at left)

New 1955 Radio Manual, \$2

1954

1953

1952

1951

1950

1949

1948

1947

1946

1942

1941

1940

1939

1926-1938 Manual, \$2.50

Radio and TV Master Index, 25¢

These annual RADIO volumes specially priced at only **\$2.50** each...

THIS GROUP ONLY \$2 EACH

Rush today TV manuals checked below and Radio manuals at left. Satisfaction guaranteed.

New 1956 Television Servicing Manual, only... \$3.

Additional 1955 TV, \$3. Early 1955 TV, \$3.

1954 TV Manual, \$3. 1953 TV Manual, \$3.

1952 Television Manual, \$3. 1951 TV, \$3.

1950 Television Manual, \$3. 1949 TV, \$3.

1948 TV, \$3. 1947 TV & FM, only \$2.

New Television Servicing Course, complete... \$3.

I am enclosing \$..... Send postpaid.

Send C.O.D. I am enclosing \$..... deposit.

Name:

Address:

Supreme Publications
Sold by All Leading Parts Jobbers

HI-LITE TV TUBES

Thousands of Satisfied Customers

- all tubes branded Hi-Lite and dated
- fully guaranteed for 1 year
- individually boxed in attractive red and black cartons
- all Hickok mu tested to insure satisfaction

OZ4	.43	SU8	.78	6BA7	.64	6L6	.64	7F8	.79	12V6	.45
1AX2	.64	5V4	.64	6BD6	.45	654	.43	7H7	.59	12X4	.38
1B3	.64	5V6	.50	6BD5	.64	6Q7	.43	7J7	.79	12XA7	.43
1LA6	.64	5X8	.75	6BE6	.43	658	.43	7K7	.69	12SG7	.52
1LB4	.64	5Y3	.43	6BF5	.43	6SA7	.43	7N7	.43	12S7	.43
1LC5	.64	6AB4	.64	6BF6	.43	6SL7	.64	7Q7	.64	12SK7	.43
1LC6	.64	6AC7	.64	6BG6	.99	65N7	.43	757	.79	12SL7	.64
1LE3	.64	6AG7	.64	6BH6	.52	65Q7	.43	7Y4	.69	12SN7	.43
1LG5	.64	6AG5	.43	6BK5	.75	65R7	.64	12A4	.60	12SQ7	.43
1LH4	.64	6AF4	.75	6BK7	.75	6T8	.64	12A05	.52	12SR7	.64
1LN5	.64	6AK5	.64	6BL7	.75	6T4	.99	12AL5	.43	19AU4	.75
1N5	.64	6AL5	.43	6BQ6	.75	6U4	.64	12AT6	.43	19BG6G	.98
1Q5	.64	6AN4	.95	6BN6	.75	6U8	.64	12AT7	.64	19T8	.75
1R5	.64	6AN8	.78	6BQ7	.75	6V3	.64	12AU6	.43	25BQ6	.75
1S4	.64	6AM8	.75	6BY5	.75	6V6	.43	12AU7	.64	25AV5	.83
1S5	.43	6AQ5	.43	6BZ7	.75	6W4	.43	12AV6	.43	25CP6G	1.44
1T4	.43	6AQ6	.43	6C4	.43	6W6	.64	12AV7	.64	25L6	.43
1U4	.43	6A07	.70	6C5	.43	6X4	.43	12AX4	.64	25W4	.43
1U5	.43	6AR5	.43	6C6	.58	6X5	.43	12AX7	.64	25Z5	.43
1X2	.64	6AS5	.43	6CB6	.43	6X8	.64	12BA6	.43	25Z6	.43
2AF4	.96	6AT6	.43	6CD6	.96	6Y6	.64	12B4	.60	35A5	.43
3A3	.80	6AU6	.43	6CU6	.85	7A5	.59	12BA7	.60	35B5	.43
3AL5	.43	6AU5	.64	6CF6	.75	7A6	.69	12BE6	.43	35C5	.49
3AU6	.43	6AX7	.64	6CS5	.51	7A7	.69	12BF6	.43	35L6	.43
3CB6	.52	6AV5	.64	6F5	.43	7A8	.68	12AZ7	.64	35W4	.43
3BN6	.74	6AV6	.43	6F6	.43	7AG7	.69	12BD6	.45	35Y4	.43
3CS6	.52	6AX4	.64	6H6	.43	7B7	.49	12BH7	.64	35Z5	.43
3Q4	.55	6AX5	.64	6J5	.43	7C5	.43	12BQ6	.99	50A5	.43
3Q5	.43	6AH4	.64	6J6	.64	7C6	.43	12BZ7	.64	50B5	.44
3S4	.43	6AX7	.64	6K6	.43	7E7	.59	12B77	.64	50C5	.44
3V4	.43	6BA6	.43	6K7	.43	7F7	.64	12L6	.51	50L6	.44
4BQ7	.90									50X6	.49
4BZ7	.96									50Y7	.43
SAM8	.75									70L7	.98
5AN8	.78									80	.43
5AQ5	.52									117L7	1.10
5AT8	.75									117Z3	.43
5J6	.64									117Z6	.75
5T4	.79									807	1.39
SU4	.43									866A	1.39

SPECIALS—This Month Only

65N7GT	.32	Indoor antenna with dial selector, individually boxed.	Child's TV Chair	6.17
50L6GT	.32		Black wrought iron legs, seat & back beautifully covered. Back folds over, making a tray.	
Pix tube brightener	.82 ea.			
		OUR PRICE 3.59		

TERMS: Shipments F.O.B. Irvington, N. J. Please send full amount and allow for postage. We refund excess money. 25% deposit required on C.O.D.'s. 75c service charge on orders under \$5. Subject to prior sale.

HI-LITE
ELECTRONIC SALES CO
837A 18th Avenue • Irvington 11, N. J.

See What's New in
ELECTRONICS
Radio • TV • High Fidelity



FREE!

Send for
NEWARK'S 1956 CATALOG

See the latest and finest equipment ever offered in High-Fidelity, Radio, TV, Amateur and Electronics. Select the fast, dependable way, from this new 260-page catalog.

NEWARK
ELECTRIC COMPANY

Dept. R-3, 223 W. Madison, Chicago 6, Ill.

WEST COAST BRANCH
4736 W. Century Blvd., Inglewood, Calif.

the finest

PRECISION ENGINEERED BY

Dynamic
ELECTRONICS

FOR BETTER RECEPTION

TELEVISION & FM ACCESSORIES
Tested and specifications certified by
New York Testing Laboratories, Inc.

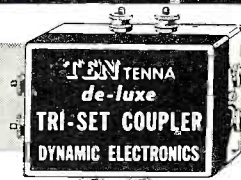

For highly efficient operation of any combination of 2 or 3 TV sets or FM Receivers from 1 Antenna of any type... absolutely no interaction.
• Less than 6 db insertion loss.
• 40 to 50 db rejection ratio.

Model No. T130 List \$7.50
Introductory Price **\$5.45**

SATISFACTION GUARANTEED OR
YOUR MONEY BACK

FREE An 8-page booklet packed with every "Dynamic" accessory. "How to recognize and remedy your TV and FM problems" ... Also improvement suggestions by eminent electronic engineers ... Edited by Dr. H. S. Bennett, D.S.C. in E.E.
AVAILABLE AT LEADING PARTS DISTRIBUTORS.

Manufactured by
DYNAMIC ELECTRONICS-NEW YORK, INC.
FOREST HILLS, LONG ISLAND, N. Y.

lead of the ohmmeter connected to the base, low resistance should be read to the collector and emitter. The collector-to-emitter resistance should be high irrespective of the polarity of the test leads. The complete reverse is true for *n-p-n* type transistors where the base is considered positive and the collector and emitter are negative. The collector-to-emitter resistance should still be high.

Speakers: A speaker and its voice coil can be tested by connecting an ohmmeter across the primary of the output transformer and listening for a "click" in the speaker. This, of course, cannot be considered as a quantitative test, but will indicate a dead output or an open voice coil. It is only effective in permanent-magnet type speakers. Incidentally, the approximate impedance of the voice coil of a speaker can be derived by multiplying its d.c. resistance by 1.1.

Testing meter movements: In a conventional ohmmeter, the center scale resistance on any range is the same as the internal multiplier resistance for that range. If a meter has a center scale reading of 10,000 ohms, for example, its internal resistance is likewise 10,000 ohms on that range. On the 100-ohm center scale, the internal resistance is 100 ohms. Each of these resistors is in series with the battery.

An ohmmeter which is pointing to 1000 ohms when this is the center scale position of a particular range would have about 1.5 milliamperes flowing through the test leads. (The battery voltage of 1.5 volts divided by the internal resistor of 1000 ohms.) If the ohmmeter leads were now connected to a milliammeter, the 1.5 milliamperes would flow through the meter under test, and a milliammeter in good condition should read 1.5 milliamperes.

If the needle on the low resistance range of the ohmmeter were used, considerably more current would flow through the test leads. For example, if 10 ohms were the center scale reading of an ohmmeter on a low resistance range, the current flowing through the leads would be 150 milliamperes. This, when fed to a milliammeter, might damage it. If you want to test a low current meter for continuity, always start at the highest ohmmeter range and work down. In such testing, a slight inaccuracy can be expected due to the internal resistance of the meter being tested.

General Comments and Precautions

The most common cause of trouble when using an ohmmeter is to forget to turn off the equipment under test, such as a radio or TV set. Remember that an ohmmeter is basically a resistor and battery in series. When it is connected from "B+" to ground on a TV set, a short circuit occurs. In a v.t.v.m. the meter movement would probably be protected by the tube. However, the internal resistor on the range used would probably be burned out.

Measuring high resistances: When the ohmmeter section is being used correctly, the most serious difficulty is associated with high resistance readings (millions of ohms). Here the operator is beset with several problems, the most important being how to connect the common lead. If it is connected very much above d.c. or a.c. ground certain inaccuracies develop due to stray pickup—this is primarily true of v.t.v.m.'s rather than multimeters. A small grid-to-ground bypass in the ohmmeter helps somewhat, but the easiest way of avoiding erroneous readings is to keep the common lead as close to d.c. or a.c. ground as possible.

If a grid-leak resistor is to be measured, the common lead should be brought to chassis ground and the ohms lead to the grid. In measuring the d.c. leakage in a plate-to-grid coupling capacitor it is necessary to disconnect one end of the capacitor from the circuit. This should be the grid side. The common lead is then connected to the plate side and the ohms lead touched to the open end of the capacitor. This follows since a plate load resistor is usually very much lower in resistance than the grid leak. Connecting the common lead to the plate side brings it closer to ground through the "B+" filters which are, practically speaking, a.c. ground. If the opposite connections were used, the common lead would be above ground by the resistance of the grid-leak resistor. It would now be subject to any extraneous pickup and leakages.

Although, in most cases, the aforementioned procedure is adequate, polarization of capacitors should not be discounted. When a capacitor is polarized, it will have a different ohmic reading upon interchanging the ohmmeter leads. In any capacitor, other than an electrolytic, a bad part is indicated. If a capacitor is suspected of being polarized, remove it and measure in both directions.

When measuring high resistances out of a circuit, hold the common lead in your hand. This again reduces the effects of stray pickup or leakage. You must make sure your other hand does not touch the uninsulated portion of the ohms lead or the resistance of your body will be included in the measurement.

In measuring a grid-leak or other high-value resistor without removing it from the circuit, an abnormally low resistance might be noted if the tube in the receiver has not cooled sufficiently. It is often a good idea to remove the tube or allow it several minutes to cool.

Greater than full scale readings: If an ohmmeter reads backwards or beyond full scale when testing a set, the probabilities are that the electrolytic or other capacitors have not been fully discharged. The best solution here is to short out the electrolytics and then wait. Make certain the short is eliminated before re-testing. —30—

March, 1956

Announcing!

New Sonotone "3" Series SUPER-FIDELITY Ceramic Cartridges

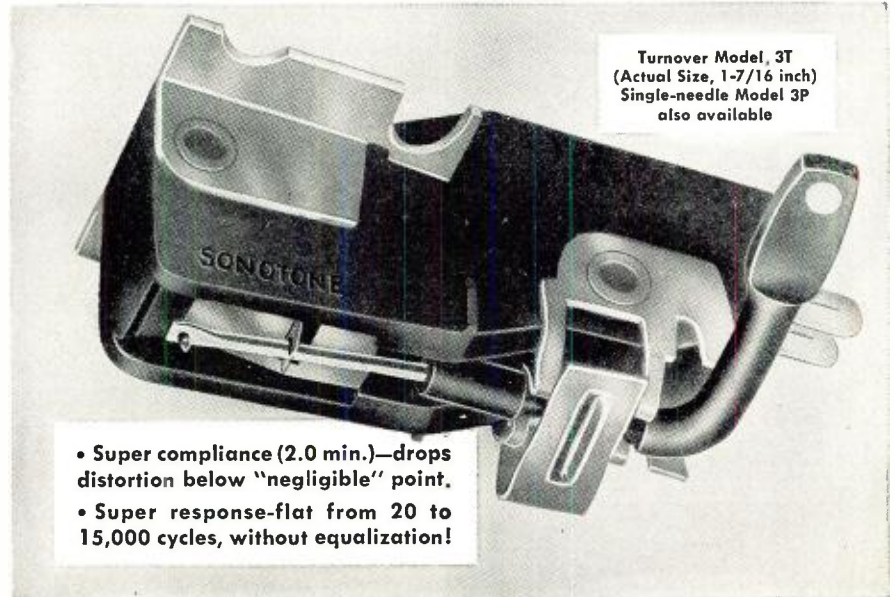

PARDON US IF WE CALL THEM "REVOLUTIONARY"...

but these new cartridges obsolete pre-amplifiers, equalizers, and old-style pickups!

If you've followed the development of ceramic cartridges since Sonotone pioneered them in 1946, you know we've made enormous advances.

Recently Sonotone has offered ceramic cartridges equal, by test, to most velocity types. Now, Sonotone presents the "3" Series, which set utterly new standards of finest performance, by all the measurements engineers know how to make.

These new cartridges make the *inherent* advantages of the ceramic type loom larger than ever. Consider:

WHY A PRE-AMP?

There is only one reason for a pre-amplifier—a velocity pickup puts out too feeble a voltage to drive your amplifier directly. But these Sonotone "3" Series cartridges deliver a whopping 0.5 volts—roughly 50 times as much as most velocity types. So you can *eliminate* the circuitry, noise, space and expense a pre-amp involves. (If you now have a pre-amp, our simple adaptor permits immediate use of Sonotone "3" Series cartridges in your present system.)

EQUALIZING UNNECESSARY

Sonotone "3" Series cartridges end equalization nuisance because ceramic cartridges respond to *amount* of needle movement not velocity. Result, they self-equalize.

These new cartridges eliminate mag-

netic hum problems. Fit any of the widely used arms.

Single needle model, with diamond, only \$30.00 LIST. Turnover model with sapphire-diamond needles, \$32.50 LIST. Less with sapphires.

NEW SONOTONE AMPLIFIER

We built this HFA-100 to realize the full excellence of Super-Fidelity ceramics.

Hum, noise and distortion are virtually unmeasurable—at maximum settings, distortion is only 0.15%! Cabinetry is superb solid walnut or solid mahogany, with solid brushed brass panel. \$117.50 NET. Similar control unit, for use with power amplifier, \$59.00 NET.

"Revolutionary" is a big word. But these Sonotone developments are pretty big news, if you like music!



SONOTONE®

CORPORATION, ELMSFORD, N. Y.



100 TUBES \$49⁵⁰

TUBES PREMIER Unconditionally Guarantees
All Tubes For One Full Year
Very Best Brands Available For Immediate Delivery, Individually Boxed.

1A5GT	6AT6	6U8	125G7
1A6	6AU4	6V6GT	125K7GT
1A7GT	6AU5GT	6V7	125L7GT
1B3GT	6AU6	6W4GT	125N7GT
1B3GT	6AV5	6W6GT	125Q7GT
1B5GT	6AV6	6X5GT	12Z3
1H6G	6AX4GT	6X8	140G
1L1	6AX5GT	7A5	148B
1L4	6B4C	7A6	14Q7
1L4A	6BA6	7A7	24A
1LA6	6BD6	7A8	25A6
1LC5	6BE6	7AD7	25AC5GT
1LC6	6BF6	7B1	25BQ6GT
1LD5	6BG6G	7B7	25C6G
1LH4	6BQ6GT	7B8	25W4GT
1LN5	6BQ6GT	7C1	25Y5
1N5GT	6BQ7	7C5	25Z5
1P5GT	6BY5G	7C6	27
1Q5GT	6C1	7C7	32L7GT
1R5	6C4	7E3	35/51
1S5	6C5GT	7E6	35A5
1T4	6C6	7E7	35B5
1U4	6C8G	7J7	35C5
1V	6CB6	7L7	35L6GT
1X2A	6CD6G	7N7	35Y4
3A4	6D6	7O7	35Z5GT
3B7	6D8G	7V7	39/44
3C6	6F6GT	7W7	42
3D4	6G6G	7X7	43
3Q5	6J6	12AT7	44
5U4G	6K6	12AU6	45
5Y3GT	6L6G	12AU7	45Z5GT
5Z3	6P5GT	12V7	46
6A7	6Q7GT	12AX4GT	47
6B8GT	6S4	12AX7	50AX6
6B4	6SA7GT	12AY7	50L6GT
6AB7	6SD7GT	12BA7	56
6AC5GT	6S5	12BD6	56
6AC7	6SJ7GT	12BE6	56
6AF1	6SH7GT	12BH7	56
6AG5	6SK7GT	12BG5GT	70L7GT
6AH6	6SL7GT	12J7GT	77
6AK5	6SN7GT	12Q7GT	78
6AK6	6SQ7GT	12S8GT	117L7GT
6AL5	6S57	12SA7GT	117Z3
6AQ5	6U7GT	12SC7	117Z6GT

ANY ASSORTMENT — TAKE WHAT YOU WANT
5c per tube extra for orders less than 100 tubes

NEW PICTURE TUBES

SIZE	PRICE	SIZE	PRICE
10BP4B	11.95	17LP4	21.95
12LP4A	13.95	17TP3	21.95
12UP4A	18.95	19AP4B	27.95
14BP4	18.95	19DP4B	27.95
14CP4	18.95	20CP4	26.95
16AP4	17.95	20DP4	26.95
16DP4A	19.95	20HP4	28.95
16EP4A	19.95	21AP4	27.95
16GP4A	19.95	21EP4	28.95
16JP4A	17.95	21FP4	29.95
16KP4	17.95	21MP4	29.95
16LP4A	19.95	21WP4	29.95
16RP4	17.95	21YP4	28.95
16TP4	19.95	21ZP4	27.95
16WP4A	19.95	24CP4	49.95
17BP4A	17.95	27EP4	27.95
*7CP4	21.95	27GP4	27.95
17CP4	21.95	27LP4	27.95
17HP4	21.95	27NP4	27.95

ALL TUBES THROUGH 21" GUARANTEED 1 YEAR
24" AND 27" GUARANTEED 6 MONTHS
Aluminized tubes \$4.00 additional

RESISTORS \$1.49 PER HUNDRED 200 for \$2.50

All good values, sizes and types 1/2-1-2 watts
-2% -5% -10% -20% Precision-Insulated Carbon
-Carbon-Deposited Carbon.

SURPRISE KIT \$1.98
10 lbs. Net of Reliable Radio and T. V. Parts—Each Kit includes a new Radio Cabinet—Good for 5 to 8 Tube Chassis.

CAPACITORS
molded Sprague
.001 @ 600V } **25 for \$1.25**
1 @ 400V }
40-40 } **10 for \$2.39**
120-50 }
10-10 }
60 } 450V }
150V } assorted

TUBE BRITENERS
89c each 10 for \$7.50

TERMS: 25% DEPOSIT with order, balance C.O.D.
ALL shipments F.O.B. Chicago. ORDERS LESS THAN \$5.00-\$1.00 SERVICE CHARGE. These prices supersede all previously advertised prices, subject to change.

PREMIER Write for FREE Bargain Catalogs
TV Radio Supply
3239 W. North Ave.
Chicago 47 • ARmitage 6-5550

Non-clipping Wave Squarer

By RICHARD H. DORF

Construction details on a versatile, easily-adjusted instrument designed especially for audio test work.

IT USED to be true that the principal use for square waves was for testing various pieces of audio equipment and now and then for an electronic switch used in conjunction with an oscilloscope. Today the band of uses for square waves has widened immeasurably, especially in the pulse techniques so vital in computer and other similar work. "Multivibrator" and "flip-flop" have become very familiar words in the technical vocabulary.

With all this, however, square waves remain very useful for audio testing—but the peculiar thing is that there are very few satisfactory ways of transforming the sine wave available from the usual audio generator into a really good square wave. The usual method employs clippers, the theory being that if you clip a sine wave and put flat tops on the two alternations very close to the base line (and then amplify the result) you will have a close approximation to a square wave. As a matter of fact, it is not really a very close approximation, since the hallmark of a good square wave or rectangular pulse is fast rise time—steep sides. Clipping a sine wave can never yield slopes any steeper than those of the original sine, even though with sufficient amplification and repeated clipping (requiring several stages and some involved circuitry) the rise time can be made fairly short with respect to the period of the wave.

The circuit shown in Fig. 1 produces a very good square wave (rise time less than 5 microseconds) at any frequency down very close to zero cps and up to about 100 kc. The frequency of the square wave is absolutely controlled by the fundamental of the input wave; and the input wave can be of practically any shape from sine to that produced by an oboe. It cannot oscillate of itself, and the output is always clean and rectangular irrespective of the input. Requirements for the input are modest in terms of amplitude, only 5 volts being required, while the output has a constant peak-to-peak value of about 100 volts for any input of 5 volts r.m.s. or more. At less than 5 volts input, there is no output whatever. The input source can have any impedance.

The circuit is in the nature of a bistable flip-flop; but unlike the usual flip-flop the output frequency is the same as the input so that the unit is not a frequency divider. Operation can be analyzed in the same way as that of a flip-flop.

A quick glance shows that the circuit is closed like that of an oscillator. The plate of V_{1A} is connected to the grid of V_{1B} and the common cathode resistor carries cathode output of V_{1B} back to the grid of V_{1A} . However, the over-all gain is below the critical point so there can be no self-oscillation.

At each of several points two voltages are indicated, one of them in parentheses. In analyzing, let us assume that the unparenthesized voltages are initially present. Let us apply a positive pulse to the input by touching to it a lead from the "B"-supply. Only a short flick is necessary, though the duration of the pulse does not matter.

V_{1A} is initially almost at cut-off. Because of the voltage divider R_1-R_2 across the "B"-supply, the grid is at plus 57 volts, while the cathode is at plus 75 volts (due to current through V_{1B} and the common cathode resistor). The grid is thus 18 volts negative with

Fig 1. Schematic of the wave squarer.

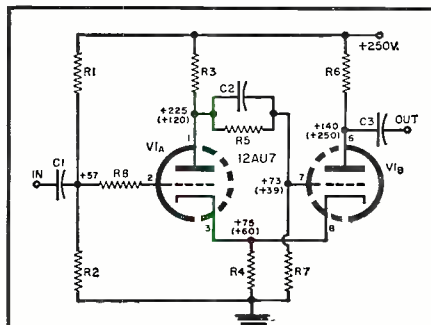

- R_1 —680,000 ohm, 1/2 w. res.
- R_2 —200,000 ohm, 1/2 w. res.
- R_3 —33,000 ohm, 1/2 w. res. $\pm 5\%$
- R_4 —15,000 ohm, 1/2 w. res.
- R_5 —330,000 ohm, 1/2 w. res.
- R_6 —22,000 ohm, 1/2 w. res.
- R_7 —150,000 ohm, 1/2 w. res.
- R_8 —10,000 ohm, 1/2 w. res.
- C_1, C_3 —.1 μ fd., 400 v. capacitor
- C_2 —50 μ fd. mica capacitor
- V_1 —12AU7 tube

ALL-TRANSISTOR!

AMERICA'S FIRST!

MODEL
TR-1

THE FISHER

ALL-TRANSISTOR

Preamplifier-Equalizer

WE ARE PROUD to announce the new FISHER All-Transistor Preamplifier-Equalizer, Model TR-1. This little giant is the result of four years of research and development and represents one of the greatest achievements in the long line of FISHER FIRSTS. We believe the TR-1 is the first all-transistor product of any kind in the high fidelity field. Its development was no accident, but rather the fruit of twenty years of leadership in audio technology. The TR-1 has NO hum. We repeat: ABSOLUTELY NO HUM. Second, it has NO microphonism. Other unique features of the TR-1 are listed below. The initial demand for this revolutionary device may exceed the available supply. To avoid disappointment, may we suggest that you place your order now.

OUTSTANDING FEATURES OF THE FISHER MODEL TR-1

- Can be used with any existing amplifier, audio control, or sound system. ■ Battery powered. Power consumption only 0.033 watts. Battery will last as long as it would when lying idle on a shelf! ■ Can be used as a phonograph or microphone preamplifier.
- Uniform response, within 2 db, 20 to 20,000 cycles.
- Built-in switch selects cartridge impedance.
- Handles all popular magnetic cartridges including very low-level type. Does not require transformer with the latter. ■ Hum level: *absolute zero!* ■ Noise level,

- 65 db below 10 mv input for high impedance cartridges. Better than 60 db below 2 mv for low impedance cartridges. ■ Incorporates RIAA equalization, now standard on all records. ■ Permits output leads up to 200 ft. ■ Three Controls: Power/Volume, Cartridge Impedance Selector, Phono-Microphone Selector Switch. ■ Uses three transistors. Printed wiring throughout. ■ Fully shielded chassis with bottom cover. ■ Attractive control designation plate.
- SIZE: 2" by 4" by 4½" deep. ■ WEIGHT: 12 ounces.

WRITE FOR COMPLETE DETAILS

FISHER RADIO CORPORATION · 21-23 44th DRIVE · L. I. CITY · N. Y.

**Easy
as pie!**



**HIGH FIDELITY
ARKAY KITS**
LABORATORY
TESTED



**Arkay FM-AM
Tuner Kit**

7 tube circuit plus selenium rectifier includes separate mixer and Oscillator stages, 3 double tuned IF stages with Foster-Seeley discriminator and grounded grid amplifier for excellent response characteristics:

Sensitivity & Selectivity—FM Suv for 30db quieting, 200 kc bandwidth 6db down. AM 25µv with 8 kc bandwidth 6db down.

Frequency response —
FM ± 5db 20-20,000 cps
AM ± 3db 20-5000 cps
Image rejection —30db minimum
Hum Level —-85db.

AFC control and defeat. **\$29.95**

Available in FM only. Model FM6

\$23.95

Write for technical information on this model.

**Arkay
FL-10 High
Fidelity Amplifier
Pre-Amp Kit;
Williamson Type Ultra-linear**

pushpull 12 watt output; frequency response ± 2db 20-20,000 cps with extremely low IM and Harmonic distortion; 5 position input selector with record equalizer; loudness, bass, and treble controls; tapped output; extremely low noise level; completely enclosed—no cabinet problem; for clean, flexible, brilliant audio.



\$28.95

**Arkay A-12
High Fidelity
Amplifier Kit
Featuring**

12 watt output—push pull 6V6's; frequency response ± 1db 20-20,000 cps with low distortion; 5 inputs, master controlled at front panel; tapped output transformer; separate bass and treble control, each with maximum db boost and cut; built-in Pre-Amplifier; ideal for home installations.

\$22.95

ARKAY MODEL PR-3

Amazing Miniature Radio
Featuring a superheterodyne circuit and hearing aid type ear piece, this radio kit, which has set the industry talking, receives the full AM band. 3 tube circuit brings in all stations clear as a bell and its plastic case measures only 5 1/4" x 3 1/4" x 1" as small as a pocket book.



\$12.95

**OTHER KITS
IN THE ARKAY LINE**

- Television Kits
- Testing Equipment • Phonographs
- Audio Amplifiers • Geiger Counters
- Experimenters Equipment • Radios

Visit your local distributor for these wonderful kits and write today for the special FREE Radio Kits Catalogue and list of dealers. Your copy will be sent by return mail with no obligation. Write to

**Radio Kits Inc., Dept. R-12
120 Cedar Street New York**

respect to the cathode and practically no plate current flows. Evidence of this is that the plate is at 225 volts, so that the drop across R_3 due to tube current is only 25 volts.

The positive pulse injected at the input to the circuit reaches the grid (pin 2) and causes a negative pulse at the plate. This pulse may be of fairly long duration because of the large value of C_1 , necessary to allow a sine wave to operate the device. However, it now passes through C_2 which is very small and differentiates the long pulse to give a very short, steep negative pulse at the grid of V_{1B} . Both the amplitude and, to some extent, the steepness of the pulse arriving at pin 7 are governed partly by R_7 since it is the resistance leg of the differentiator.

The steep negative pulse at the grid of V_{1B} produces a short, sharp reduction of plate current through V_{1B} , and the consequent sudden reduction of cathode current through R_1 produces a cathode pulse which is negative with respect to ground. It also, of course, makes the cathode of V_{1A} more negative with respect to its grid, so that effectively the V_{1A} grid is driven harder in the same direction as it was by our initial positive pulse. This action continues around the circle, snowballing, so to speak, until the d.c. voltage at the V_{1A} plate gets down to 120 (see parenthetical value), at which time the d.c. voltage divider R_5 - R_7 sets the V_{1B} grid voltage at plus 39. The cathodes are now at plus 60 volts (due to plate current through V_{1A} , which is less than it was through V_{1B} because of the larger plate resistor R_3), which means that the V_{1B} grid is 21 volts negative with respect to its cathode and plate current is cut off. That being the case, no further "snowballing" action can take place and the voltages at the time become fixed, constituting the second stable state. These are indicated in parentheses. Note that the V_{1B} plate has gone from 140 to 250 volts; this has taken place in less than 5 microseconds after application of the first touch of positive potential at the input grid. It therefore constitutes the leading edge of a very steep output wave with peak-to-peak amplitude of 110 volts. Since the input signal loses control after the first very brief instant during which it tells the V_{1A} grid only in which direction to go, the shape of the input signal has no effect on the shape or steepness of this output-voltage rise. The stable state indicated by the parenthesized voltages will remain until a negative voltage is applied to the input. If the input is a.c., this means that there will be a positive flat top on the output wave during the entire positive input alternation.

When a negative pulse is applied to the input, either by flicking it with a lead from a negative voltage source or by the fact that an a.c. input voltage begins to go negative, the same action takes place in the other direction. A positive pulse occurs at the V_{1A} plate, which puts a short positive pulse on the V_{1B} grid. This produces a brief

pulse of current through V_{1B} , causing the cathode voltage to become more positive. As a result the grid of V_{1A} goes even more negative, the action snowballing until the first stable state is reached again, with the plate of V_{1B} at plus 140 volts. This causes the output to have a steep negative-going trailing edge and completes the first rectangle of its shape. When viewed on an oscilloscope, the output pulse rises are so fast they cannot be seen until frequencies are reached where the response of the scope causes significant attenuation of harmonics. The flat tops are perfect, of course, down to d.c., limited only by the value of C_3 , the output blocking capacitor, and whatever load is placed on the output.

The uses for this interesting circuit extend beyond the obvious ones of testing response and transient characteristics of amplifiers. One is automatic detection of the fundamental in a complex wave. An especially interesting experiment showing this is to apply the output of a microphone amplifier to the circuit. When the microphone picks up voice or an instrument (one tone at a time) the tone complexities disappear and a perfect rectangular wave of the fundamental (or in a few cases the most prominent harmonic) appears. Frequency comparison is facilitated in cases where high harmonic content or noise in the wave to be measured is a nuisance; the circuit eliminates the complexity of harmonics and takes out all noise. It will operate as a mixer or detector to present a difference frequency between two presented to its input, no filtering being required.

In its primary use, audio, however, it is especially good because it is so small and simple. It can be placed within the case of just about any audio generator without taking up too much room or drawing too much power, and it will give a far better square wave at all frequencies than the usual clipper ever can.

The values and voltages, as shown, give a practically perfectly square wave and allow operation at d.c. (brief manual application of input potentials). For practical use in testing, however, where d.c. operation is not necessary and the output need not be a perfect square (that is, durations of positive and negative pulses need not be just equal), there is considerable latitude in values. The "B"-voltage can be anything that happens to be available. As a matter of information, the output wave symmetry can be adjusted with the values of R_7 and R_5 . If output amplitude is too high a voltage divider, consisting of a potentiometer of around 100,000 ohms or more, with the ends connected to ground and C_3 , and the arm carrying variable-voltage output, can be placed across the output. Loading should be limited to a minimum of 70,000 ohms or so to avoid destroying the symmetry of the output square wave. Loads below about 30,000 ohms will cause operation to stop.

—30—

100—156 MC TRANSMITTER & RECEIVER—SCR-522 TRANS. & RECEIVER—100—156 MC, 4 Channel, Crystal Control, AM Voice Operation, 18 Tubes—Trans.: 2/832, 3/12A6, 1/6S57, 1/6G6—Rec.: 1/9002, 1/9003, 3/12A6, 2/12AH7, 1/12C6, 1/12H6, & 3/12SG7. Complete with Tubes, Schematic, and Conversion Info. for ama-
\$34.95
 rec use—Good Cond. \$19.95
 REC.—Chassis Only, w/Tubes: \$19.95—
 Less Tubes: \$9.95
 TRANS.—Chassis Only w/Tubes: \$22.50—
 Less Tubes: \$9.95
 SCHEMATIC and Conversion Info. Only: \$2.50

FM TRANSMITTER
27 to 38.9 MC
 BC-924—TRANSMITTER: Four preselected Channels, M.O. Control, 30 Watt slug tuned Coils, high & low Switch. Uses 2/815 tubes, 2/6S17, 1/6SL7, 1/6V6, 1/6J5, 1/6AG7, 1/VR-150. Voltage required 12 or 24 V. and 400 V. @ 400 MA. Size: 11" x 11" x 11".
\$24.95
 18". With Schematic NEW:

BROADCAST RECEIVER

NAVY TYPE—520-1500 KC. NEW: \$19.95
 LIKE NEW: \$14.95
 Q 5 or NAVY TYPE—190-550 KC. NEW: \$12.95
 R-28/ARC-5 RECEIVER—100-156 MC. USED: \$10.95
 T-23/ARC-5 TRANSMITTER—100-156 MC. Used. \$14.95
 NAVY TYPE COMMAND TRANSMITTER—2.1-3 MC. New: \$7.95; Used: \$5.95
 NAVY TYPE COMM. TRANS.—3.4 MC. USED: \$6.95
 BC-458 TRANS.—5.3-7 MC. New: \$5.95—USED: \$3.95
 Navy Type Trans.—7-9 MC. New: \$7.95—Used: \$5.95
 BC-1206—200 to 400 KC. \$9.95

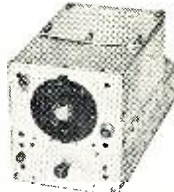

CLASSIFIED ITEMS:

BC-212G Amplifier—2/6C5 tubes. NEW: \$ 1.95
 BC-216 Amplifier—6F7 & 39/44. USED: 1.50
 BC-229/429 Receiver—2500-7700 KC w/Coils. U: 6.95
 BC-230 Transmitter—2500-7700 KC w/Coils. U: 8.95
 BC-347 Amplifier—1/6F8G tube. N: \$3.95; U: 1.95
 BC-357 Beacon Rec.—75 MC. N: \$4.95; U: 2.95
 BC-367 Amplifier—2/6V6 tubes. N: \$4.95; U: 2.95
 BC-375 Transmitter Used: 29.95
 Tuning Units f/BC-375; TU-5-6-7-8-9-10-26.
 U: Ea. 2.95
 Cables f/BC-375/BC-191, PL-61, 64, 59 ea. Ea. 2.75
 BC-442 Antenna Relay Box—w/Cond. New: 2.95
 BC-500 Trans. & Receiver—25 Watt, 20-28 MC. 59.50
 BC-604 Transmitter—20 to 28 MC. Used: 9.95
 SCR-625 Mine Detector—Reconditioned. 39.95
 BC-654 Transceiver—3800 to 5800 KC. Used: 34.95
 RM-21 Remote Control Box f/BC-669. 4.95
 CD-515 Cable F/BC-669. 2.75
 BC-709 Amplifier—Batt. Operated. New: 1.95
 BC-745 Transceiver—3 to 6 MC. Used: 14.95
 BC-966 1FF—160 to 211 MC. 13 tubes. Used: 5.95
 BC-1158 Transmitter, 50 Watt, 53.3-95 MC. New: 39.95
 BC-1206 Receiver—200 to 400 Kc. New: 9.95
 RI/ARR-1 Receiver—Converts to 2 or 6 Meters 2.95
 RT-7/APN-1 Altimeter—140 MC. Used: 9.95
 RT-34/APS-13 Transcvr. Comp. less tubes. U: 3.95
 T-121 Transmitter—3-4 MC with Coder. 9.95
 Range Beam Filter, Navy Type \$1.95; FL-8 Used: 1.49
 EE-8 Field Telephones—Checked. Used: 14.95
 RM-12 Radio-Telephone—Remote Control. Used: 19.95
 BD-72 Portable 12 Line Switchboard. Used: 39.95
 Sound Powered Head & Chest Set—Checked. 3.95
 Sound Powered Head & Handset f/Mark II. Used: 2.95
 TS-9 Handset w/Switch—No Plugs. New: 3.95
 TS-15 Handset w/Switch, PL-68 & PL-55. New: 7.95
 TS-13 Handset w/Switch, PL-68 & PL-55. Used, Ckd. 5.95
 T-17 Microphone—Clean, Used, Checked. 3.95
 HS-30 Headset—Hearing Aid Type. L.N. 1.50
 CD-874 Cord—f/HS-30—Low Imp., w/PL-55. U: .59
 CD-605 Cord—f/HS-30—High Imp., w/PL-55. N: .79
 CD-307 Cord—w/PL-55 & JK-26.59
 CD-318 Cord—2/PL-68, JK-48, & SW-141. U: .89

ANTENNA EQUIPMENT

MAST BASES—INSULATED:

MP-22 BASE—(Illustrated) Ins. spring action; direction of bracket can be raised or lowered **\$2.95**
 easily.
 MP-S-33 BASE—Insulated type with heavy coil spring and 5" dia. Ins. Requires 2" hole for mounting. Weight: 9 lbs. **\$5.95**
 MP-48 BASE—Insulated type base with heavy coil spring. Requires 1 1/2" mounting hole. Weight: 11 lbs. **\$4.95**

MAST SECTIONS FOR ABOVE BASES:

Tubular steel, copper coated, painted in 3 ft. sections, screw-in type. MS-53 can be used to make any length with MS-52-51-50-49 for taper. Any section. @ 50¢ Each
 Larger Diameter Section: MS-54. 75¢

TRANSFORMERS—115 V. 60 CYCLE PRI.:

600 VCT/100 MA—6.3 V/5 A.; 5 V/3 A. \$4.95
 350 VCT/40 MA—6.3 V/2.4 A.; 6.3 V/1.6 A. (Rect. 6 x 5) 1.75
 1500 VCT/350 MA—6.3/6A; 6.3/2A; 5V/2A. 8.95
 1300 VCT/350 MA—5 inches Sq. 6.95
 940 VCT/500 MA—6" x 5" x 5". 5.95
 700 VCT/150 MA—5 V/3 A.; 6.3 V/4.5 A. CSD. 3.95
 2500 V/12.5 A.; 2.5 V/17.5 A.; 6.3 V/6 A. 5.95
 1800 V/12.6 MA—Tapped 2.5 V 2 A. 5.95
 1100 V/80 MA—7.5 VCT/3.25 A. 5.95
 720 VCT/50MA—6.3V/2.5 A—5V/2 A. 2.50
 662 VCT/110 MA—6.3V/2 A—5V/2 A. 3.95
 800 VCT/300 MA—12.6V/10 A—5V/3 A. 6.95
 30 V—1 Amp. \$1.50; 24 V—1 Amp 1.50
 9 Volt CT—35 Amp.—Tapped 4.5 V. 7.95
 12 Volt—Two separate windings—4 amp each. 5.95
 28 Volt 8 Amp—Tapped 4 Volt. 5.95
 5 V/2 A.; 5 V/2 A.; 5 V/2 A.; & 5 V/6 A. 2.95
 600-0-600 VAC—200 MA. 12.5 V. 2 A.; 12.5 V. @ 2 A.; 5 V. @ 3 A.; #H-108—Price. 8.95
 250-0-250 VAC—50 MA. 24 V. 1 A.; and 6.3 V. 1 A. #H-109—Price. 4.95

Choke—12.5 Hy/100 MA. \$1.95
 Choke—5 Hy/200 MA—80 Ohm. 1.25
 Choke—8 Hy/150 MA—200 Ohm—Open Frame. 1.25
 Choke—5 Hy/150 MA—85 Ohm. 1.50
 Choke—10 Hy/250 MA—2 3/4" x 2" x 3" Potted. 4.95
 Choke—5 Hy/400 MA—4 1/2" x 4" x 5 3/8". 4.95
 18.4 Hy. 1 Amp 100 Ohm—7 1/2" x 5 1/2" x 6 3/4". 6.95

NOTE—For Items Previously Advertised, See Our Classified Section At Left!

PANORAMIC ADAPTER And OSCILLOSCOPE

1D-60/APA-10—Two units in one Panadapter & Scope with three inputs for feeding 1F Freq. of 455 KC. 5.2 MC, or 30 MC from receivers for viewing on 3" scope tube. Can also be used as regular scope; has vertical and horizontal push pull Amplifier inputs. Complete with 21 Tubes. Operates from 115 V. 400 cycle New: **\$49.50**

METERS:

WESTON AC AMMETER:
 (Pictured) In portable leather case, with Test Leads, 2 1/2", 0-15 AC and 0-3 AC Scale. **\$5.95**

DC AMMETER HOYT: In portable metal case, with Test Leads, 4 1/2", Fan Mirrored Scale 0-15 ADC. \$4.95
 DB METER—10 to Plus 6, Westinghouse 3", NC-35 Imp. 600 ohms @ 1000 cycle. 4.95
 0-3 RF AMMETER IS-128; 2 1/2" Rd. NEW: 2.95
 0-8 Amp RF w/Thermocouple IS-89; 2 1/2" Rd. 4.95
 0-15 AC-DC—2 1/2" Rd.; IS-122. 4.95
 0-500 MA DC—2 1/2" Rd.; IS-22. 4.95
 0-150 V. 60 cycle; Simpson; 3 1/2" Rd. 3.95
 0-250 MA DC—DeJurr, 3" Sq. 3.95
 OUTPUT—5 Ranges, 4000 ohm Imp.—Used. 4.95



TRANSCEIVER 20—80 MC.

NAVY TBY WALKIE-TALKIE TRANSCEIVER—20 to 80 MC. in 4 Bands, providing Voice or MCW. For short range operation with Crystal Calibrator for checking Freq. Trans. Oscillator Modulation & 958, 1E7, & #30 Tubes. Rec. is super-regenerative, using 958 & 959 Tubes. Voltage required for operation: 150 V "B" 3 V "A" tapped 1.5 V & 7.5 V "C." Complete with Tubes, Schematic, & Conversion Info. **\$19.95**
 Good Condition

TG-34A KEYSER

TG-34A KEYSER—115 or 230 Volts at 50 to 60 cycles—an automatic unit for reproducing audible code practice signals previously recorded in ink on paper tape. By use of the self contained speaker, the unit will provide code practice signals to one or more persons—or provide a keying oscillator for use with a hand key. Unit is compact in portable carrying case, and complete with Tubes, Photo Cell and Operating Manual. Size: 10 1/4" x 10 1/2" x 15 1/8". Shipping weight: **\$16.95**
 45 lbs. NEW:

TG-10 KEYSER—Same function as TG-34A—only larger—using 2/6N7—2/6L6—2/6SJ7—1/5U4G Tubes and 1/923 Photo Cell. Housed in standard Metal Cabinet, can be removed for 19" rack mtg. Size: 11" H x 24" W x 18 1/2" D. **\$14.95**
 Price—USED, TESTED. Only

BLANK PAPER TAPES FOR CODE RECORDERS:

3/8" Wide, in 900 Foot Rolls—Prices: 25¢ Each—or 6 Rolls f/\$1.00—30 Rolls f/\$3.00—60 Rolls f/\$5.00

NOW—OPERATE BEACON RECEIVER FROM 12 VOLT

BC-1206CM BEACON RECEIVER: 200-1100 KC, 5 Tubes, 135 KC 1F, operates from 24 VDC—**\$9.95**

For 12 Volt operation, use this PM DYNAMOTOR—12 VDC input, output 24 VDC. Size: 2 1/2" x 4" x 7" Dyn. **\$4.95**
 Combination: BC-1206 & Dynamotor. \$12.95

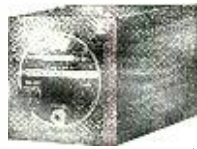

DYNAMOTORS & GENERATORS:

DM-42 Heavy Duty Mobile DYNAMOTOR: 14 V. input; output 1030 VDC—260 MA & 515 V. 215 MA. @ 6 VDC. Approx. half of Voltage. Prices: NEW: \$9.95—Used: \$4.95.

INPUT VOLTS:	OUTPUT VOLTS:	MA.	STOCK NO.	PRICES: USED: NEW:
12 VDC	220	80	DM-34	\$2.95 \$ 4.95
12	625	225	DM-35	8.95 12.95
12	230	90	PE-133	4.95 6.95
12 or 24	230	100	DA-12	8.95
12 or 24	540	450	DA-14	14.95
14	375	150	BD-83	3.95 4.95
14 VDC	330	150	BD-87	3.95 5.95
14	250	50	DM-25	6.95 8.95
14	1000	350	BD-77	14.95 29.95
24	250	60	PE-86	8.95
28	1000	350	PE-73	8.95

12 to 24 VDC PM Dynamotor—Supplies 24 VDC 2 A. from 12 VDC, also 500 V 50 MA. @ 6 VDC will supply 12 VDC & 250 V 50 MA. **\$4.95**
 #0515 New:
 GN-45 HAND CRANK GENERATOR—Supplies 6.3 VDC and approx. 250 to 500 VDC. Complete with legs, seat and Hand Cranks which have to be turned 50 to 70 RPM to supply voltage (Used with BC-654) Complete Set: **\$9.95**

HIGH FREQUENCY RECEIVER

R-74/CRW-2 RECEIVER—53 to 88 MC—For remotely controlled radio systems on preselected freq. Complete with tubes: 1/6SN7, 3/6SL7, 1/6SG7, 1/6J5—**\$9.95**
 & 24 Volt Dyn. Size: 9 1/2" x 8" x 4 1/2". NEW:

TRANSMITTER & MODULATOR
67 to 74 MC

BC-463—20 Watt, Crystal Control—Complete with 16 Tubes: 1/815, 8/12J5, 2/12SN7, 2/6V6, 2/6L6, & 1/VR-150. Also Output Meter, Crystal Modulation Trans., Motor, & Fan. USED: **\$16.95**

Address Dept. RN, \$5.00 Order Minimum & 25% Deposit on C.O.D.'s. Prices are F.O.B., Lima, O.
FAIR RADIO SALES 132 SOUTH MAIN ST. LIMA, OHIO

LMB BOX CHASSIS

Flangelocking Precision Engineered

65 sizes and shapes for the laboratory, manufacturer, industrial, experimenter, builder, and general applications where metal boxes are required. Stocked by all electronic and geophysical distributors. Send for free catalog.

LMB 1011 Venice Blvd. Los Angeles 15, Calif.

Latest HICKOK Tube Tester Roll-Chart

To keep your HICKOK Tube Tester up to date, HICKOK reprints new roll-charts every 6 months. Easy to install. Send \$1 . . . Be sure to specify model number of your HICKOK Tube Tester.

THE HICKOK ELECTRICAL INSTRUMENT COMPANY
 10524 Dupont Ave. • Cleveland 8, Ohio

TELEVISION

PREPARE FOR A GOOD JOB!
 BROADCAST ENGINEER
 ELECTRONICS RADIO SERVICING

Television Servicing

(Approved for Veterans)
 SEND FOR FREE LITERATURE
BALTIMORE TECHNICAL INSTITUTE
 1425 EUTAW PLACE, BALT. 17, MD.

A.... Always
B.... Buy
C.... Columbia

\$64,000 QUESTION !!!
Why buy a volubator alone when rootin' footin' Columbia gives you a whole APX-1 for the same price?

ARC-7 AR-1 TRANSCEIVER
Good for conversion to 420 MC band or use components to build sweep generator. Less tubes and some minor parts. Excellent condition. \$2.95

R-4/ARR2 RECEIVER
Hi-gain receiver for conversion to 220 MC. With all tubes. Used. excellent condition. \$1.95

ARC-4 VHF TRANSCEIVER!
For 2-meter, CAP. novice, etc. Excellent condition. With tubes and crystals. \$19.50
AC POWER SUPPLY: for above ARC-4. 9.95
COMBO PRICE: Both units only. \$27.50
NOTE: See "Converting the ARC-4" story Page 40, Nov./55 C.Q.

**YOU WANT IT CHEAP????
A BUCK OR LESS!**
CITIZENS' BAND & 420 MC ANTENNA SYSTEM. New. 95c
7 FT TELESCOPIC ANTENNA: Collapses to 12". Makes terrific portable vertical. New in box. 88c
HOFMAN SILVER CIRCLE TV TUNER: as is cond. But has a \$13.00 Vernier built in. Makes great 6 & 2 meter converter. Now will you buy 5 for \$1.00
4-CHANNEL PUSH-BUTTON FRONT END: For 2-6 MC receiver. Only needs 455 KC IF tubes and audio section. New in original box. 3 for \$1.00. Each. 39c

Original AC Power Supply. \$19.95
For LM Freq. Meter. Excel.

APX-1 TRANSCEIVER
Loaded with all kinds of useful parts: miniature tube sockets, relays, switches, condensers, resistors, etc. P.L.U.S. 3-speed Bar-B-Q motor. Regular value \$9.95. How can you beat it for only. \$2.49

ELECTRO-LYTIC CONDENSER: 1,000 mfd. @ 15 VDC P.P. good for hobbyist or photo flash. \$4.00

6 TUBE SPECIALS

6S750c	1629\$.15
6V660c	3B1 CRT1.95
80775c	6K739

MD-7 PLATE MODULATOR
For ARC-5. Uses 2 ea. 1625 for push-pull modulation. With tubes. New. Boxed. Ea. \$7.95
USED, but in excellent condition. Ea. \$4.50

ASTATIC CRYSTAL MIKE
Model 200-S. With stand and on-off switch. Lists at \$15.00. Brand new. Your cost. \$6.95

3-SPEED RECORD PLAYER
New manufactured by nationally known company. Portable in cute case. \$22.95

**LONG TIME NO SEE!!!!
DM-35 Mighty Mite 12V.**

Mobile Power Supply
Delivers over 130 V. to final. So small will actually fit glove compartment. Output voltages 625 V. @ 225 MA. These are brand new. And confidentially, you won't have to worry about THESE bearings! Brand new. \$12.49
Guaranteed. 2 for only \$21.00

OIL CAPACITORS! ALL BRAND NEW!

Mfd	WVDC	Price	Mfd	WVDC	Price	Mfd	WVDC	Price
1	400	\$.10	5	600	\$.49	2	1,000	\$.49
4	500	.30	6	50	1.00	1.49		
1	600	.29	7.5	600	.69	15	1,000	2.49
2	600	.35	8	600	.79	5	1,500	.49
			10	600	.89	1	1,500	.69
4	600	.39	30	600	1.95	8	1,500	1.95
3	for \$1.00		42	600	2.95	5	2,500	.95
			1	1,000	.39	5	7,500	3.95

Command Xmtrs @ Command Prices!
All complete with tubes!
3-4 MC. Xmtr. Used. excellent. \$ 7.95
4-5.3 MC. Xmtr. Used. excellent. 2.95
5-3.7 MC. Xmtr. Used. excellent. 2.95
7-9.1 MC. Xmtr. Used. excellent. 3.95
7-9.1 MC. Xmtr. New. Boxed. 5.95
T-23/ARC-5 VHF Xmtr. with tubes. 14.95

COMPLETE 50 FT. ANTENNA MAST
4" O.D. Hollow center to provide for coax lead of rotator shaft. Dis-assembled, it collapses to five 11 ft. sections. Comp. with all hardware, base, top, corkscrew guy anchors, ground stake. New in overseas crate. 4 of these make terrific rhombic antenna. Package deal: 4 units for \$69.95. Truck shipment only. \$19.95
Each

**ALL NEW
40 METER PACKAGE DEAL**
1 ea. new cond. 6-9.1 Receiver
1 ea. new boxed 7-9.1 MC Transmitter
1 ea. new MD-7/ARC9 Plat Modulator. With all tubes!
SPECIAL PRICE ALL 3 UNITS. \$19.95

NOVICES! 2 METER SET-UP!
ARC-5 TRANSMITTER AND RECEIVER. Crystal control with modulation power supply. Complete. Excel. cond. \$24.50

DUAL VOLTAGE GENERATOR: 12 VDC, 25 amps; 1,000 VDC, 350 mills. New, boxed. Ship. wt. 10 lbs. \$9.95

COILED MIKE CORD
More stretch than a rubber check! Collapses to 24 inches and extends to 11 feet! New. Ea. 79c 3 for \$2.00

ASK FOR NEW ANNIVERSARY CATALOGUE!
All orders FOB Los Angeles. 25% deposit required. All items subject to prior sale. MINIMUM ORDER \$30.00.

OPEN FRIDAY NITE TILL 10 P.M.

ELECTRONICS
2251 W. WASHINGTON BLVD.
LOS ANGELES 18, CALIFORNIA

BANDSWITCHING WAVEMETER

By ROBERT J. ROPES, W9PAP

THIS all-band bandswitching wavemeter can be built at very little expense, using parts from the junk box and the surplus markets. The circuit is "sure-fire," contains no tricky circuits, and requires no special precautions in building. The whole unit can be built in three hours' time. The wavemeter is not intended to measure precise frequencies, but is utilized mostly to check outputs of transmitters and variable frequency oscillators, etc., to determine whether operation is occurring in the desired band. Correct use of this instrument precludes the possibility of accidentally "doubling" in the final amplifier when straight-through operation is desired, and meets with FCC regulations regarding frequency checks of the transmitter.

The wavemeter is easily built into a 5" x 7" x 3" Bud chassis (Bud Part #AC-429), cutting a back cover from aluminum sheet. The pickup antenna is a piece of copper or aluminum tubing about 12-inches long mounted on a stand-off insulator. Aluminum clothes-line wire will work satisfactorily if tubing is not available.

The coil was wound on a 1-inch diameter form and occupies a winding length of 1 7/8 inches. If a 1-inch form is not found in the junk box, other size forms can be used, but the total number of turns and the number of turns between taps will have to be adjusted accordingly.

A nice deflection at the fundamental frequency, at distances of several feet from low power oscillators and amplifiers, is obtained. Exercise caution when checking near high voltages, since a severe shock is possible if a high voltage terminal is accidentally touched with the antenna pickup.

If the instrument is to be used near high voltages, it would be wise to wrap the antenna with several layers of plastic tape.

A dial can be made from a 3" x 5" index card, glued to the front "panel," and calibration marked in with India ink.

-30-

Schematic of the inexpensive wavemeter.

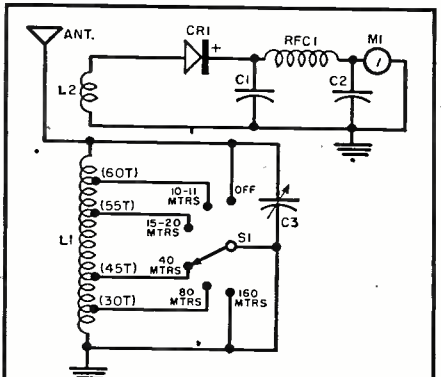

- C1, C2—.001 µfd. mica capacitor
- C3—140 µfd. var. capacitor
- CR1—1N34A crystal diode
- RFC1—2.5 mhy. r.f. choke
- M1—0-1 ma. d.c. meter
- S1—Rotary switch (Mallory Type 1311L)
- L1—65 t. #24 solid copper enameled wire, closewound on 1" dia. form. Taps at 30, 45, 55, 60, and 65 t. from ground end
- L2—15 t. # 28 solid copper enameled wire, closewound on "antenna" end of coil. Wind directly over L1 insulating between layers with one layer of cellophane tape

**NOW ULTIMATE PERFECTION
IN TONE ARM PERFORMANCE**

Ortho-sonic V/4
TRACKS COURSE OF ORIGINAL RECORDING STYLUS



**VITAL ENGINEERING
PRINCIPLE SOLVED!**

TRACKING ERROR ELIMINATED
FLAWLESS REPRODUCTION ATTAINED. Stylus moves in straight line from edge to center as originally recorded.

INSPIRED DESIGN: Increases record life . . . fits smallest cabinet . . . plays all size records . . . no scratching possible . . . all popular cartridges fit.

Never before in the history of Hi-Fi development has the introduction of a single component created such wide interest, laboratory and editorial endorsement. Get ORTHO-SONIC V/4 with its 10 incomparable features. **ONLY \$44.50.**

AT BETTER HI-FI DEALERS EVERYWHERE

Write For Illustrated Literature

ORTHO-SONIC INSTRUMENTS, Inc.
66 D Mechanic Street, New Rochelle, N. Y.

**Build
your own
PRE-AMPLIFIER!**



Mail coupon below for free article "Pre-Amp with Presence" by C. G. McProud, Audio Magazine— together with other pre-amplifier circuits featuring the outstanding

**Genalex
Z729**

lowest hum, lowest noise, high-gain input Pentode on the market.

About the Z729...

- Total hum voltage infinitesimal . . . actually less than 1.5 microvolts.
- Expressly designed for use as first stage of high gain amplifier or tape recorder.
- Internal shield completely surrounds tube elements.
- Fits standard 9 pin miniature tube socket.

Quality Endorsed Product of the British Industries Group.

British Industries Corp. Dept. XC-46
80 Shore Road, Port Washington, N. Y.
Please send Circuit Design and literature on the Z729

Name
Address
City Zone State

Within the Industry
(Continued from page 28)

tion. He succeeds Col. Allen E. Wharton of the *New Jersey Bell Telephone Company* in the post.

Vice-presidents elected at the annual meeting include Henry R. Bang of *New York Telephone Co.*; Col. Ludwig R. Engler of *RCA Communications, Inc.*, and Col. Benjamin H. Oliver, Jr. of *American Telephone and Telegraph*. Major Theodore N. Pope of *Bell Telephone Laboratories* was named treasurer; Lt. Col. David Talley of *Federal Telephone and Radio Co.*, secretary, and Royal F. Jewett of *Western Electric Company*, recording secretary.

* * *

SNYDER MANUFACTURING COMPANY is celebrating its silver anniversary this year with the original owners, Ben and Gus Snyder, still heading the firm.

From a modest beginning in a store front and basement location the antenna company has grown until it now occupies over 150,000 square feet of floor space at 22nd and Ontario Streets in Philadelphia in addition to a plant in Canada and two subsidiary firms.

* * *

IRE's Professional Group on Industrial Electronics, the Central New York Section of the ISA, and the AIEE Committee on Magnetic Amplifiers are co-sponsoring a special technical conference on magnetic amplifiers which is to be held April 5th and 6th at the Syracuse Hotel in Syracuse, N. Y.

Technical sessions, a manufacturers' exhibit of magnetic amplifiers, components, and associated products, and a banquet on Thursday evening are planned. Dr. Oliver G. Haywood, director of *Sylvania's* Waltham Laboratories, will be the banquet speaker.

Full details on exhibit space are available from S. Seely, Dept. of Electrical Engineering, Syracuse U., Syracuse, N. Y. For other information on the conference, write C. F. Spitzer, Bldg. 3, *General Electric Co.*, Electronics Park, Syracuse, N. Y.

Registration fee is \$3.00 for the conference with banquet tickets \$5.00.

* * *

R. C. SPRAGUE, founder and chairman of the board of *Sprague Electric Co.*, has been named chairman of the Federal Reserve Bank of Boston and its fiscal agent. He was deputy chairman of the bank in 1955.

* * *

DR. ALAN M. GLOVER has been appointed general manager of the newly-created semiconductor division at *Radio Corporation of America*. A new three-million-dollar plant is now being erected at Somerville, New Jersey, to house the division. . . **S. ARTHUR LOEB**, chairman of the executive committee, *Webster Electric Company*, Racine, Wisconsin, passed away recently at his home in San Diego, California. He was 69 years old. . . *Collins Radio Company* has announced the appointment of **DR. HAROLD V. GASKILL** of Iowa
March, 1956



BEST FOR COLOR TEST!



**MODEL 617
3" OSCILLOSCOPE**

The most for your scope dollar. Flat-face CRT gives edge-to-edge accuracy . . . laboratory precision *plus* field ruggedness. And at your electronic jobber, it's just . . . \$269.50.

There's just one way to test the new color TV sets... WITH NTSC COLOR PATTERN. That's what Hycon's Model 616 Color Bar/Dot Generator offers... *all* standard colors, sequences and patterns easily selected and graphically shown *in actual color* right on the control panel. For color TV, get ready... GET HYCON!

"Where Accuracy Counts"
Hycon ELECTRONICS, INC.
A Subsidiary of Hycon Mfg. Company

321 SOUTH ARROYO PARKWAY
PASADENA, CALIFORNIA

MAIL,
please,
for Catalogs
616 and 617

HYCON ELECTRONICS, INC. Dept. U
P.O. Box 749 Pasadena, California
Please send me the new model 616 and 617 catalogs.

Name _____

Address _____

City _____ State _____

TEST and REPAIR

PICTURE TUBES
 "Right on the Job"
CENTURY'S CRT
TESTIVATOR



ONLY
14.95

- New Profits!
- More Sales!
- Saves Time!
- Saves Trouble!

With the Model 103 CRT TESTIVATOR you can repair picture tubes right in the set in a matter of minutes. The TESTIVATOR tells you INSTANTLY what the trouble is and THEN FIXES IT!

IT TESTS: Cathode emission • Shorts and leakage between elements • Open elements • Probable useful life of the tube.

IT REPAIRS: Activates the CRT cathode by removing surface contamination • Restores emission giving life to weak and dim tubes • Clears inter-element shorts and leakage.

So easy to use . . . you just plug in, attach the TESTIVATOR socket to the base of the CRT and the accurate, easy-to-read indicators tell you what you must know. (Complete cables and instructions included.)

FREE BONUS—Order now and receive a handy, valuable booklet listing radio and TV tubes (incl. CRT) which can be substituted with **NO WIRING CHANGES**. Another profit maker for you.

10 Day Free Trial—Money Back Guaranteed

-----NOW! PAY AS YOU EARN-----

CENTURY ELECTRONICS CO., Dept. RN-3
 111 Roosevelt Ave., Mineola, N. Y.

Enclosed is \$5.00 down payment. Please send me . . . Model 103 CRT TESTIVATOR. After 10 days, if not completely satisfied, I will return it for a complete refund—Or I will send \$5.00 a month until the full price of \$14.95 plus postage is paid.

Name

Address

City State

SAVE SHIPPING CHARGES! Enclose \$14.95 with this order . . . then we pay the shipping costs. Same refund privileges.

State College to the post of vice-president in charge of planning. He has been dean of the Division of Science and Director of the Industrial Science Research Institute at the college since 1938 . . . **JOSEPH A. FRABUTT**, general sales manager of *Federal Telephone and Radio Company*, has been named vice-president in charge of the company's Pacific Division in Los Angeles . . . Appointment of **ALBERT HANSEN, JR.** as manager of engineering for the Rectifier Department has been announced by *General Electric Company* . . . **NILES P. GOWELL** has been named chief engineer of the *Raytheon* receiving tube division. He has been with the firm since 1928 . . . **ANTHONY DIL- LON** has been promoted to the newly-established post of manager of market development for *CBS-Columbia*. He has been with the company since 1950 and will make his headquarters at the firm's Long Island City plant . . . **BRUCE L. MacPHERSON** has been named western divisional sales manager for *Reeves Soundcraft Corp.* He will be located at the company's new West Coast office at 338 N. LaBrea, Los Angeles . . . *Telrex, Inc.* has named **CHARLES T. GABRIELE** to the post of advertising and public relations manager. He was formerly with *Thomas A. Edison, Inc.* . . . **WILLIAM C. OTTO** has been named industrial sales manager of the Indianapolis Division of *Cornell-Dubilier Electric Corporation*. He was formerly chief engineer of the division . . . **THOMAS P. WALKER** has

been elected chairman of the Los Angeles Council of the West Coast Electronic Manufacturers Association for 1956. He is vice-president of *Triad Transformer Corporation* of Venice, California . . . **GEORGE H. IMMEN** has been named applications engineer at *Clarostat Mfg. Co., Inc.* He will work out of the firm's main office in Dover, N. H. . . . **STANLEY F. PATTEN** has been elected treasurer of *Allen B. Du Mont Laboratories, Inc.* in addition to his duties as vice-president and director of the firm. Before joining the company he served the U. S. Navy, retiring with the rank of Rear Admiral.

* * *

GEORGE I. BACK who retired as Chief Signal Officer of the United States Army after 38 years of service has been appointed assistant to the president of *International Resistance Co.* of Philadelphia.



In his new assignment General Back will investigate new markets for products and processes developed by the company's research department. In addition to holding numerous decorations and commendations from U. S. and foreign governments, General Back was the first Signal Corps Officer on active duty to receive the Fellow Award in the forty-two year history of the Institute of Radio Engineers.

-30-

Kuba

Europe's largest manufacturers of Radio and TV Combination Consoles

are now extending their coverage to the US-markets. We're looking for alert, experienced radio and TV sales organizations who want to take advantage of this tremendous development . . . selling in America our companion line of highly styled radio-phonograph and TV cabinets in traditional, contemporary and modern design. The complete KUBA quality line will be nationally advertised.

Qualified organizations are invited to give full details, state lines carried, and territory covered.

Kuba

TONMOEBEL UND APPARATE-BAU
 15 Lindenerstr. Wolfenbuettel, Germany

Servicing Changers
(Continued from page 61)

the rocker arm. In the case of the spindle-type drop, the pusher shaft, located inside the spindle, actuates the record pusher and is connected to the drive gear by a record drop link. Such a mechanism is shown in Fig. 3 where the link consists of the cycling slide and the lift arm. When determining the drop mechanism, ignore the other parts as they are momentarily unimportant.

Other portions of the mechanism may be similarly located. Think of the record changer in sections based on the changer action.

In changing records, the trip mechanism is first actuated, then the record is dropped, and finally, the pickup sets down to start playing the next record. The trip mechanism may operate in several ways, but is always simple in nature. When the record player is first turned on, the control knob is turned to *reject*, causing the trip mechanism to operate. Thereafter, the motion of the pickup arm in the finishing groove of the record is used to actuate the trip. Hence, the manually-operated trip may be used to further study the trip mechanism and isolate the trouble. Fig. 6 shows one particular trip mechanism.

The motion of the trip mechanism may be studied by moving the control knob so the trip is actuated. This may be repeated as many times as necessary to follow the linking pieces from the control knob to the clutch pawl. The clutch pawl is the movable tie between the drive gear and the hub gear on the turntable. In Fig. 6, the linking pieces consist of the control link, the manual reject lever, the trip slide, and the lower and upper trip pawls.

When the manually-operated portion of the trip mechanism has been determined, look for the pickup-arm lever

Fig. 6. Two facets of a typical trip mechanism are shown here: (A) during automatic action, and (B) on manual.

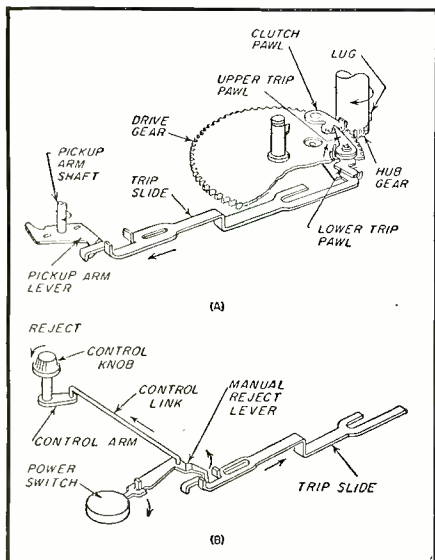

MAKE MORE MONEY ON SERVICE!

TELEVISION • RADIO • ELECTRONIC

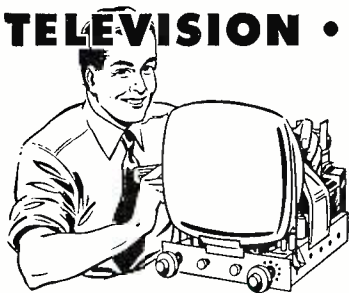

Learn to handle ANY job easier, better and lots FASTER this modern professional way!

ONLY \$12 FOR THE COMPLETE TRAINING *You Save \$1.25*

THESE two big, fact-packed Ghirardi training books make it easy for you to become expert on all types of home radio and television receiver service—at absolute minimum cost!

Ask the men who already have good-pay jobs! They'll tell you that Ghirardi training is the finest—AT ANY PRICE—because it is so outstandingly complete, and because it makes even the

toughest subjects so easy to understand.

Each of these two books is entirely new, completely modern in every respect—NOT a re-hash of old, outmoded material. Together, they form a complete service library written so you can easily understand every word—and designed to serve either as a complete training course or as a handy reference for experienced servicemen who want to look up puzzling jobs or develop new and faster methods.

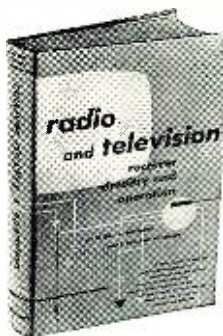

Radio and Television Receiver CIRCUITRY AND OPERATION
By Ghirardi and Johnson
669 pages, 417 helpful illustrations

Learn all about Circuits... AND WATCH SERVICE "HEADACHES" DISAPPEAR

Years of experience plus hundreds of talks with service technicians proved to Mr. Ghirardi the need for a book that got right down to earth in explaining the basic circuits and operations of modern radio and television receivers. Radio & Television Receiver Circuitry and Operation is the result. Backed by what you can learn from it, you'll find that 9 out of 10 service jobs are tremendously simplified. You'll work faster with less testing—and make more money in the bargain! Guesswork is eliminated.

Starting with AM and FM processes and characteristics, the book

progresses to a complete understanding of basic circuits, how they operate, how to recognize them quickly and what is likely to go wrong with them. By making it easy for you to understand each circuit and its relation to other circuits, the book helps you go right to the seat of trouble in far less time. You'll know what different trouble symptoms mean—and you'll know how to repair troubles lots faster and more efficiently.

Sold separately for \$6.50. Try it for 10 days on our FREE examination offer.

Complete Training in MODERN, PROFESSIONAL SERVICE METHODS

This big book makes the tough service jobs easy, makes the easy ones a cinch!

Actually, Radio & Television Receiver TROUBLESHOOTING AND REPAIR is a complete guide to modern professional service methods.

First you get a full analysis of components, their functions, their troubles and their remedies. Next you learn modern troubleshooting methods—from "static" tests to dynamic signal tracing and injection techniques. You learn basic procedures and how to interpret performance data. Four big chapters show how to realign Television, FM and AM receivers in less time. You'll learn how a glance at a TV set may quickly tell you what is wrong. Special hard-to-fix service problems are explained. Puzzling "intermittent" troubles and their remedies are clearly outlined. Step-by-step service procedure charts demonstrate many operations almost at

a glance. In short, from the simplest troubles to the most difficult ones, nothing has been omitted—nothing has been condensed. Everything is carefully explained—and the entire book is fully indexed so you can find exactly what you want in a jiffy.

Read it 10 days FREE! See for yourself how this great book can pave your way for bigger pay. Sold separately for \$6.75. Save money by ordering special combination offer.



Radio and Television Receiver TROUBLESHOOTING AND REPAIR
By Ghirardi and Johnson
822 pages, 417 clear illustrations

SPECIAL money-saving OFFER!

Save \$1.25 by ordering both of the above big books. Make your service library complete!

Dept. RN-36, RINEHART & COMPANY, Inc.
232 Madison Ave., New York 16, N. Y.
Send books below for 10-day FREE EXAMINATION. In 10 days, I will either remit price as indicated (plus a few cents postage) or return books postpaid and owe you nothing.

- Check here to order books singly:
- Radio & TV Receiver CIRCUITRY & OPERATION (Price \$6.50 separately)
 - Radio & TV Receiver TROUBLESHOOTING & REPAIR (Price \$6.75 separately)
 - Check here for MONEY SAVING COMBINATION... Save \$1.25! Both of the above big books at the special price of only \$12.00 for the two. (Regular price \$13.25—you save \$1.25.) Payable at the rate of \$3 after 10 days if you decide to keep books and \$3 a month thereafter until the total of \$12 has been paid.

Name
Address
City, Zone, State, \$7.25 for TROUBLESHOOTING & REPAIR book; \$7.00 for CIRCUITRY & OPERATION; \$13.00 for both books. Cash with order only. Money refunded if you return books in 10 days.

RINEHART BOOKS ARE SOLD BY LEADING BOOK STORES

from **HARVEY**
the House of Audio

New **DYNAKIT**



Mark II
**50-Watt
Amplifier
KIT**

At last—a no-compromise high-power 'dream' amplifier in easy-to-build kit form at a popular price! A new circuit of unusual simplicity and stability, a newly developed output transformer, plus streamlined physical design employing a fully wired printed circuit board result in performance second to none and high consistency from unit to unit.

Rated power output, 50 watts (continuous); intermodulation distortion, less than 1% at rated power; harmonic distortion, less than 1%, 20-20,000 cps within 1 db of rated power; frequency response, ± 5 db 6-60,000 cps and ± 1 db 20-20,000 cps; square wave response essentially undistorted; 20-20,000 cps; 6CA7/EL-34 push-pull output; output impedance, 8 or 16 ohms

Complete with all parts and tubes,
plus instructions

\$6975

Visit **HARVEY's** new
AUDIOTORIUM

an entire building devoted
exclusively to high fidelity

C. G. McProud's
Printed-Circuit, Miniaturized
'Preamp with Presence' KIT

Described in the May, 1955, issue of Audio, this highly versatile, up-to-date, low-noise, low-distortion preamplifier has every desirable feature—phono equalization control, volume and loudness controls, Baxendall-circuit bass and treble controls, plus a unique 'presence' control

Basic Kit (1.0-henry encapsulated choke, completely drilled printed circuit panel, plus complete metal chassis) **\$750**

Complete Kit (all parts as specified, including the basic kit, plus instructions) **\$3550**

New
MICRO
Floating Drive
TURNTABLE



Built to professional standards, the new MICRO turntable unit features a unique and ingenious floating drive system which provides complete acoustical and mechanical decoupling between motor, base and turntable for flawlessly smooth and silent performance. The exclusive MICRO shift makes possible instant selection of any of 3 speeds while the turntable is operating, without damage to the drive mechanism.

Complete **\$5950**

AUDAX
Hi-Q7 'Chromatic'
Magnetic Pickup
CARTRIDGE



Widely admired for its natural sound, the Hi-Q7 features extremely high lateral and vertical compliance, 20-15,000 cps frequency response, an ingenious turnover arrangement with two individually replaceable styli in a single head, and superb overall listening quality. It comes with one near-infinite-compliance "Chromatic" diamond micro-groove stylus and one micro or standard-groove sapphire stylus.

Complete **\$4770**

Established 1927
HARVEY RADIO CO., INC.
1123 Ave. of the Americas (6th Ave.)
103 West 43rd St., New York 36, N. Y.
JUdson 2-1500

which is located below the baseboard and is connected directly to the pickup-arm shaft. As the pickup arm moves toward the spindle, determine where the pickup-arm lever will contact the trip link. In this case, the pickup-arm lever contacts the trip slide. Remember that both the control knob and the pickup-arm lever always operate the same clutch pawl.

The indexing mechanism controls the set-down of the pickup arm in the starting groove of the record. If the needle sets down at the wrong point, locate the fine indexing adjustment. This is frequently contained in the pickup arm and is accessible through a hole in the top, as shown in Fig. 7A. If the adjustment is not located in the pickup arm, look for it on the baseplate between the pickup arm and the turntable. Try turning it slightly and observe the results. Adjust until proper indexing is obtained.

If the fine indexing adjustment does not have enough range, locate the coarse indexing adjustment, usually directly associated with the pickup-arm shaft or pickup-arm return lever (see Fig. 7B). Before making the coarse set-down adjustment, the fine adjustment should be put to the midpoint of its range. After making the coarse adjustment, the fine adjustment can be readily set so the needle lands properly at the beginning of the record.

If the pickup arm skates across the record or skips grooves, it is likely that the trouble is in the indexing mechanism or the pickup arm. If pickup-arm friction measurements did not show any difficulty, check to see if the turntable is level. A small level can be used to check the turntable in two directions at right angles to each other. If the turntable is level, then investigate the indexing mechanism. Usually the same mechanism that lifts the pickup arm from the record allows the pickup arm to come back down again. This vertical lift mechanism, as it is called, can be traced by finding the link between the pickup-arm lift rod and the drive gear. This does not often require adjustment, but if it does, take

care not to move the set-down adjustment to do so. In the mechanism of Fig. 7B, the pickup-arm shaft and lift rod are combined. The link consists of the cycling cam, the pickup-arm raising lever, and the pickup-arm raising disc. To adjust the vertical lift, bend the pickup-arm raising lever. Do not adjust the pickup-arm raising disc. Most record changers have a screw to adjust the vertical lift.

Repairs

Normal wear in a record changer does not usually affect metal parts. On the other hand, most record changer troubles are due to either defective springs or else bent or warped metallic parts caused by jamming or other types of excess pressure. When an equipment jams, look to see where the trouble exists. To free a jammed mechanism, rotate the turntable by hand in a counterclockwise direction.

If a part is bent, it must be straightened. Duckbill pliers with smooth jaws should be used so the part is not marked. Thin metallic parts may be readily straightened; parts with heavier stock may require the use of two pairs of pliers, one grasping the piece on each side of the bend.

Burrs on mating parts give excess friction and must be removed by filing. If the part is thin metal, support it with a pair of duckbill pliers so that it will not bend. Clean off the filings and polish the edge with crocus cloth. Then follow with a cleaning with carbon tetrachloride, taking care not to breathe the fumes as they are dangerous. Where required, lubrication may be applied.

Binding of a pivoted part is often caused by accumulation of dirt and foreign particles. Clean by liberally applying carbon tetrachloride. If this does not suffice, remove the part and clean the bearing surfaces. Binding may also be caused by a part being bent near the pivot, squeezing the shaft.

A variety of springs are used in record changers. The usual use of a spring is to actuate a part when it is released, or to return a part to its rest

Fig. 7. Shown here are the locations of the fine and coarse indexing adjustments of the pickup arm used in one particular record changer. The indexing adjustment determines where on a record the pickup arm will set down to start the playing.

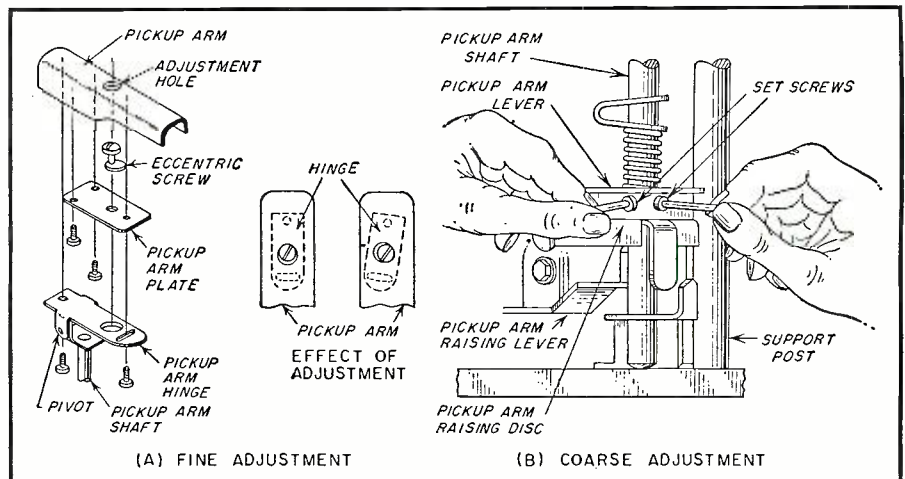

position after actuation has been completed. Spring tension may be checked by moving the part engaged by the spring with your finger. Check to see if the part moves freely and still returns properly. If not, remove the spring and move the part to see if the trouble is a binding condition. If it is the spring that is at fault, replace it. Adjustment of springs is not always easy and frequently is not effective because the trouble will repeat. A fatigued spring will soon lose its tension even though adjusted.

If the exact replacement spring is not available, try several to see which works best. Experience will soon allow you to get the feel of those you try so the number checked can be kept to a minimum. If the spring is too strong, the mechanism may be overloaded. This can cause as much trouble as failure to actuate because the spring is too weak. Be sure to check the operation several times after replacing a spring to make sure it works properly.

One problem often encountered is a rhythmical thumping sound as the turntable rotates. This is caused by a notch or flat in the rubber rim of the idler wheel. To correct it the idler wheel must be replaced. The notch or flat can be caused by prolonged pressure between the motor shaft and the idler. If so, replacement is sufficient. It can also be caused by jamming of the changer keeping the turntable from rotating. Under this circumstance the idler wheel stands still, but the motor may keep running, wearing a piece out of the rubber on the idler wheel. The cause of jamming must be corrected before the idler wheel is replaced.

Lubrication is important in proper operation of a record changer, especially since overlubrication is even worse than insufficient lubrication. Inspect rubber pieces closely to make sure that oil and grease do not get on them. Oil deteriorates rubber. Clean off such pieces with alcohol. Do not use carbon tetrachloride as it is sometimes a solvent for the rubber.

In other instances carbon tetrachloride is a good cleaning agent. Oil and grease collect lint, dirt, and foreign particles. Hence, cleaning is often required. Then lubricate with care. Only rubbing surfaces should be lubricated. Pawls, particularly of the gravity type, usually do not require lubrication. Lubrication must not be used on friction-operated pieces such as used in velocity-trip mechanisms.

Where heavy pieces of metal mesh, a light grease such as "Lubriplate" or "Sta-Put" should be used. For lighter pieces, a good quality machine oil, such as S.A.E. 10W (available at your gasoline service station) is proper. Do not use "3-in-1" oil, and do not be generous with the lubricant. A little goes a long way.

The author would like to thank the McGraw-Hill Book Company, Inc., for permission to use some of the diagrams which originally appeared in his book, "Repairing Record Changers," (Copyright 1955).

-30-



90 SECONDS
THAT CAN
CHANGE YOUR LIFE!
put you on the road to big pay, a lifetime career in

Take 90 seconds now to fill out and mail coupon below ... open the door to a real career in the fabulous, fast-growing field with a future: **Television-Radio-ColorTV!**



BIG OPPORTUNITY NOW WITH COLOR TV BOOM. 37 million TV sets in America today. Add over 1,000 color sets being sold every week. More and more trained men with service and repair skills are needed every day. Television offers you the chance of a lifetime. Coyne's low-cost, home training prepares you *NOW* for a fascinating and prosperous future—a good job or independence in your own business.

COYNE QUALITY HOME TRAINING at unbelievably low cost—you pay for training only—no costly "put together kits." Not an old Radio Course with Television "tacked on." Here is MODERN TELEVISION TRAINING including Radio, UHF, VHF and COLOR TV. No radio background or previous experience needed.

You study simple, easy to follow, step-by-step instructions fully illustrated. *Practical job guides* show you how to do actual servicing jobs right from the start.

B. W. COOKE, Pres. Founded 1899

COYNE
ELECTRICAL SCHOOL

A TECHNICAL TRADE INSTITUTE
OPERATED NOT FOR PROFIT

500 S. Paulina St., Chicago 12, Dept. 36-HT5

EARN TUITION WHILE YOU LEARN. Keep present job—learn at home—earn extra cash repairing neighbors' radios and TV sets during spare moments *while training.*

Send Coupon for Free Book



and full details, including Easy Payment Plan. No obligation, no salesman will call.

COYNE Television Home Training Division
500 S. Paulina St., Chicago 12
Dept. 36-HT5

Send Free Book and details on how I can get Coyne Quality Television Home Training at low cost and easy terms.

Name _____

Address _____

City _____ State _____

TAPE RECORDERS

Tapes—Accessories
Nationally Advertised Brands
UNUSUAL VALUES
Send for Free Catalog
DRESSNER
Box 66RA, Peter Stuyvesant Sta.,
New York 9, N. Y.

MERITAPE
Low Cost, High
Quality Re-
cording Tape—
in boxes or
cans.

NEW JENSEN MANUAL TELLS HOW TO BUILD YOUR OWN HI-FI SPEAKER SYSTEMS
Save money... have fun building your own Jensen 2-way or 3-way hi-fi speaker system. New 36-page manual tells how to make enclosures and assemble 18 different systems with 8 new Jensen speaker kits. Send 50c today for Jensen Manual 1060.
JENSEN MFG. CO. Dept. J, 6601 S. Laramie, Chicago 38

NOW IN STOCK of NIDISCO

EICO NEW

COLOR & MONOCHROME
Laboratory &
TV SERVICE 5-MC SCOPE

713 Newark Av., Jersey City, N. J.
55 State St., Hackensack, N. J.
204 Passaic St., Passaic, N. J.
658 Amerson Av., Cliffside, N. J.
128 S. Warren St., Trenton, N. J.



#460
KIT \$79.95
Factory Wired \$129.50

NO COUPONS! NO BONUSES EXCEPT THE

LOWEST PRICES

Take your pick!
Any Assortment!

TUBES

41c

ea.

Quantity Buyers!
100 Tubes — \$38.00

All Tubes Unconditionally Guaranteed
For 1 Year

PRETESTED TUBES			INDIVIDUALLY BOXED		
0Z4	6AC7	6BK5	6SK7GT	12AL5	12SQ7
1B3GT	6AG5	6BK7	6SL7GT	12AT7	12SR7
1H5GT	6AG7	6BL7GT	6SN7GT	12AU6	19BG6G
1LC5	6AF4	6B06GT	6SQ7	12A07	25BQ6GT
1LN5	6AK5	6B07	6SR7	12AV6	25L6GT
1N5GT	6AL5	6BY5G	6T8	12AV7	25W4GT
1Q5GT	6AQ5	6BZ7	6U8	12AX4GT	25Z5
1R5	6AS5	6C4	6V3	12AX7	25Z6GT
1S4	6AT6	6CB6	6V6GT	12BA6	35B5
1S5	6AU6	6CD6G	6W4GT	12BE6	35C5
1T4	6AU5GT	6F6	6WG6T	12A27	35L6GT
1TSGT	6AV5	6H6GT	6X4	12B7	35W4
1U4	6AV6	6J5GT	6X5GT	12BY7	35Y4
1X2	6AX4GT	6J6	6Y6G	12SA7	35Z5GT
3Q4	6AX5GT	6K6GT	7C5	12SG7	50A5
3S4	6AH4GT	6L6	7C6	12SJ7GT	50B5
3V4	6BA6	6S4	7C6	12SK7	50C5
5U4G	6BC5	6S8GT	7E7	12SL7GT	50L6GT
5V4G	6BE6	6SA7	7F7	12SN7GT	117Z3
5Y3	6BG6G	6SH7	7F8		
6AB4	6BJ6	6SJ7GT	7N7		

BRAND NEW PICTURE TUBES

RCA and DUMONT Licensed

10BP4A	11.95	16GP4	20.99	17LP4	18.00	21ALP4A	24.00
12LP4	14.99	16RP4	18.00	19AP4A	23.00	21EP4A	24.00
14BP4	15.99	17BP4A	19.00	19DP4A	23.00	21AUP4A	24.00
16AP4A	19.99	17HP4	19.00	20CP4	24.00	21FP4	24.00

Picture Tubes Shipped F.O.B. Passaic, N. J.
PRescott 3-0330

TUBE MART

DISCOUNT HOUSE

The Lokpet Bldg. Passaic, N. J.

FREE POSTAGE on all prepaid U. S. A. orders. 25c handling charge on all orders under \$50.00. 25% Deposit on all C.O.D.'s. Subject to prior sale. Write for FREE TUBE LIST!

test and rejuvenate your CRT's with the



An unbeatable combination . . . a CRT tester and rejuvenator in one small, compact, featherweight, low-cost unit. Simple to operate with one-knob control, a large, easy-to-read 4½-inch meter and a neon tube short indicator. And it weighs less than 4 pounds!

Cut operating costs by saving time and money on trade-in reconditioning and on-call CRT vitalizing. Restore normal CRT performance in 90% of cases!

TESTING

- checks cathode beam current
- locates hot and cold inter-element shorts
- checks resistance leakages as high as 5 megohms
- checks gas content and loss of brightness

REJUVENATING

- removes contamination from cathode surface
- corrects gassy (soft) picture tubes
- restores and improves emission quality
- Cathode activity is constantly metered during the rejuvenation process, thereby preventing permanent tube damage

TELETEST
INSTRUMENT CORP.

See your local jobber, or write TODAY:

31-01 Linden Place, Dept. N-3, Flushing 54, N. Y.



Model RT-203

1-YEAR FACTORY SERVICE GUARANTEE

only \$49⁹⁵

Servicing Your V.T.V.M.

(Continued from page 68)

manufacture, in most cases) may have lodged itself between the coil and the magnet of the movement. The pivots by means of which the movement coil is seated in its bearings may not be properly positioned.

The repair of such troubles should be undertaken in a clean work area with as little dust as possible. To straighten a bent pointer, two toothpicks may be used. Hold one toothpick against the scale, next to the bend in the pointer, so that it will act as a fulcrum (see Fig. 6). Gradually bend the pointer back into place by pushing with the other toothpick near the outer end of the pointer. Don't blow into the movement. Don't get rattled, don't rush. Don't have both toothpicks in the air at the same time. Always keep the first toothpick in place against the bend in the pointer.

To remove a metallic particle, a toothpick, or nonmagnetic (aluminum) tweezers or screwdriver may be used. If the pointer must be pushed out of the way to permit easier access to the particle, move it to the center of the scale with the toothpick. It may be kept in this position simply by resting the toothpick gently against the scale.

To re-seat the coil pivots in their bearings, loosen the locknut that keeps them tightly in place, re-position the pivots, and re-tighten the locknut. (The locknut referred to is the one used under the zero adjustment screw on the panel of the meter.) Make sure that the coil assembly is able to move freely. The vertical play should be made as small as possible, without introducing binding. Do not loosen the locknut too much, otherwise the fixed support provided for the hair spring may change in position. When the locknut is to be tightened, hold the adjustment screw in position with a screwdriver.

The v.t.v.m. is inoperative or inaccurate on one range. This kind of trouble is almost always the result of improper use of the meter (measurement of a relatively high voltage on a low-range setting). A burnt (off-value) resistor is usually the cause of the symptoms. In some cases, inaccurate readings on more than one range will be noted. Visual inspection will usually locate the defective part. It pays in these instances to check other resistors in the section affected, to make sure that their values have not been altered by heat. —50—

Fig. 6. Straightening a bent needle.

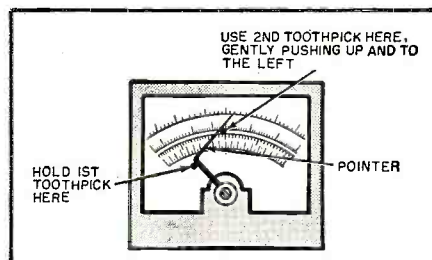

New . . . Test Equipment for Servicing

"THE CAPACITEST"

The Barjay Co., 145 W. 40th Street, New York 18, New York is currently marketing a new piece of test equip-

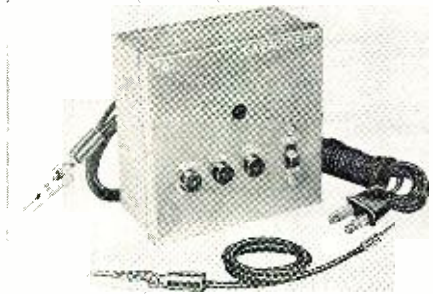

ment that is designed to save the technician both time and money.

Known as the "Capacitest," this unit will show open, shorted, or intermittent capacitors and detect leaky electrolytics. In addition, it will show circuit continuity and a.c. and d.c. voltages. It will indicate leakage of over 300 megohms.

The instrument tests capacitors at 150 volts which is approximately their working voltage in a radio or TV set. The entire unit measures a mere 4" x 4" x 2" and is designed to be carried in a tool kit.

"TELE-CHECK"

Telematic Industries, Inc., 16 Howard Ave., Brooklyn, New York is now in production on a portable test picture tube and yoke assembly which enables the technician to make quick, positive checks without removing parts from the set.

The "Tele-Check" consists of an all-purpose 5AXP4 CRT tube, a universal yoke, and 6-foot extension leads for extending CRT socket, anode, and yoke connections. It is housed in a light-



weight leatherette case. It can be used for both bench applications, and on house calls.

March, 1956



"TAPE RECORDERS How They Work"

by Charles G. Westcott

◀ This is the book for everyone interested in Tape Recording

Now you can have an expert understanding of tape recording. Explains magnetic recording theory; describes characteristics of tape. Tells how a recorder operates; discusses motorboard mechanism, drive motors, volume indicators, bias oscillators, equalization circuits, amplifiers and magnetic heads—includes diagrams, photographs and schematics. Tells you how to get best frequency response with lowest noise, how to avoid tape overload, how to obtain best bias settings; includes procedures for testing tape recorders and tape. The comprehensive book about Tape Recorders. 176 pages; 5½ x 8½"; over 150 illustrations. Postpaid, only \$2.75

USE HANDY ORDER FORM BELOW

All the Facts About
TAPE RECORDING

only \$2.75

ORDER TODAY

SAMS BOOKS
keep you ahead in
ELECTRONICS

Sams books cover every phase of Electronics for the service technician, engineer, student or experimenter. Listed below are a few of the many valuable Sams books available at electronic parts distributors and leading book stores.

USE THIS ORDER FORM

**TAPE RECORDERS—
HOW THEY WORK \$2.75**

Transistors—Their Application in Television Radio-Electronics. The first practical, complete book on transistors; explains circuitry, installation, testing techniques, theory and servicing. 100 pages; 5½ x 8½" illustrated. \$1.50

Fundamentals of Color Television. An up-to-date explanation of Color TV, its theory, operation, installation and servicing, with photos, block diagrams and schematics. 224 pages; 5½ x 8½"; illustrated. \$2.00

Servicing TV Sweep Systems. Describes the operation, circuit function and circuit variation of vertical and horizontal sweep systems common to most TV receivers. Tells how to analyze circuits; trouble-shoots for you. 212 pages; 5½ x 8½"; illustrated. \$2.75

Technical Dictionary. Over 4,000 definitions of radio, television, electronic, electrical and radar terms. Includes valuable charts, graphs, diagrams and symbols. Flexible binding for "on-the-job" use. 160 pages; 5½ x 8½". \$2.00

TV Test Instruments. Tells how each instrument operates, how to use it in actual servicing. Covers Vacuum Tube VM's, AM Signal Generators, Sweep Signal Generators, Scopes, Video Signal Generators, Field Intensity Meters and Voltage Calibrators. 180 pages; 8½ x 11" \$3.00

The Recording and Reproduction of Sound. The largest selling book in its field. Widely used by Audio engineers, Hi-Fi enthusiasts, P.A. technicians, broadcasting stations and recording studios. Authoritative chapters cover: behavior of sound waves; basic recording methods; lateral disc recording; micro-groove recording; the decibel; phono reproducers; cutting styli; microphones; loud speakers and enclosures; home music systems; public address systems; amplifiers; tuners, etc. 810 pages, 6 x 9"; illustrated \$7.95

Atomic Radiation, Detection and Measurement. Provides a basic understanding of nuclear science and its applications. Includes a full discussion of equipment and techniques required for detecting and measuring radiation. The service technician will be particularly interested in chapters dealing with the circuitry and operation of the many types of detection devices. 200 pages; 5½ x 8½" \$3.00

Audio Amplifier Service Manuals

Vol. 6. Schematic diagrams, illustrations, parts lists and invaluable servicing data on 36 amplifiers, 18 preamps and 13 tuners produced in 1953-54. All data is based on analysis of the actual equipment. 352 pages, 8½ x 11" \$3.95

Vol. 5. Covers 37 amplifiers, 12 preamps, 14 tuners, 1952-53. 352 pages. \$3.95

Vol. 4. Covers 75 amplifiers and tuners produced in 1951-52. 352 pages. \$3.95

Vol. 3. Covers 50 amplifiers and 22 tuners produced in 1950. 352 pages. \$3.95

Record Changer Service Manuals

Vol. 6. Includes diagrams, photos, exclusive "exploded" views, parts lists and service data for 20 popular record changers and recorders produced during 1953-54. All data based on lab analysis of the actual equipment. 288 pages, 8½ x 11" \$3.00

Vol. 5. 32 models; 1952-53; 288 pages \$3.00

Vol. 4. 38 models; 1950-51; 288 pages \$3.00

Vol. 3. 44 models; 1949-50; 288 pages \$3.00

Vol. 2. 45 models; 1948-49; 432 pages \$4.95

There is an authoritative Sams book on virtually any Electronic subject in which you're interested. Check below for FREE Book List describing all Sams books.

Send Book List



Look for
SAMS BOOKS
on the
"Book Tree"
at your Parts
Distributor

HOWARD W. SAMS & CO., INC.

Order from your Parts Jobber today, or mail to Howard W. Sams & Co., Inc., Dept. 1-C6, 2201 East 46th St., Indianapolis 5, Indiana.

Send books checked above. My (check) (money order) for \$ is enclosed.

Name

Address

City Zone State

(outside U.S.A. priced slightly higher)

COMMAND ARC-5 TRANSMITTER BC-458



Brand New.... \$495
7 to 9.1 mc.....\$5.95

Command Equipment (274N-ARC5, ATA)

Model RECEIVERS	Less Tubes As is	Excellent Used	Brand New
520-1500 KC ...		\$14.95	\$19.95
1.5-3.0 MC ...		9.95	14.95
3-6 MC ...	\$2.95	4.95	
6-9 MC ...	2.95	3.95	
100 MC-156 MC ...		9.95	
TRANSMITTERS			
2.1-3 MC ...		9.95	
3-4 MC ...		6.95	
4-5.3 MC ...		3.95	5.95
5.3-7 MC ...		3.95	4.95
7-9.1 MC ...		3.95	5.95
100-156 MC ...		13.95	
BC 456 Modulator		2.95	4.95
MD 7 Modulator.			7.95

LORAN EQUIPMENT

Marine or Airborne Long Range Navigational equipment! Determine the exact geographic position of your boat or airplane!
AN/APN4 Loran set. Frequency range 1700-2000 KC. complete with ID6B/APN4 indicator, R9B/APN4 receiver, crystal and plugs. **\$129.50**
Complete. Brand New
AN/APN-9 Brand New. **\$295.00**
(Quantity prices available—write)
R-24/ARC5—Broadcast Receiver—520 to 1500 KC. broadcast band. 6 tubes: 3-12SK, 12A6, 12X8, for dynamotor operation. Easily converted to 110 volt or 32 volt use. Two IF stages, 3-gang tuning cond. Brand new in sealed carton with tubes and instruction manual, less dynamotor. **\$14.95**
Exc. **\$19.95**
New

MN-26-C Remote Controlled Navigational Direction finder and communications receiver. Manual DF in any one of three freq. bands, 150 to 1500 KC. 24V. Self contained dynamotor supply. Complete installation, including receiver, control box, loop, azimuth control. Left-Right Indicator, plugs, loop transmission line and flex. shafts, oper. & main manual. Ideal for use in boats, etc. **\$39.50**
BRAND NEW
MN-26-E Loop. Brand New. **4.95**
MN-52 Crank Drive. New. **2.50**
MN-26-C as is for parts. **6.95**
MN-26-C Rcvr., New. **12.95**
MN-28-C Control Box for above. **6.95**
New

\$4500 HI-FI Headset for only \$4.95

Uses annular grooved plastic fiber cones with voice coils as in speakers and padded chamois earmuffs to obtain spacing for correct acoustical lead.
Gives finest music reproduction. 600 ohms. Checked out.
Exc. w/earpads.....each **4.95**

RT-24/APX-2 IFF EQUIPMENT. 44 tube transceiver with usable parts, tube sockets, relays, coax fittings, condensers, resistors, etc. 24 volt Blower motor, 24V rear train motor. Power transformer 400 to 2400 cycles.
Original govt. cost \$750.00.
Complete with tubes.....ea. **\$14.95**

3" dual scale panel-meter. 0-1 MA movement calibrated. 0-1 KV and 0-10 MA.
Used—**\$1.95 ea.** New—**\$2.95 ea.**

A Sweet Oscilloscope Deal

INDICATOR UNIT. For conversion to test scope, panadapter, analyzer, etc. Double deck chassis. 5CP1 mounted in tube shield. Less small tubes and crystal, but complete with 5CP1. **\$9.95**
Exc. cond.....each

EES—ARMY FIELD PHONES.
Brand Newea. **\$29.50**

Freq. Meter—Cavity tuned—absorption type—110 VAC 60 cycle 150 to 240 Mc.
Like Newea. **\$24.50**

REMOTE CONTROLS for your xmit rig. Complete with mike, head-set amplifier-selector unit, 100 ft. of 2-cond. cable—Spare parts and trunk. Newea. **\$69.50**

BC442—Antenna

Relay Unit complete with 50 MMF 5 AMP CONDENSER. Newea. **\$3.95**
Less Condenserea. **\$1.95**

MP-28 modulation & power supply for the TA-12 transmitter. Complete with 4 tubes. Dynamotor has an output of 540 V. DC at 450 ma. Input at 28 V. DC. **\$14.95**
With dynamotorea. **\$5.45**

HS-33 600 Ohm—New.ea. **\$5.45**

HS-23 Hi-Imp headphones—Used, exc. ea. **\$2.95**
TS-F1 Handset—Excellent Model.ea. **\$2.49**
TS-9 Handset—Complete with cord & Butterfly switch. Brand New Original Cartons.ea. **\$6.00**

10 forea. **\$60.00**
T-26 Mobile Chest Mike. Brand new.ea. **\$1.29**
TU26—Excellentea. **\$1.95**

BC-375 XMITERS

200 to 500 KC. 1500 to 12500 KC., using plug-in units. 100 Watts. Voice and C.W. Complete with tubes. Less tuning unit. Used, exc. cond.ea. **\$14.95**

12 V. DC DYNAMOTOR For Ham-mobile, Mobile X'mitrs., Etc. Output 625 V. DC at 225 ma. These Dynamotors are NEW—UNUSED, Shr. Corp. Type DM-33, and ruggedly designed for long service. Ideally suited for application in portable or mobile transmitters, sound systems, etc. Incorporates mtr. plate and Jones connectors. Dim.: 8" long x 4 1/2" deep x 4" high. Shpg. wt. 17 lbs. PRICED REAL LOW for New MaterialNew **\$12.45**
Used **8.45**
SAME DYNO AS ABOVE EXCEPT 28V DC Input. **4.95**

BC 906 Cavity type freq. meter. 144 Mc to 235 Mc. Complete with antenna and operating manual. Brand new—Orig. factory pack.ea. **\$14.95**

SURPRISE PACKAGE

20 lbs. of MISCELLANEOUS ELECTRONIC EQUIPMENT—WORTH MUCH MORE than this low price of **ONLY \$1.95**

RG-8/U—COAXIAL CABLE—52 ohms, 50 ft. length with connectors, each end.....ea. **\$2.95**
BC-906-1H

OIL FILLED CAPACITORS

All from 600 to 1000 volts. 2 mfd at 1000 VDC. 4 mfd at 600 VDC. 4 mfd at 600 VDC. 8 mfd at 600 VDC. 12 mfd at 600 VDC. 20 mfd at 600 VDC, plus others. **\$5.95**
10 for

LEEDS NORTHRUP

Variable self inductance coil, 55 to 460 MH P/M 10MH. Brand Newea. **\$24.95**

DYNAMOTORS

Type	Input	Output	Used	New
DM-83	12 VDC	375-450 MA.	\$1.95	\$4.25
DM-35	12 VDC	625 VDC 225 MA	9.95	12.95
DM-37	24 VDC	625 VDC 225 MA	6.95	9.95
DM-64	12 VDC	275 VDC 150 MA	3.95	5.95
DM-34	12 VDC	220V 80 MA.	2.95	4.95

MOBILE HEAVY DUTY DYNAMOTOR: 14 V. INPUT-output: 1030 VDC 260 MA. Tapped 515 V. 215 MA. use or 6 V DC INPUT-500 V. 175 MA. While they last—DM-42-Excel. Condition. **\$4.95**
Brand Newea. **\$9.95**

METER—3"-0-5 Ma. 270° Indication—By Pass Shunt and add scale. Excellent Condition. **.95c**
6 forea. **\$5.00**

BRAND NEW

10 tubes for \$2.50

Includes, 316A, 211, 801, 6C4, 6SK7GT, 954, 955, 957, 900B, 6SH7, 1629, 1625, 1626.
5CP1 3BP1 { **\$2.95 ea.**
5BP1 3CP1 { **4 for \$10.00**
5AP1

LARGE CHAMOIS EAR CUSHIONS

For your headphones—brand newea. **\$1.49**

APG 5 or 15 CAVITY

10 Cm. 2C43 osc Xmitter, 2C40 Loc. Osc. Rec. 1B27 TR; tunes 2400 to 3000 MCS, less tubes. Priceea. **\$4.95**

BEACON RECEIVER BC-1206-C

Complete with 5 tubes. Tunes 195 KC to 420 KC. IF Frequency—135 KC. Receiver Sensitivity—3 Microvolts for 10 Milliwatts output. Output Impedance—300 Ohms and 4,000 Ohms. Volume Control—RF Gain Control. Power Supply—24-28 Volts Aeroplane Battery. Current—75 Amperes. **\$9.95**
BRAND NEW, with Tubes.....ea.

FM WOBULATOR CAPACITOR

Frequency modulation unit with a permanent magnetic field and a moving coil mechanism driving a metal diaphragm supported at its rim. This diaphragm acts as a moving plate of the frequency modulator capacitor. W/instructions, build TV sweep sig. gen. BRAND NEWea. **\$2.75**
2 for only.....ea. **4.95**

AN/APR5A—Airborne superhet radar search rec. Freq. range 1000 to 6100 MC. Rec. has a 10 MC IF band width operating from 80/115V AC, single phase 60 to 2600 cps. and one amp. at 26V DC—complete with **\$250.00**
tubes

Lavoie VHF 2-Tube battery operated portable frequency meter, designed to measure frequencies from 325-725 MC. This unit is used for variety of measurements on VHF circuits. Unit has a 0-200 microamp meter, time switch. All in metal carrying case, with modulation. Excellent.ea. **\$14.95**

RA-10DA Compass and Communication Receiver—Frequency range: 150-1100 KC; 2.0-10.6 MC. Complete with tubes, dynamotor, 49.50
and control box, New.ea. **\$49.50**

CRYSTAL—100 KC. **\$2.95**

MG-149F—110V AC, 400 cycle-750 **\$9.95**
VA Inverter, Used.each

WRITE FOR NEW BULLETIN AND PRICES.

ALL ITEMS F.O.B. CHICAGO
25% Deposit required with orders

R W ELECTRONICS

Dept. N, 2430 S. Michigan Ave., Chicago 16, Ill.
PHONE: CAIumet 5-1281-2-3

The unit is self-focusing and will work with electrostatic or electromagnetic types and with 52, 70, 72, and 90 degree yokes. It requires no ion trap. The device is currently available as a complete unit or as an assembly without the tube.

"CRT TESTIVATOR"

Century Electronics Co., 111 Roosevelt Avenue, Mineola, New York has recently introduced a "CRT Testivator" which is designed to permit the checking and servicing of cathode-ray picture tubes without removing the tube from the receiver.

The device checks cathode emission, indicates shorts and leakage between elements, tests for opens, and estimates the probable useful life of the tube. It activates the CRT cathode by removing surface contamination, restores emission, and clears inter-element shorts and leakage.

The Model 103 is compact and comes complete with carrying strap, test



cables, and full instructions for its use. A data sheet on this instrument is available without charge from the company on request.

"JUNIOR VOLTOHMYST"

The Tube Division of Radio Corporation of America, Harrison, N. J. is now offering a new "Junior VoltOhmyst" as the Model WV-77B.

Embodying several new features in addition to those included in the earlier versions, the new unit comes completely assembled, wired, and tested as well as factory calibrated.

As a d.c. voltmeter it measures .05 to 1200 volts in five ranges. It reads 100 millivolts to 1200 volts (r.m.s.) on five a.c. ranges and measures resistance from .2 ohm to 1000 megohms in five ranges.

Each unit comes with a slim, single-unit switch-probe and cable. The probe and cable are insulated to prevent accidental short-circuits.

Several accessory probes are available for use with this instrument at slight additional charge.

SUPERIOR "ALLMETER"

Superior Instrument Co., 2435 White Plains Road, New York 67, New York is currently introducing its new Model TV-60 "Allmeter," a complete all-purpose 20,000 ohms-per-volt multimeter.

LIFETIME GUARANTEED TUBES

BRAND NEW PICTURE TUBES

- RCA Licensed
- One Year Unconditional Guarantee

Type	Price	Type	Price
10BP4	\$11.90	17BP4	\$20.63
12LP4	\$14.38	19AP4	\$24.81
14BP4	\$16.86	21AP4	\$28.79
16RP4	\$19.38	21EP4	\$28.79
16LP4	\$19.38	24AP4	\$42.50

Picture Tubes shipped F.O.B. Harrison, N. J. Above types are most popular. However you may order any equivalent size at the same price.

LOOK WHAT YOU GET FREE!

FREE BONUS BOX With Every \$25 Order

- 1 RCA Cheater Cord
- 10 Assorted resistors
- 10 assorted 2 color "blank" tube cartons
- 1 6BQ6GT tube
- 1 6AU6 tube
- 1 6CB6 tube

FREE CLOCK RADIO With Every \$125 Purchase Within 30 Days

Wakemaster clock radio with famous Sessions clock movement wakes you to music or alarm. May be purchased outright from MAJOR BRAND for \$17.95. In ivory or rust.

FREE GIFT CERTIFICATE* worth \$5 toward the purchase of any of our merchandise on future orders will be sent with any order of \$50 or more. * Free Gift Certificate cannot be used to obtain another certificate unless order is \$55 or more.

WE PAY ALL POSTAGE on orders shipped in USA, Territories and APO's. Send only purchase price of merchandise. Please include approximate postage on foreign shipments. All orders subject to prior sale. Add 25c handling on orders under \$5.00. Quantity users write for special discount.

Write For FREE Tube List — Order Blank — and FREE Sample Tube Carton. We want Y.O.U On Our Mailing List!

ALL PARTS SHIPPED F.O.B. HARRISON, N. J.

NEW INDOOR ANTENNA

Both UHF and VHF. Brings better reception than most outdoor antennas. Use on top of TV.

List Price \$9.95

Your Price

Lots of 3 **\$3.29**

\$3.99 each

THIS AD IS Worth M-O-N-E-Y

Clip out this ad and attach it to your order. Three 6SN7GT's will be shipped FREE with any order of \$10 or more.

HERE'S HOW LIFETIME GUARANTEED TUBES

SAVE YOU MONEY!

- We Guarantee to Replace Tubes Labeled MAJOR BRAND Forever
- Each Tube Individually Boxed and Guaranteed
- Over A Half Million Tubes Always In Stock
- Immediate Shipment
- Free Postage On All Orders With Full Remittance
- There are fewer "call backs"
- There are no "out of date" tubes
- "Peak Performance" testing in our fully equipped Testing Department before shipment guarantees quality

02A	.43	5AW4	.75	6BL7GT	.75	6X4	.34	12SK7	.45
12AP	.43	5B6	.80	6BN6	.58	6X5	.34	12SN7GT	.56
12B7GT	.43	5C4	.69	6BQ6GT	.78	6X8	.73	12SQ7	.37
183CT	.65	5U4G	.43	6BQ7	.78	6Y6G	.55	12SR7	.45
185GT	.43	5Y4G	.74	6BY6G	.58	7A7	.43	12T4	.45
1D5GP	.41	5V4G	.59	6BZ	.88	7A5	.53	12V6GT	.45
1E7GT	.41	5V3	.31	6C4	.37	7A7	.45	14A7	.42
1G6GT	.41	5V4G	.36	6C5	.38	7A7	.43	14B6	.38
1H4G	.43	5Z3	.41	6CB6	.49	7A8	.45	14C7	.57
1H5GT	.47	6A7	.57	6CD6G	1.15	7B5	.39	198G6G	1.18
1L6GT	.47	6A8	.45	6D6	.48	7B6	.42	19T8	.65
1L4	.45	6B4	.43	6E5	.44	7B7	.41	24A	.39
1L6	.55	6AC7	.67	6F5	.37	7B8	.45	25AV5GT	.78
1L8	.57	6A7	.79	6F6	.39	7C7	.43	25BQ6GT	.78
1L6G	.47	6A8	.50	6G6	.40	7C5	.42	25W4GT	.43
1L8G	.49	6A9	.69	6H6	.40	7C6	.43	25Z5	.37
1L6S	.47	6A9	.70	6J4	1.79	7C7	.45	25Z6	.37
1LDS	.57	6AK5	.54	6J6	.47	7E6	.55	27	.25
1LCS	.57	6AK5	.39	6J7	.48	7E7	.70	35A5	.46
1LCS	.57	6AK5	.39	6J8	.43	7F7	.59	35B5	.46
1LH4	.64	6AR5	.46	6K6GT	.37	7F8	.70	35C5	.46
1N5	.50	6AS2	.46	6K8	.39	7H7	.50	35L6GT	.47
1R5	.50	6AS7G	2.19	6L6	.68	7J7	.75	35W4	.34
1S5	.40	6AT6	.39	6L7	.62	7K7	.75	35Z3	.39
1V4	.65	6AU6GT	.65	6L7	.62	7L7	.75	35Z5GT	.39
1U4	.47	6AU5GT	.59	6Q7	.40	7N7	.50	37	.29
1U5	.42	6AU6	.42	6S4	.40	12AT6	.66	30A5	.46
1V5	.47	6AV6GT	.65	6S7	.45	12AT7	.66	30B5	.46
1X2	.61	6AV6	.39	6S7	.48	12AZ7	.63	30C5	.50
2A3	.55	6AX4GT	.60	6S8	.41	12AU6	.67	30L6GT	.43
2A4	.55	6AX4GT	.57	6S7	.43	12AU7	.53	50L6GT	.43
2A7	.55	6B4G	.52	6S7	.43	12AV6	.35	76	.76
3A4	.53	6B8	.69	6S7	.45	12AV7	.67	77	.38
3A5	.53	6B8	.69	6S7	.45	12AX7GT	.67	78	.38
3AL5	.45	6BA7	.58	6L7GT	.55	12AX7	.58	80	.34
3AU6	.46	6BC5	.47	6S7	.39	12B4	.68	84/624	1.44
3BC5	.54	6BC7	.80	6S7	.42	12B6	.46	117L7GT	.49
3BN6	.70	6BE6	.43	6S57	.41	12BD6	.46	117N7GT	1.09
3CB6	.52	6BF5	.40	6T4	.95	12BE6	.46	117P7GT	1.09
3C4	.46	6BF6	.50	6T8	.68	12BH7	.60	117Z3	.35
3Q5GT	.57	6BG6	1.15	6U8	.75	12BY7	.65	117Z6GT	.63
3S4	.47	6BH6	.50	6V3	.80	12BZ7	.61		
3V4	.47	6BJ6	.47	6V6GT	.46	12C6	.95		
4B07	.89	6BK5	.68	6W4GT	.39	12SA7	.45		
4B27	.95	6BK7	.76	6W6GT	.53	12S7	.45		

Write Dept. RN-3

MAJOR BRAND TUBE CO.

Romano Bldg.

ESsex 4-1106

Harrison, N. J.

RADIO CONTROL Headquarters
Leading U. S. Supplier of "Citizen Band" (No FCC Test Needed) TRANSMITTERS, RECEIVERS, KITS, RELAYS, ESCAPMENTS, etc.
R C TRANSMITTER & RECEIVER KIT: 27.1 Mc. 5 Watt 2-Tube Simple Transmitter & Supersec. 3-Tube Simple Receiver—Parts incl. Drilled Bases, Wound Coils, Res., Cond., SIGMA Relay, Instruct. ... only \$9.95
BASIC KITS: 2-Tube RBC. \$3.35; 2-Tube XMTK. \$ 4.95
R C BOOKS: "Model Control" \$1; "Radio Control" \$1; "Handbook" \$2.25; CRYSTAL 27.25 Mc. 3.95
Mini Plate RELAY \$4.95; Gyro 6 REED RELAY. 14.95
Teleph. STEPPER SWITCH 2 Deck 10 Pos. 2.1V. 8.95
TRANSISTORS 88c; Code Practice Oscillator Kit. .35
TRANSCIEVER CABINET: 12x17x6 in. w. Handle 2.85
FREE CAT. "R." Send For FREE FCC Form 505
GYRO ELECTRONICS, 325 R CANAL ST., N. Y. 13, N. Y.

High School Course at Home Many Finish in 2 Years

Go as rapidly as your time and abilities permit. Course equivalent to resident school work — prepares for college entrance exams. Standard H. S. texts supplied. Diploma. Credit for H. S. subjects already completed. Single subjects if desired. High school education is very important for advancement in business and industry and socially. Don't be handicapped all your life. Be a High School graduate. Start your training now. Free Bulletin on request. No obligation.
American School, Dept. H396, Drexel at 58th, Chicago 37

SAVE \$\$\$ THOUSANDS OF BARGAINS

Send Stamp for our GIANT CATALOG
UNITED RADIO CO.
58A MARKET ST. NEWARK, N. J.

The MASTER SETS YOU UP!

here's what's in it for you ...

DOLLAR-WISE PURCHASING
Shop before you buy! Do it right at your own bench through the supermarket pages of the industry-wide MASTER. Compare specs and prices first—then buy and save.

A GOLD MINE OF FACTS All the latest info on new products—new models—changes in specs. You name it and it's in the MASTER catalog file of the electronic parts industry.

List \$7.50
As low as **\$2.95**
from parts distributors

- 100,000 items • Complete descriptions
- Specifications—Prices • 11,000 illustrations • 350 mfrs. • 8 x 11", 6 lbs.

UNITED CATALOG PUBLISHERS, INC.
110 Lafayette St., New York 13



1956 edition

FULLY CATALOGS:

TUBES — TRANSMITTERS

TEST EQUIPMENT — COMMUNICATION

RECEIVERS — RESISTORS — COILS

ANTENNAS — TRANSFORMERS

RECORDING & PA SYSTEMS

CAPACITORS — HARDWARE

RELAYS — TOOLS, ETC.

1456 pages

OFFICIAL BUYING GUIDE OF THE INDUSTRY

NOW...

you can replace your ordinary cartridge with a



regardless of the make or model of your record player

The unanimous editorial acclaim by the critics plus the public enthusiasm over the amazing performance of Ronette Fonofluid Cartridges has resulted in a sudden demand for these cartridges.

Today there is a Ronette Fonofluid Cartridge . . . already famous for its high compliance, low intermodulation distortion and full frequency response . . . available in high or low output — turn-over or single needle model . . . in a variety of mountings and brackets designed for replacement in every record player ever manufactured.

Hear all the music you are paying for . . . use a

Ronette

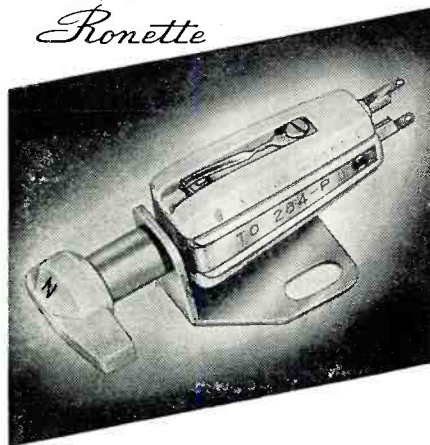

Model TO-284P (Illustrated): with 2 non-interacting sapphire needles \$7.50 net
Other models from 5.40 net

Diamond needles available at extra cost.

RONETTE ACOUSTICAL CORP.
135 Front Street, New York 5, N. Y.

Please send literature describing in detail the entire line of Ronette Fonofluid Cartridges and other Ronette audio components.

Name _____

Address _____

City _____ Zone _____ State _____

This versatile test instrument features a giant recessed 6½-inch 40-microamp meter with mirrored scale that assures accuracy and easy reading. The

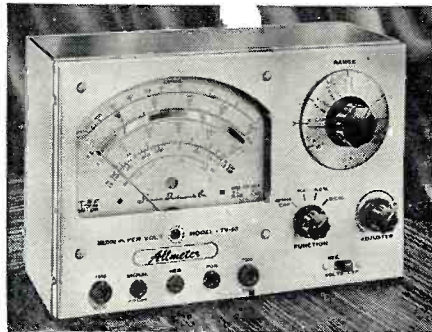

unit can also be used as a direct-reading capacity meter, a kilovoltmeter, an r.f. signal tracer, and an audio signal generator. An r.f. probe can be plugged in to convert the Model TV-60 into an r.f. signal tracer while the audio probe permits its use as an audio signal tracer.

There are eight d.c. voltage ranges, seven a.c. voltage ranges, three resistance and two capacitance ranges, five d.c. current ranges, and three decibel ranges. Write the company for full specifications on this "Allmeter."

CRT CHECKER KIT

Heath Company, Benton Harbor, Michigan is now offering a cathode-ray tube checker kit, the Model CC-1.

The instrument will check any picture tube whether it is in the set, on the workbench, or in its carton. It will test for shorts, leakage, and emission. It features a "Shadowgraph" test (a spot of light on the screen) to indicate whether the tube is capable of functioning.

The Model CC-1 tests all electromagnetic deflection picture tubes normally encountered in TV servicing. It supplies all operating voltages to the tube under test and indicates the condition of the tube on a large "Good-Bad" scale. Spring loaded test switches are used to insure operator protection.



The checker is housed in a portable case and is lightweight for portability on home service calls.

"SENIOR VOLTOHMYST"

The Tube Division of Radio Corporation of America, Harrison, N. J. has announced the addition of the Model

AMATEUR CRYSTAL HEADQUARTERS

FOR THE MAN WHO WANTS
A Rugged Crystal

We have the DC-34 holder you can use with a ½" adapter—man! what output—a big ½" piece of quartz that really oscillates—ground by skilled craftsmen and counted to your exact frequency by our electronic counter.

NOVICE BANDS **79c**
IN 1 KC STEPS
DC-34 OR FT-243 EACH

6-10-20-40-80 METER
HAM BANDS IN DC-34
OR FT-243 **79c**

STOCK XTALS
FT-241
FT-243
DC-34
FT-171 **50c**
EACH

Send postcard for free list of frequencies.

DC-34 HOLDERS

1690	2175	2360	2685	3000	3412	3790	4030	4275
1705	2195	2375	2710	3010	3422.5	3792	4035	4305
1720	2202	2390	2711	3023	3462	3825	4055	4310
1770	2215	2395	2732	3027	3480	3830	4065	4325
1790	2220	2415	2745	3055	3520	3855	4085	4345
1810	2235	2422	2775	3095	3540	3870	4095	4350
1830	2240	2435	2807	3117	3575	3885	4115	4370
1850	2255	2466	2816	3149	3580	3895	4130	4380
1870	2258	2467	2831	3161	3610	3905	4135	4397
2050	2260	2491	2851	3190	3630	3925	4150	4405
2065	2275	2514	2863	3279	3655	3935	4155	4415
2082	2280	2527	2894	3280	3665	3945	4175	4435
2090	2282	2540	2899	3311	3695	3950	4177	4440
2105	2295	2559	2925	3317	3702	3965	4192	
2106	2300	2587	2926	3345	3705	3988	4210	
2142	2326	2605	2960	3365	3745	3995	4215	
2155	2335	2625	2971	3385	3765	4012	4235	
2174	2355	2643	2980	3395	3775	4015	4255	

FT-243 HOLDERS **50c**
5675KC-8650KC IN 25KC STEPS

FT-241 LATTICE XTALS **50c**
ALL FREQ. FROM 370-540KC
500KC CRYSTALS \$1.00

TEXAS CRYSTALS

"The biggest buy in the U. S."

P. O. BOX 1912, DEPT. R
FORT WORTH, TEXAS

TERMS: All items subject to prior sale and change of price without notice. ALL crystal orders MUST be accompanied by check, cash or M. O. WITH PAYMENT IN FULL. NO C.O.D. Postpaid shipments made in U. S. and possessions only. Add 5c per crystal for postage and handling charge.

WV-98A "Senior VoltOhmyst" to its line of test equipment.

The new unit is an ultra-modern v.t.v.m. for the all-round testing of TV, FM, AM, and high-fidelity sets. Its features include all of those incorporated in the earlier models of this unit but, in addition, has an extra large (6½" wide) full-vision meter face with easy-to-read scales. This instrument reads peak-to-peak voltages directly which is of particular advantage in TV receiver servicing.

The WV-98A also features a new single-unit a.c.-d.c.-ohms probe that has a built-in switch for instant selection of d.c., a.c., or resistance functions. Over-all accuracy on both a.c. and d.c. voltage scales is ± 3 per cent of full-scale values. -30-

Guided Missiles

(Continued from page 37)

cuits, gate circuits, and bistable relay circuits. Each tone burst must remain in close time relation with all other pulses; thus, the maintenance technician must carefully check these timing and synchronizing circuits.

The transmission of radar, timing, and other types of information depends not only on the submarine cable, but other communication facilities. Extensive h.f., u.h.f., and v.h.f. radio networks provide long and short range communications. The h.f. radio, using directional antennas, links the more remote areas of the range with Cape Canaveral while u.h.f. and v.h.f. systems provide point-to-point, and air-to-ground communications. An automatic dial telephone system provides administrative contact with each station. Special telephone circuits link instrumentation operators during a missile test. Thus, a technician also has a variety of communication equipment to maintain. Whether it is radar equipment or communication equipment, the need for preventive maintenance is the same.

Preventive Maintenance

Considering the complexity of the radar data system, one can easily realize the problems of keeping all equipment on the range in peak operating condition. Design and construction play a big part in achieving reliability; however, reliability can only be fully realized by systematic maintenance. Ideally, each potential trouble should be detected and corrected before it occurs. To reiterate, the systems of equipment that are used to gather missile performance data may be compared to series-connected tube heaters. When one part of the system fails, the entire system fails. This means that each piece of equipment in the system must operate for long periods of time without failure.

The Preventive Maintenance Program that is now used on the range, was initiated to standardize maintenance procedures and to furnish the maintenance technician with complete

information on the equipment. In part, this program involves the preparation of manuals that contain illustrations and complete information pertaining to setup procedures, testing procedures, lubrication instructions, etc. Special record forms, logs, and check lists are furnished with each manual. Maintenance drawings that simplify schematic and wiring diagrams are prepared and distributed to field personnel. Maintenance inspectors are constantly in the field to assist the maintenance technicians, and through reports, pass on suggestions that improve equipment operation and raise the general maintenance level for the complete operation.

Through a comprehensive training

program, new technicians are thoroughly oriented and become familiar with the equipment that they will maintain. This program also provides training for seasoned personnel in the field. In this way all technicians have the opportunity to advance in both the theoretical and practical phases of their work, and, of course, promotions depend on the individual.

Those in the field of electronics who appreciate the variety and complexity of the equipment used in the testing of guided missiles, must also realize the trend and implications of guided missile research. The maintenance phase alone offers unprecedented opportunities for those with electronic experience. -50-

PAYS ITS WAY every day

**TESTS and
REPAIRS
TV PICTURE
TUBES**

**Makes Customers Happy
— Creates New Profits**

Servicemen now earn new servicing dollars in minutes and build satisfied customers—with B&K Deluxe Portable CRT 400.

Spots and corrects picture tube troubles in a few minutes, right in the home, without removing tube from set! Restores emission, stops leakage, repairs inter-element shorts and open circuits. Grid cut-off reading indicates picture quality customer can expect. Life-test checks gas content and predicts remaining useful tube life. Cuts operating costs, eliminates tube transportation. Also saves money on TV set trade-in reconditioning. Profits start the very first day.

Send for Bulletin 104-N



DELUXE CRT 400 with 4½" Plastic Meter

Weights only 5 lbs. mounted in rugged, luggage style, carrying case covered with handsome, durable leatherette. Size: 11 x 7½ x 5". **Net \$54.95**



ECONOMY CRT 200

Every serviceman can cash in on picture tube repairs with this low priced quick profit maker. Performs most of the functions of the CRT 400. Has 3" meter. In leatherette carrying case. Size: 11 x 7½ x 5". Weighs 5 lbs. **Net \$39.95**

**PROVEN IN
THE FIELD
EVERY DAY
BY OVER
20,000
SERVICEMEN**

Made by the Makers of the DYNA-QUIK Tube Tester

B & K MANUFACTURING CO.
3726 N. Southport Ave. • Chicago 13, Illinois



BARGAINS IN OUTSTANDING SURPLUS ELECTRONICS!

50-WATT, 6-CHANNEL RADIOTELEPHONE

THE RADIOTELEPHONE BARGAIN all the Pleasure and Fishing Boats are talking about! Act Fast, for Spring installation, while we still have some in stock. This Transmitter-Receiver (BC-669, part of SCR-543) is beautifully and ruggedly built. Provides 6 fixed channels of crystal-control transmission and reception, in addition to manual tuning when desired, for reception. Frequency 1600 to 4500 KC. excellent for 2-3 mc marine band. With recommended 12 V. DC (or 24 V. DC) dynamotor power supply will deliver 50-60 watts output. Supplied with instruction book, connecting cable, power supply construction data, all tubes, all tested and guaranteed. See our Ad in Jan. '56 Radio Telev. News for illustration and complete data, or send for descriptive bulletin!

50 W. RADIOTELEPHONE (BC-669 A, B, or C), USED-EXCELLENT, as described above. **\$99.50**
Shpg. wt. 185 lbs. EACH
SAME AS ABOVE, NEW-UNUSED, EACH. **\$139.50**
PE-110 A, B, or C POWER SUPPLY, for 110 V. 60 cycles AC operation, LIKE NEW condition, EACH. **\$89.50**
TS-11 HANDSET, with appropriate plug connector **\$14.50**

3-RANGE SIGNAL GENERATOR

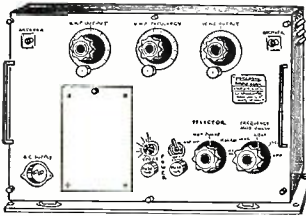

Well-built and highly engineered, this test signal generator is a rare bargain for laboratories, service shops, and for production testing in factories. Known as the Q.V.-1 Test Generator, it provides in any one or all of 3 outputs; (1) 100 kc. output variable from 150 to 250 mc.; (2) a 15 mc. output (which can be changed to another nearby frequency by alignment); and (3) Multivibrator output of 1, 1.0, 10.0 and 100 KC by means of a selector switch. Frequency stability is excellent and calibration at least as good as any excellent service signal generator, including following tubes 1-5Y3GT, 1-6SL7, 1-6AC7, and 2-6X4. Operation is from 110 V. 60 cycles, 1-phase AC. Dimensions are L-19 1/2", H-13 1/2", D-7 1/2". Shpg. wt. 85 lbs. NEW units, with operating instructions and schematic. ONLY. **\$24.95**

600 W. A.F. POWER AMPLIFIER



Designed by Bell Telephone Laboratories, ruggedly constructed, 600 Watt Audio Power Amplifier. Ideal for use in airports, shipyards, or wherever high intensity sound may be required. Excellent for conversion to Modulator Unit for modulating 1 KW transmitters. Comprises push-pull audio power stage utilizing 4-805 power triodes in push-pull arrangement with built-in motor blower for cooling. High voltage power supply uses selenium rectifiers, no tubes. Requires 40-60 volt pre-amplifier to drive to full capacity. Input impedance 250/500 ohms, output impedance 13/6.5 ohms to speakers. Operates from 115 to 230 Volts, 3 phase 50/60 cycles AC. Dimensions of wooden chest 24 3/8" x 28 7/8" x 21 1/4". Supplied with tubes, connecting cable, schematic diagram, etc. Shipping weight 290 lbs. PRICE EACH, SLASHED TO. **\$169.50**

600 W. LOUSPEAKER

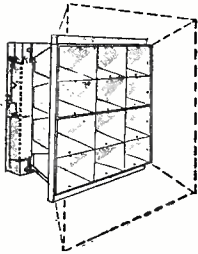

designed for use with above Amplifier, consists of two 6-unit sections which bolt together to form 12-speaker unit shown. Dotted lines show how sections are extended. Additional sections may be added for improved low-frequency response. Dim. of 6-speaker section 29 1/2" L x 15 3/8" H x 21" D. All steel construction. Uses loudspeaker units illustrated below. UNUSED. Shpg. wt. 225 lbs. PRICE: PER 6-Speaker section, \$75.00.

DM-35 DYNAMOTOR

Ideal for Marine, Ham-Mobile, and Mobile PA eqpts. rated at 625 volts DC output at 225 ma., 12 V. DC INPUT. THESE UNITS ARE NEW, IN ORIGINAL EXPORT PACKING, with Spare Brushes, etc. Don't be misled or confused by reconditioned or slightly-used lower priced dynamotors quoted as guaranteed. Receive this Dynamotor to be as represented! Shpg. wt. 17 lbs. THESE ARE A REAL BUY. EACH **\$13.95**

All Above Material Subject to Prior Sale. 25% Minimum Deposit with All C.O.D.'s. Min. Order—\$5.00. All Prices F.O.B. Our Address.

TELEMARINE COMMUNICATIONS CO.

3030 W. 21st Street, Brooklyn 24, N. Y.
Phone: ESplanade 2-4300

V.H.F. TEST EQPT.



troil, T-connector, and a 100 ohm resistor. Shpg. wt. 50 lbs. EACH. **\$49.50**

A Complete Test Instrument covering 150 to 230 mc. operating from 110 V. 50/70 cycles AC, and for Navy Model 107A. Permits following functions: (1) Tune a transmitter to given frequency. (2) Tune a receiver to a given frequency. (3) Adjust antenna system for best performance. (4) Measure power output of a transmitter. (5) Check wave shape of transmitter's output with auxiliary oscilloscope. (6) Monitor a transmitter during operation. Incorporates: Calibrated Tuned Absorption-Type Wave-meter; Signal generator; Detector-amplifier circuit with electronic indicator which shows exact resonance with amplified signal, plus an untuned VTVM input connection so that this circuit will serve as a voltmeter. All housed in a metal cabinet, with cover, 13 1/2" L. x 8 1/2" H. x 10 1/2" D. Includes calibration chart, separate receiver gain control cord, LIKE-NEW condition. **\$49.50**

LIMITED QUANTITY BARGAINS

32 V. DC to 110 V. AC ROTARY CONVERTERS. Mtd. by Kato, for marine or farm use. Shock mounted, with input and output filtering. Operates from 110 V. 50/60 cycles to 300 W. Shpg. wt. 60 lbs. NEW UNITS, EACH. **\$49.50**
LINK 9U4R AM 30-40 MC RECEIVERS. Can be set up for any frequency in 30-40 mc range crystal-control. Designed for rack mtg., with built-in 110 V. 50/60 cycles/1 phase. NEW UNITS, EACH. **\$49.50**
PE-218 CONVERTERS. 24-225 V. DC Input, 110 V. 400 cycles/1 phase. 500 VA. Output. NEW UNITS, EACH. **\$14.95**

32 V. DC to 110 V. AC ROTARY CONVERTERS. Mtd. by Kato, for marine or farm use. Shock mounted, with input and output filtering. Rated at 225 Watts, will deliver up to 300 Watts. Shpg. wt. 60 lbs. NEW UNITS, EACH. **\$14.95**
PE-104, 6 or 12 V. DC VIBRATOR POWER SUPPLY. For SCR-286 Receiver, or other transceivers or mobile receivers. Uses synchronizing vibrator, fully shielded. Dim. 3" x 4 3/8" x 6 1/8". Shpg. wt. 12 lbs. NEW UNITS, EACH. **\$14.95**
SPARE VIBRATOR, for above, EACH. **\$7.50**

BEACHMASTER 250W. AUDIO AMPLIFIER. Super-Power Audio Amplifier, designed by Bell Tel. Labs., all self-contained waterproof case. Ideal for outdoor applications, Operates from 110 V. 50/60 cycles AC. Complete with 14 tubes, including 8-805's for push-pull power stage. Dim: 26 1/2" x 16 1/4" x 19". Shpg. wt. 190 lbs. Used-Excellent condition. **\$169.50**

PAE-2 ELECTRIC MEGAPHONE. Mtd. by Remler for a long distance. Consists of Horn and Assembly, includes Microphone, Reproducer, Trigger Switch, and Connecting Cable; and a Portable Amplifier with self-contained Power Supply and 14 Tubes, fully shielded. Will beam voice over 500 yards or more outdoors. Charger and Storage Rack for 110 Volts AC or DC operation. Available separately. Mtd. by Remler. Dim: 20" H. x 13 1/2" W. Portable Amplifier Dim: 13 3/4" H. x 13 3/4" W. x 13 3/4" D. Complete with tubes, connecting cables, Inst. Books, U.S. Patent. Shpg. wt. 85 lbs. PER SET. **\$79.50**

STORAGE & CHARGING RACK, for above. Operates from 110 V. AC or DC. Charges 14 tubes. Full cut tapering rate. Dim: 15 1/2" H. x 18 1/2" W. x 13 1/4" D. **\$19.50**
Unused condition. Shpg. wt. 55 lbs. EACH.

BC-24 RECEIVER FOR MARINE OR MOBILE. Operates from 12V. DC (Intercom) or from 110 Volts to 180 mc. Similar to BC-312 and 348 in appearance. Includes BFO for CW reception, Crystal Filter Circuit, Standby Switch, and many other features. Used-Excellent Condition. Shpg. wt. 35 lbs. **\$79.50**

SCR-522 TRANS-RECEIVER. In case CS-80. AM transmission-reception from 100 to 1500 kc. crystal controlled channels, operates from 12, 24 V. DC or 110 V. AC power Supplies. Excellent Condition with tubes, no accessories. Will quit on accessories upon request. Shpg. wt. 75 lbs. EACH. **\$69.50**

48 DC to 110 V. AC, 3-PHASE, 2KW, ROTARY INVERTER, like-New units. Ideal for marine, farm, and farm installations to obtain AC power for operating AC devices. Compact. Shpg. wt. 275 lbs. **\$95.00**

RECTIFIER RA-20. 110 V. AC to 250 V. 100 MA DC. Compact Transformer-type all-shielded Power Supply for all receivers or test equip. Completely filtered output, with fuse and on-off switch. Response from 100 to 1000 dynamotor operated receivers to AC operation. Supplies 1.6 V. AC for heaters. Used-Excellent Condition. Dim: 6 3/8" x 9 1/2" x 5 3/8". Shpg. wt. 20 lbs. **\$15.95**

RCA IP25 INFRARED IMAGE CONVERTER TUBE, used in American Spotscopes and Nightscopes. All NEW, UNUSED Condition. Shpg. wt. 8 lbs. **\$49.50**

60 W. WESTERN ELECTRIC SPEAKER UNITS, for straight backward or haffle-type mounting. Features shock and blastproof diaphragm. Response to 7,000 cps, favoring high freq. Impedance 13 ohms. Dim: 6" x 6" x 4 1/2" deep. Throat 1 1/2". Shpg. wt. 20 lbs. 5 slug wt. approx. 6 lbs. Shpg. wt. 20 lbs. **\$11.95**

EACH BC-745 POGO-STICK TRANS-RECEIVER. Single freq. crystal controlled trans. and recvr. Freq. range 2-6 Mc. Output 34 watt. Range approx. 5 miles. For emergency communications, etc. Complete with tubes, connecting cord CD-571, and 1 BC-746 Tuning Unit. USED. GOOD CONDITION. Shpg. wt. 15 lbs. EACH. **\$39.50**

SAME AS ABOVE, NEW CONDITION—EACH. **\$39.50**
CHEST-UNIT T-39, Excellent Condition. Shpg. wt. 5 lbs. EACH. **\$15.00**
POWER SUPPLY PE-157, with internal 3 Volt Storage Battery. Exc. Cond. Shpg. wt. 15 lbs. EACH. **\$24.50**

ADDITIONAL BC-746 TUNING UNITS, with crystals. Specify preferred frequencies. EACH. **\$2.95**
SPARE TRANS-RECEIVER & CHASSIS, NEW, BC-745, less tubes. Shpg. wt. 8 lbs. EACH. **\$12.95**
O-1.5 AMPS RF AMMETER, WESTON Model 107, 2 3/8" Metal Heavy die. Built-in thermocouple. Black dial silver numerals. EACH. **\$5.95**

SELECTIVE RINGER for MOBILE or MARINE RADIOTELEPHONES



Use with any receiver in Marine or Mobile operating with Bell Telephone system. Permit Phone Operator to call your Radiotelephone exclusively, when operator has a call for you, by ringing a bell or lighting a light. Designed & Mfd. by Western Electric, MODEL 107A, modern, compact and efficient. Can be attached to any receiver, complete instruction Book supplied. Dim.: 1 5/8" long, 8 1/2" high, 3 1/8" wide. Shpg. wt. 23 lbs. NEW UNITS, Reg. value \$245.00 each. GUARANTEED SATISFACTORY! OUR LOW PRICE—EACH. **\$85.00**

SAFETY DIODE PROTECTS TRANSISTORS

By RUFUS P. TURNER

ACCIDENTALLY reversing the battery in transistorized equipment often means quick and complete ruin of the transistors. Unless an operator is on the alert every minute of the time, he can easily make this expensive mistake.

In most transistorized devices such accidents can be prevented simply by connecting a germanium or silicon-junction diode in series with one of the "D.C. Input" terminals, as shown in Fig. 1A. The diode acts as a polarity-sensitive switch, and should be built into new equipment from the very beginning.

The diode is poled so that only an extremely small current flows when the battery is reversed. This current is too small to damage the transistors. As shown in Fig. 1A, the anode of the diode is connected to the positive d.c. terminal. This polarity allows high forward current to flow through the diode to the circuit. When the battery is reversed, however, the anode is polarized negative and the diode resistance goes up—often several thousand times the forward resistance. The minute reverse current passed by the diode in this condition can cause no damage to the transistors.

The natural internal resistance of the diode causes a voltage drop across the diode when the latter is carrying current. The voltage at the transistor circuit therefore is somewhat less than the battery voltage and is equal to the battery voltage minus the diode drop. When this voltage drop is appreciable, the battery voltage may be boosted by this amount to offset the loss. Fig. 1B shows the approximate voltage lost across a 1N34 diode at various common transistor currents. The loss will be lower with low-resistance diodes, such as Type 1N455 and with gold-bonded types.

The safety-diode scheme usually is unsatisfactory in class-B transistor amplifiers because the collector current in these circuits swings (on signal excitation) from a few microamperes up to a sizable number of milliamperes. The diode loss accordingly is large and fluctuating and it will both reduce power output and increase distortion. —50—

Fig. 1. (A) Safety-diode connection and (B) the voltage loss in a 1N34 diode. See text.

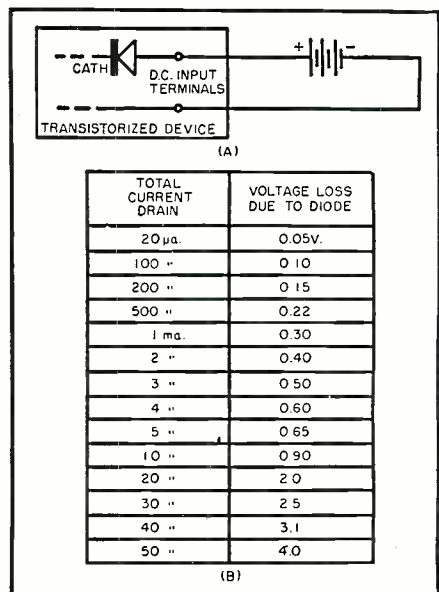

hi-fi

ANNUAL

& AUDIO HANDBOOK

COMING MARCH 6th!

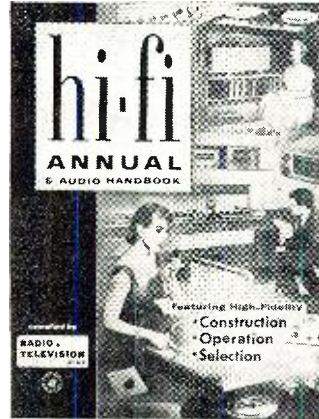

Whatever your interest in Hi-Fi—as a builder of your own rig, or simply as a lover of good music—you'll find a wealth of practical and authoritative information in HI-FI ANNUAL & Audio Handbook, on sale at newsstands and radio parts stores March 6, 1956.

Edited by the staff of RADIO & TELEVISION NEWS, the World's Leading Electronics Magazine, HI-FI ANNUAL & Audio Handbook brings you—between the covers of a single volume—a total of 42 carefully selected articles on everything in Hi-Fi . . .

- * SELECTING HI-FI EQUIPMENT
- * PREAMPLIFIERS
- * EQUALIZERS & TONE CONTROLS
- * POWER AMPLIFIERS
- * LOUDSPEAKERS & ENCLOSURES
- * TAPE TRICKS WITH YOUR HOME RECORDER

. . . plus a complete bibliography of Hi-Fi technical books and a handy product directory.

If you're a Hi-Fi fan—and who isn't today?—HI-FI ANNUAL & Audio Handbook is "must" reading . . . will save you money . . . show you the way to more enjoyment from your hobby. Only \$1.00.

BE SURE TO GET YOUR COPY!
ON SALE MARCH 6, 1956

at Newsstands and Radio Parts Stores



HI-FI ANNUAL & Audio Handbook 366 Madison Ave. New York 17, N. Y.

SAV dough! / HARJO!

- POSTPAID SPECIALS!**
 * Yup! We pay all postage charges for items in this box! Buy now and save!
- VEEDER-ROOT COUNTER**
 With re-set, precision right-angle drive and pulley! Three-digit scale (to 999) measures wire, fishing line, tape, film, etc. Brand new. Postpaid only. **\$1.95**
- BE-51 TELEPHONE TEST SET**
 Contains three-inch 5 mil DC meter. Enclosed in heavy duty leather case with neat shoulder strap and test lead. This beauty is easily adapted to use as mobile test meter. Brand new. Postpaid. **\$4.49**
- VHF ANTENNA**
 Small—but a powerhouse! Only 1 3/4" high. Complete with mount and coax fitting. New boxed, postpaid. **\$1.49**
- BUTTERFLY CONDENSER**
 For TN3B Tuning Unit. Tuned to approximately 300-1,000 MC. New, boxed, postpaid. Special at only. **\$2.95**
- HOUSE THERMOSTAT**
 Here's a saving of at least 60%! This unit, a product of a national manufacturer, can be manually set to maintain any temperature from 40 to 100 degrees F. It's new, boxed, precision built, worth a lot more, sent postpaid for only. **\$2.95**
- PHOTOFLASH CONDENSER**
 Hy. Shutterbugs! This is for you! 30 mfd @ 2,000 VDC. Regular \$14.95. Brand new. Postpaid. Only. **\$4.95**
- MINIATURE LINE MATCHING XFRMR**
 * Blocks oscillators on TV camera input circuits on TV receivers, for transistor circuits, electric organ, digital computer system, 1,000's * other uses. Original cost \$14.00. Postpaid **\$1.00**

ARC-4 VHF TRANSMITTER-RECEIVER
 For 2-meter, CAP, novice, etc. Excellent condition. With tubes and crystals **\$19.50**

TELEVISION CAMERA R.C.A. New! Surplus!

for Labs!
 Export!
 Industrials!
 Medicine!
 Closed Circuit
 TV!

COMPLETE WITH ICONOSCOPE & F4:5 LENS
 Labs, hobbyists, industries, TV technicians—set up your own telecast system! It's a "mechanical eye" for factories, prisons, swimming pools, closed circuit TV—100's other uses! Iconoscope, 6-stage video amplifier and clipper. View pilots, movies on closed circuit! Write for complete data. Limited quantity.

701-A TETRODE
 Just the tube for the 1 K.W. SSB final—Fil.: 8 V. @ 7.5 amps. Plate: 300 V. @ 50 ma. Screen: 280 V. @ 50. Just 10 W. to drive pair 1 K.W. A.M. Ea. **\$2.95**

701-A FILAMENT TRANSFORMER:
 For above tube. **\$2.95**
701-A SOCKET: For above. Each \$1.50. 2 for **\$2.95**

W.E. TELEPHONE HANDSET
 Complete with cord. Checked out. Excellent condition. Guaranteed. Each **\$2.95**. Pair **\$5.00**

APS-13 BRAND NEW! SPECIAL!
 Complete with tubes and dynamotor. Only **\$9.95**

HEAVY DUTY MOBILE ANTENNA MOUNT
 Rugged as a rock! Ideal for home, vertical, mobile, marine, B'cast or commercial installation. Unbreakable bakelite base. Single hole mounting. Spring height 6 1/2". Overall height 11". Ship. wt. 10 lbs. New in orig. **\$2.95**
 box. A \$15.00 value. Only

\$2.95 ANY METER HERE! \$2.95!
WESTINGHOUSE: 3" Rd. New. 0-15 mls. DC **\$2.95**
WESTINGHOUSE: 3" Rd. New. 0-5 amps. RF **2.95**
WESTON: 4" Rd. Excel. 100-1000 m. DC **2.95**
DE JUR: 3" Rd. Excel. 1 mil movement. DC **2.95**
BURLINGTON: 3" Rd. New. 500-0-500 microamps **2.95**

SPECIAL! LZ "S" BAND TEST SET!
 Complete with tubes and meter. Excellent condition. Worth three times the price! **\$99.50**

GN-39 DUAL OUTPUT D.C. GENERATOR
 Puts out 1,000 V. @ 350 ma. 12 V. @ 25 amps. Generator may be driven from fan belt of car, auxiliary pulley on rear wheel, or by a direct coupled gasoline engine. Great unit for Field Day! **\$12.95**
 BRAND NEW! Ship. wt. 100 lbs.

1-222 SIGNAL GENERATOR-MICROVOLTER
 Freq. range: 8-15 Mc. & 150-230 MC. Complete with all tubes and 5 MC Calibrating Crystals. Self-contained 110 V. and 60 cycle power supply. With Schematic. Excellent cond. Cost the Govt. approx. **\$39.95**
 \$700.00. ONLY.

STOP & SWAP! We buy items! What have you?

25% deposit on all C.O.D. Min. order \$3.00
 All items F.O.B. Whse., subject to prior sales and change of price without notice.

Harjo Sales Co.
 Office-Warehouse: Dept. R-3, 503 N. VICTORY BLVD., BURBANK, CALIF.

RADIO TV TUBES

What I Buy

Dynamic

High Fidelity For Less

Sales Aids

FLASHLIGHT DISPLAY
 Bright Star Industries of Clifton, New Jersey has had Raymond Loewy Associates design a full-color display for its line of chrome flashlights.

These counter displays were designed specifically to merchandise the firm's 98 cent unit. The direct, lively presentation of the merchandise is

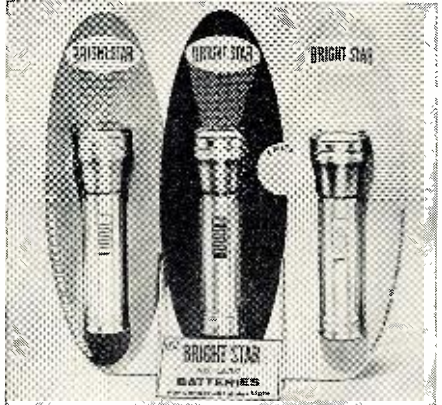

especially suitable for spot selling by service shops and electrical appliance stores.

Contact local Bright Star distributors for complete details on the #616 display and the flashlight line.

"CONVERTER DEPARTMENT"

In order to merchandise its complete line of vibrator-powered converters, Radiart Corporation, 3455 Vega Avenue, Cleveland, Ohio is offering to distributors a free "Consumer Department," two-color metal rack which displays samples of the firm's "Vipower" line.

Occupying less than 2 1/2 feet of floor space, this handy and effective merchandiser will carry a representative



selection of special, lightweight, standard, heavy-duty, and super-heavy vibrators from the company's line of some 45 units. The line ranges in outputs from 2 watts (for the "Shaver Pak" unit) to 350 watts.

SELF SELECTING ELSCO NOISE REDUCING ANTENNAS

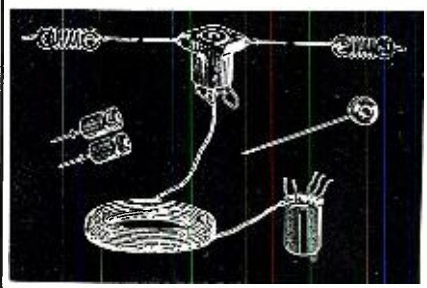

For years, the answer to noise-free reception for AM and FM Services—Engineered for peak performance in the Broadcast-Intermediate Short Wave and FM Bands. Recommended and used by government agencies, public institutions, schools, Shortwave listeners. Hams and many others who demand the best in reception, under the worst of conditions—Only ELSCO still manufactures such an antenna system that is automatically tuned to the signal you select for maximum performance.

Also available is the ELSCO Master Antenna Systems capable of handling from 15 to 25 or more outlets, (depending on strength of available signal) without amplifiers or power supplies. Ask for special bulletin. Antennas cut for any special service bands.

Write now or contact your favorite Distributor.
ELECTRONIC SPECIALTIES MFG. CORP.
 76 Irving Street
 Worcester 10, Mass.

ONLY LEONARD RADIO CAN...

offer these **HIGHEST QUALITY**—high fidelity—**WILLIAMSON-TYPE OUTPUT TRANSFORMERS** . . . at the world's **LOWEST PRICES!**



TRANSFORMER MODEL #LR-100-1
Specifications:
 Frequency range—20 cps—30 kc
 12 watt
 6A Q5 and 6V6 push pull
 Weight—5 lbs.
 NET. **6.75**

TRANSFORMER MODEL #LR-100-2
Specifications:
 Frequency range—20 cps—30 kc
 24 watt
 6L6, KT66 and 5881 push pull
 Weight—6 lbs.
 NET. **13.20**

TRANSFORMER MODEL #LR-100-3
Specifications:
 Frequency range—20 cps—30 kc
 48 or 70 watt
 70 watt: 6550 push pull
 48 watt: 6L6, KT66, 5881 push pull parallel
 Weight—15 lbs.
 NET. **26.25**

* For further information and details write to Dept. 3.
 * COMING SOON!—The Leonard Radio AUDIO REFERENCE GUIDE of 1956. Write for details on how you may obtain a copy.
 Mail and phone orders filled. 25% deposit, bal. C.O.D.

LEONARD RADIO, INC.
 69 Cortlandt St., New York 7, N.Y. COntlandt 7-0315

Distributors desiring information on how they may obtain this display should contact either their regional representatives or the manufacturer direct.

CBS-COLUMBIA CAMPAIGN

An integrated marketing program of merchandising, advertising, promotional power, service and sales training, service and public relations all tied to definite sales objectives has been outlined by *CBS-Columbia* for the benefit of its distributors and dealers.

The program will be aimed at influencing the buying actions of the ultimate consumer. The company will use a series of individual market-area campaigns, based on practical experience and testing with increasing attention being paid to individual market opportunities for both replacement as well as primary selling.

The television firm will use radio, TV, newspapers, magazines, direct mail, point-of-sale, and cooperative advertising to merchandise its line of receivers. Plans for this campaign are in the hands of the company's regional distributors.

"RECORDING TAPE DEPARTMENT"

A self-service "Recording Tape Department" is now being offered by *ORRadio Industries, Inc.*, Opelika 2, Ala., as an aid to merchandising its line of "Irish" brand magnetic tape.

The "Department" is built around a specially-designed wire rack merchandiser with pocket dispensers for the company's literature. Six types of the company's leading tapes are included



with the unit: "Double Play," "Long Play," "Shamrock #300," "Green Band," "Professional," and "Brown Band." Each is packed in an attractive two-color, self-selling display carton with brief technical information and sales tips on the back panel.

TUBE INVENTORY CONTROL

A practical method of visual tube inventory control by means of which a service dealer can keep his tube needs literally at his fingertips has been developed by the Tube Department of *General Electric Company*, Schenectady, 5, New York.

The new system, called the "See-Lect-a-Tube" method, is now available to radio and TV service dealers

March, 1956

NEW The Solution to Your Troublesome **INTERMITTENT** Problems!

Model SL10
SECO
MONITRON

SIGNAL TRACER AND INTERMITTENT LOCALIZER

\$119⁵⁰ ... monitors circuits without attention

NEW for Television and Industrial Use

In servicing TV receivers, transmitters and similar electronic equipment where the output signal does not energize a sound producing indicator, a device is needed to actuate visible and audible alarm in case of a break in the signal path. The Seco MONITRON does just that and more!

Performs 4 basic functions:

1. Monitors circuits without attention.
2. Monitors 2 circuits at once (on same or separate chassis.)
3. Operates as a signal tracer.
4. Makes point to point gain measurements.

Another Serviceman's Timesaver joining these indispensable Seco Testers.

Model GCT-5
GRID CIRCUIT
TUBE TESTER

Model FB-4
FLYBACK CIRCUIT
AND INDUCTANCE
ANALYZER

Your Jobber has 'em or write for information.

SECO MFG. CO. 5015 Penn Avenue S.
Minneapolis, Minn.

50 WATTS FROM YOUR WILLIAMSON

New DYNACO A-430

Output transformer and simple circuit modifications let you raise the power of your Williamson-type amplifier to over 50 watts at less than 1% I M distortion. This super-fidelity output transformer will give you **double power** and **double listening pleasure** with very low distortion and unequalled transient bandwidth. Its unique design uses para-coupled windings, the first basic advance in quality transformer design since the introduction of interleaved windings.

\$29⁹⁵

Write for details of new Dynaco output transformers, circuits, and conversion data for Williamson Amplifiers.

DYNA COMPANY, 5142 Master St., Phila. 31, Pa.

Grommes

BEST BUY IN HI-FI

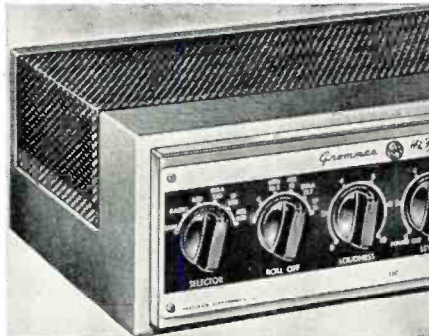

55-C "FLAT SIX" AMPLIFIER

Grommes high-fidelity amplifier. Output: 12 watts. IM distortion less than 1%. Response ± 0.5 DB, 15 to 30,000 CPS. Built-in pre-amplifier with separate roll-off and turnover controls. Loudness control. Calibrated bass and treble controls. Feedback throughout; 4 loops used. \$79.50 net.



GRT-1 FM-AM TUNER

Grommes matching high fidelity FM-AM tuner. Compact, yet full size performance. 2 Mv sensitivity. Tuning eye. Full AFC. Cathode follower output. \$129.50 net.

FREE! NEW 1956 CATALOG

GROMMES Division of PRECISION ELECTRONICS
9101-R King Ave., Franklin Park, Ill.

Name _____

Address _____

City _____ Zone _____ State _____
105-55

through authorized G-E tube distributors. The system was developed after careful study of the number, types, and sizes of tubes most dealers keep in stock for replacement. It features dis-

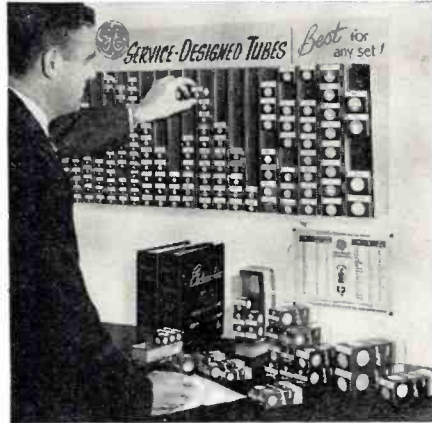

penser units which hold 250 tubes in less space than any method previously devised. The system can be used for over-the-counter sales or service bench work.

Although only 38 inches long, the unit holds its capacity load of 250 tubes in six different size cartons. It is designed to be mounted on the wall. The dispenser is made of heavy gauge steel with a blue-gray baked enamel finish. It is shipped pre-assembled and includes all necessary wall mounting hardware.

DISTRIBUTOR IDENTIFICATION

Tescon TV Products Co., Inc., Springfield Gardens, New York has instituted the local imprinting of the distributor's name on the exterior of its antenna cartons.

Each antenna thus imprinted is pre-assembled and area-engineered to the

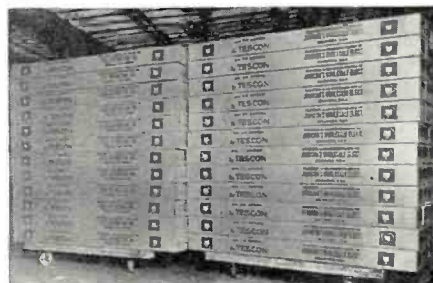

individual distributor's requirements for his part of the country. The company is supplying this service on all initial orders of 500 antennas from the distributor.

With the distributor's name imprinted right in the center of the box, his identity is carried into every service outlet he sells. When it is time to re-order the distributor's name is readily available as a reminder.

"VOLTA-CHEK" DISPLAY

Electronic Test Instrument Corp., 13224 Livernois Ave., Detroit 38, Michigan has developed a compact and colorful merchandising display for its "Volta-Chek" picture tube voltage tester.

The display carton is designed to hold six of the separately boxed test

units. It carries a hard-hitting sales message in a high-reader-impact color combination of red and black.

The display carton is being supplied without charge with orders of six of the "Volta-Chek" units. Write the company for full details.

SOLDERING KITS FOR HI-FI

Weller Electric Corporation, 808 Packer Street, Easton, Pa. is making a concerted drive for the do-it-yourself hi-fi market with the introduction of a soldering kit designed for audio work.

The kit, Model 8100K, contains the company's 100-watt soldering gun with "on-off" trigger for instant heat, the firm's soldering aid for tight wire twists, a wire cleaning brush, and a supply of Kester resin-cored wire solder.

A companion display card acts as a silent-salesman recommending the use of this equipment in assembling high-



fidelity components. The entire "package" is intended to be displayed in the audio sections of parts distributors' stores.

RESISTOR PACKAGING

Dale Products, Inc. of Columbus, Nebraska is now packaging its "Dalohm" Type RS miniature power resistors and Type DC deposited carbon resistors in a new handy "strip" package holding twenty units.

The major advantages of the new package are easy identification, maximum protection, simplified inspection and testing, and streamlined stock-handling and stock control.

Any number or all of the resistors, which are always in full view, may be

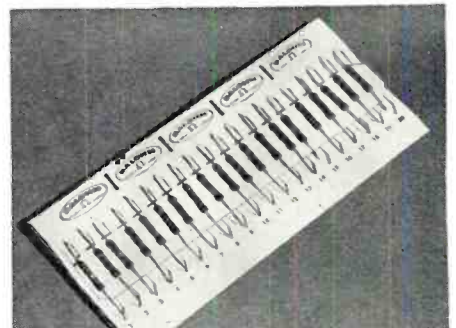

removed quickly and easily. They can be tested and inspected without being removed from the package.

Ham Special! Famous BC-645 XMITTER-RECEIVER



BRAND
NEW

With DIAGRAM for Easy Conversion to CITIZENS' BAND! Makes wonderful mobile rig for 420-500 Mc. Easy to convert for phone or CW 2-way communication. CONVERSION DIAGRAM INCLUDED. This sweet rig originally cost over \$1000—yours for practically a song! You get it all, in original factory carton, BRAND NEW, complete with 17 tubes, less power supply. Conversion Instructions Included. Shpg. wt. 25 lbs. **\$29.50**

PE-101C DYNAMOTOR for BC-645, has 12-24V input (easy to convert for 6V Battery operation) only **\$7.95**
UHF ANTENNA ASSEMBLY, for BC-645... **\$2.45**
Complete set of 10 Plugs for BC-645 **\$5.50**

CONTROL BOX for above... **\$2.25**
SHOCK MOUNT for above... **1.25**
CONVERSION BOOKLET. Instructions for most useful surplus rigs... **\$2.50**

HEADPHONES

Model	Description	Excellent Used	BRAND NEW
HS-23	High Impedance	\$2.25	\$4.35
HS-33	Low Impedance	1.99	4.65
HS-30	Low Imp. (featherwt.)	1.49	1.85
H-16/U	High Imp. (2 units)	2.75	7.95
CD-307A	Cords, with PL55 plug and JK26 Jack		.99



MOBILE TRANSCEIVER DYNAMOTOR

Special Buy! Output 625 Volts DC @ 225 Ma. Input 12 1/2 V @ 12.7 Amps, DC. Size 8x4 1/4x4 1/4". BRAND NEW... **\$10.95**
Excellent Used... **\$8.95**

OTHER DYNAMOTOR VALUES:

Type	Input	Output	Excellent Used	BRAND NEW
DM-64A	12V 5.1A	275V .150A		\$7.95
DM-40	14V 3.4A	172V .138A	1.95	3.95
DM-42A	14V 46A	515/1030 2/8 MA 215/260	8.95	12.95
DM-32A	28V 1.1A	250V .05A	2.95	5.95
DM-34D	12V 2.8A	220V .080A	4.25	5.50
DM-37	25.5V 9.2A	625V .225A	6.95	9.95
DM-28	28V	224V .07A	1.95	4.95
DM-53A	28V 1.4A	220V .080A	2.95	5.95
DM-33A	28V 5A	575V .16A		
	28V 7A	540V .25A	1.95	3.95
PE-103	6V	500V .160A		
	12V	500V .160A	19.50	34.50
PE-86	28V 1.25A	250V .060A	2.95	5.24

AIRCRAFT RADIO TRANSMITTER-RECEIVER RADIO SET SCR-AR-283.

Consists of: RECEIVER, 201 to 398 Kc and 2500 to 7850 Kc. TRANSMITTER, 2500 to 7700 Kc, for unmodulated, tone-modulated, or voice. Here's what you get, at this fantastically low price: Receiver complete with 6 tubes; transmitter complete with 4 tubes, Dynamotor for 24 V DC operation, 5 coil sets, 2 control boxes, antenna switching relay, operating manual. ALL BRAND NEW—and All Yours, for only **\$15.95**
Hurry—Limited Quantity!



AGFA ANSCO BUBBLE SEXTANT

Made for U. S. Armed Forces. Actually worth \$150 or more! Has illuminated averaging disc for nighttime use. Complete with carrying case, recording discs, flashlight with rheostat for using sextant at night. 2X telescope for faint stars, and Allen wrench. Only, **\$9.95**
Complete

SCR-522

FINEST 2-METER RIG!

Terrific buy! VHF Transmitter-Receiver, complete with all components, 100-156 Mc. 4 channels. Xtal-controlled, Amplitude modulated voice. They're going fast! Excellent condition.



SCR-522 Transmitter-Receiver, complete with all 18 tubes. **\$39.50**
COMBINATION. Special Receiver Only, with all tubes... **\$21.25**
Transmitter Only, with all tubes... **\$24.50**

LORAN APN-4

Fine Quality Navigational Equipment

Determine exact geographic position of your boat or plane! Complete, BRAND NEW installation consists of: 1D-6B/APN-4 Indicator; R-9B/APN-4 Receiver; PE-20B Inverter; Set of Plugs; Visor for Indicator; Operation manual; Brand New, Export packed. COMPLETE **\$129.50**

R-65/APN-9 LORAN Receiver-Indicator

Furnishes position data at greater distances from transmitting stations than is possible by any other method. Accurate to within 1% of distance from ground transmitters. Operates entirely by radio. Complete in one case. BRAND NEW export packed... **\$295.00**

BC1206-C BEACON RECEIVER

195 to 420 Kc, made by Satchel-Carlson. Works on 24-28 volts DC. 135 Kc IF. Complete with 5 tubes. Size 4" x 4" x 6". Wt. 4 lbs. BRAND NEW... **\$8.88**
Used, with tubes... **\$5.95**

BC-221 FREQ. METER CASE



Aluminum case for BC-221 or TS-164 Freq. Meters. With volt. reg. supply using VR105. 2 ballast tubes, relay, cable, etc. Inside front: 9 3/4" x 7 1/2" x 7 3/4". Inside rear: 2" deep. Shock-mounted.

BRAND NEW, (Add 50c for packing) **\$3.45**

Original Crystal for BC-221 **\$8.45**
1000 Kc BRAND NEW... **\$4.88**

CARDWELL TUNING CONDENSER for BC-221 Freq. Meter. Massive, precision construction, overall 4 x 3 x 3". 31 plates. Worm gear drive. BRAND NEW, special... **\$4.88**

COMPLETE OPERATING MANUAL for BC-221 Freq. Meter... **\$1.95**

2-VOLT "PACKAGE"

1-2V. 20 Amp. Hr. Willard Storage Battery... **\$2.45**
1-2V. 7 prong Synchronous Plug-in Vibrator... **1.49**
1-Quart Bottle Electrolyte (for 2 cells)... **1.45**
ALL BRAND NEW! Combination Price... **\$4.99**

Willard 6-Volt Midget Storage Battery 3 Amp. Hour. BRAND NEW. 3 5/8" x 1-13/16" x 2 3/8". Uses Standard Electrolyte... Only **\$2.22**

BC-442 ANTENNA RELAY UNIT

Wonderful Value! Consists of 3/4 amp 2 1/2" RF Ammeter (antenna current indicator), 0-10 scale Transmitter Receiver Switching relay, in aluminum case with associated components. BRAND NEW... **\$2.24**



WRITE FOR FREE CATALOG!

Please include 25% Deposit with order—Balance C.O.D. MINIMUM ORDER \$3.00. All Shipments F.O.B. Our Warehouse N.Y.C.

G & G Radio Supply Co.

Dept. N-3
51 Vesey St., New York 7, N. Y., CO 7-4605
Branch: 544 So. Broadway St., Dayton, Ohio

BC-946-B BROADCAST RECEIVER



520 to 1500 Kc broadcast band. 6 tubes: 3-12SK7, 12SR7, 12A6, 12K8. For dynamotor operation. Easily converted to 110 volt or 32 volt use. Two IF stages, 3-gang tuning cond. In sealed carton, with all tubes. BRAND NEW **\$19.95**

SCR-274 COMMAND EQUIPMENT

Type	Description	Used	Excellent BRAND NEW
BC-453	Receiver 190-550 Kc	\$9.95	\$11.95 \$14.95
BC-453	Receiver 3-6 Mc	7.19	8.25 9.95
BD-455	Receiver 6-9 Mc	.95	7.95 9.95
BC-456	Modulator	2.24	2.75 4.24
BC-457	Transmitter 4-5.3 Mc	7.95	11.95 12.95
BC-458	Transmitter 5-3.7 Mc	5.95	7.95 8.95
BC-459	Transmitter 7-3.1 Mc	7.95	8.95 11.95
BC-450	3-Band Control Box		1.45 1.95
BC-451	Transmitter Control Box		1.25 1.49
BC-696	Transmitter 3-4 Mc		14.75 19.50

ARC-5/R-28 RECEIVER

2 Meter superhet, 100 to 156 Mc in 4 xtal channels. Louvred alum. cabinet 7 3/8 x 4 7/8 x 14". Complete with 10 tubes and 4 xtals. Excel. Cond... **\$14.95**

ARC-5/T-23 TRANSMITTER

Companion for above, incl. 2-832A, 2-1625 tubes and 4 xtals... **\$22.50**

ARC-5 MARINE RECEIVER-TRANSMITTER

Navy Type Comm. Receiver 1.5 to 3 Mc BRAND NEW with 6 tubes... **\$16.95**
Navy Type Comm. Transmitter 2.1-3 Mc BRAND NEW with 4 tubes and Xtal... **\$12.45**



TS-100/AP OSCILLOSCOPE BRAND NEW (worth \$750)

OUR LOW PRICE **\$34.50**

Can be used with linear sweep or general purpose test scope. Cables included. Also used with circular sweep as precision range calibrator. PRF rate 300-1500 per sec. Trigger input 15V @ 100V per microsec. Trigger output 120V (+20V). Can be used to detect "jitter" in trigger divider circuits and modulator trigger pulse, also determining and adjusting division rate. Self-contained in metal case 8" x 12 1/2" x 16" deep. For 110V 50 to 1200 cycles AC. Demilitarized, NEW, with all tubes including crystals and C. R. Tube.

BENDIX DIRECTION FINDER

MN-26-C. 12-tube remote control Navigation Direction Finder and communications receiver. 150 to 1500 Kc in 3 bands. 28 V. DC input. Ideal for commercial navigation on boats and planes. Complete installation comprises:
MN-26-C Receiver complete with 12 tubes... **\$16.50**
MN-20-E Rotatable Loop... **\$4.25**
MN-52 Azimuth Control Box... **2.95**

MN26Y DIRECTION FINDER

150 to 7 Mc. Complete with tubes, motor; original manuals. BRAND NEW... **\$21.95**

MICROPHONES

Model	Description	Excellent Used	BRAND NEW
T-17	Carbon Hand Mike	\$5.45	\$7.95
T-30	Carbon Throat Mike	.33	.69
T-45	Navy Lip Mike		.99
RS-38	Navy Type	2.25	4.95
T-24	Carbon Mike		3.95

TG-34A CODE KEYS

Self-contained automatic unit, reproduces code practice signals recorded on paper tape. By use of built-in speaker, provides code-practice signals to one or more persons at speeds from 5 to 25 WPM.

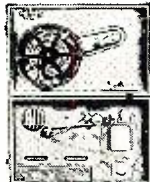

BRAND NEW, in original carton. **\$16.88**

REEL OF TAPE for above... **\$1.29**

ADAPTER



Write for Bull. 354B
TYPE 7B **\$2.25**
TYPE 8B **\$2.50**
TYPE 9B **\$2.75**
(ILLUSTRATED)
plus shipping chgs.

- Min. size for use in crowded spaces
 - RETMA color coded terminals
 - Uses (All above chassis)
1. Modify circuits for max. performance and testing without soldering or unsoldering.
 2. Break into any circuit for trouble shooting.
 3. Measure voltage, resistance and current in conjunction with standard instruments.

A. L. PRODUCTS CO., INC.

—311 Hickory St., Kearny, N. J.—

SCHEMATICS—CONVERSIONS FOR SURPLUS GEAR

NEW LIST DI! MANY ADDITIONS!

Send stamped, self addressed envelope for List D. Add 25c for chart explaining AN nomenclature. DO IT TODAY!

R. E. BOX 1220
GOODHEART BEVERLY HILLS, CAL.

NOW IN STOCK at ELMAR ELECTRONICS

140-11 Street Oakland 7, Calif.

EICO

COLOR & BLACK & WHITE

5" — 5 MC SCOPE

KIT \$79.95 Wired \$129.50



#460

ELECTRONICS

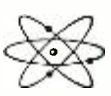

Prepare for ENGINEERING DEGREE unlimited opportunities in 27 MONTHS

the Electronic Age! Earn your B.S. degree in 27 months at Indiana Technical College. Intensive, specialized course. Comprehensive training in math and electrical engineering, advanced radio theory and design, television, electronics. Most important: Low rates. Also B.S. DEGREE IN 27 MONTHS in Aeronautical, Chemical, Civil, Electrical and Mechanical Engineering. G.I. approved. Enter March, June, September, December. Earn part of your expenses in Fort Wayne while studying. Write for catalog.

INDIANA TECHNICAL COLLEGE

936 E. Washington Blvd., Fort Wayne 2, Indiana Please send me free information on B.S. ENGINEERING DEGREE IN 27 MONTHS as checked.

- Electronics
- Chemical
- Aeronautical
- Civil
- Mechanical
- Electrical

Name

Address

HEINEMAN CIRCUIT BREAKER—Cat. AM12M7

ea. 2 for 2.50

SMALL PIONEER GENOMOTORS
Ideal for Amateur or Commercial Service 5.5 to 6 volt DC input—output 400 volts at 175 MA cont. or 275 MA intermittent duty. Comes complete with A & B filters, RF hash filter & internal cooling fan. each \$19.95
Same as above—with 11.5 to 12 volt DC input. each \$12.95

1" MINIATURE METER
High quality meter made by International Instrument Co. Mounts in a 1" hole like a pilot light. Basic movement 0-10 mills. Can be shunted to any millamp range. \$2.95
0-10 Mill. Special \$2.95

WESTON 1 1/2" MINIATURE METER
MODEL 1011—A fine meter suitable for compact grid dipper, field strength, many other applications. 0-500 Microamps. \$4.50
0-1 Milliamp \$3.95

ADVANCE ANTENNA RELAY
1000 series, silver plated contacts, D.P.D.T.—has third set of contacts normally open. Insulated throughout with Isolantite. Operates on 110 V. Volts AC 60 cycles. BRAND NEW. \$2.95
2 for \$5.50

ALLIED 110 VAC 60 cy RELAY, 4 Pole D.T. Con-
tacts pure silver. 15 amp. \$1.75

NATIONAL EMC 250 VARIABLE COND.
Steatite insulation 250 MMF. 1.25 ea.

G. E. RELAY CONTROL
(Ideal for Model Controls, Etc.)
Contains a sigma midget 8,000 Ohm, relay (trips at less than 2 Ma), high impedance choke, bi-metal strip, neon pilot and other useful parts. The sensitive relay alone is worth much more than the total low price of. . . \$1.25 ea. 10 for \$9.90

SENSITIVE RELAY
5000 ohm coil operates on 1 ma, adjustable contacts, adjustable armature tension. SPDT-Bakelite base. Ideal for model work. Can also be used on AC. Draws \$1.75
4 mill AC @ 110 V. Ideal for burglar alarm \$7.50

WESTON MODEL 1021 H. S. 2 1/2" meter with a basic 0-1 mill movement. \$2.95
SPECIAL

OIL CONDENSER SPECIALS BRAND NEW

25 MFD 350 VDC \$1.25	1 MFD 3000 VDC 1.85
2 MFD 600 VDC .50	4 MFD 3000 VDC 6.95
4 MFD 600 VDC .75	5 MFD 3600 VDC 2.25
8 MFD 600 VDC .95	4 MFD 4000 VDC 7.95
10 MFD 600 VDC 1.19	5 MFD 330 AC .95
2 MFD 1000 VDC 1.25	20 MFD 330 AC 2.50
4 MFD 1000 VDC 1.25	8 MFD 660 AC 1.95
8 MFD 1000 VDC 1.50	1 MFD 10KV 22.50
6 MFD 1500 VDC 1.95	2 MFD 10KV 39.95
10 MFD 1400 VDC 2.50	1 MFD 15KV 39.95
1 MFD 2000 VDC .95	
2 MFD 2000 VDC \$1.50	
4 MFD 2000 VDC 3.50	

NEW PANEL METERS

G.E., WESTINGHOUSE, W.E., SIMPSON, etc.	
2" METERS	0-150 MA R.F.
0-100 Microamp \$5.95	Int. Thermo. 3.49
100-0-100 Microamp	0-4 Amps R.F. 3.49
0-40 Volts DC. 2.95	3" METERS
0-1 Mill 3.25	0-11 Milli 3.95
0-75 Mill 2.95	15-0-15 Milli 3.95
0-200 Mill AC 2.95	amps (2000 DC) 2.50
10-0-10 Amps DC 2.49	0-50 Milliamp (1 Mill Basic) 3.95
0-15 Volts AC 2.95	0-300 Milliamp 3.95
0-300 Volt AC 3.95	0-500 Milliamps 3.95
- 10 to + 60B 3.45	0-15 Amps DC. 2.95

SHIELDED CHOKES
12 Henry 150 Ma. \$1.65
8 Henry 200 Ma. 1.95
Thordarson 15 Henry 200 Ma. 2.25
6 Henry 300 Ma. 2.95

HIGH VOLTAGE TRANS. MICAS
G1 .00015 10KV. 2.75
G1 .0002 6KV. 2.50
G2 .00015 10KV. 3.75
G3 .002 15KV. 25.50
G4 .00015 30KV. 28.50
G4 .0025 25KV. 42.50

WESTINGHOUSE R.F. meter 2 1/2" bakelite case.
Int. thermo. Scale linear from 1-9 amps. 0-9 amps. \$2.95 ea.
2 for \$5.50

WESTON MODEL 506. 2 1/2" Sq. bakelite case.
An outstanding value. 0-40 Volts \$2.95
2 for \$5.50

Read 'n' Save Bargains

500 MMF CERAMIC CONDENSERS. 10 for \$5.50
1-9 MMF Var. Cond. mixtures incl.95
SANGAMO F2L .001 5000 VOLTS WORKING.75
TRANSMITTING MICA CONDENSER75
25 WIRE WOUNDS RESISTORS 1/4 WATT 1.95
.01 MMF 1000 VDC MICAS 5 for .95
.0004 2500 VDC MICAS 5 for .95
.025 600 V. MICAS 5 for .95
100,000 OHM, 100 WATT RESIST.45
GLOBAR 9 OHM 100 WATT (non-inductive) 6 for 1.45
OHMITE WIRE WOUND (non-inductive) 18 OHM 100 WATT 59c ea. 5 for 2.50
1 MFD Oil Condenser 400 VDC 10' for 2.00

All merchandise sold on a 10 day money back guarantee basis

Min. Order \$3.00—25% with Order—F.O.B. New York

PEAK

ELECTRONICS COMPANY
66 W. Broadway, New York 7, N.Y., WO-2-5439

Home Tape Recorder

(Continued from page 41)

then be made on earphones inserted into a monitor jack or *via* a sound system connected to the output. (If the sound system used for monitoring is also used for feeding material to the recorder, usually *via* a tape output jack in the preamplifier, there is a feedback problem inasmuch as the signal supplied to the recorder is almost simultaneously fed by the recorder to the preamplifier. The means of eliminating this problem is to connect the recorder in series between the preamplifier stage feeding the tape recorder and following preamplifier stages. Then the A-B switch is used to feed either the preamplifier signal or the tape playback signal to the monitor and output jacks.)

Safety Interlock. A prized tape can come to grief if the tape recorder is unintentionally put into record position. The machine should contain a safety interlock that prevents putting the machine into record position unless the interlock button is simultaneously depressed. In addition, it is highly desirable that a warning light go on when the machine is in record position.

Tape Handling. Specifications usually state how rapidly the tape transport starts and stops and winds in the forward and reverse directions. Very important—but something that the specifications do not mention and only observation will indicate—is how smoothly these functions are performed so that tape is not stretched, broken, or spilled.

For home purposes it is adequate that a machine come up to full operating speed or to a complete stop within a second. Some of the professional machines do so in .1 second. Rewind or forward wind should not take more than 90 seconds for 1200 feet, which is the regular length of a 7-inch reel. The professional units require as little as 30 seconds. However, the longer wind time of the less expensive recorders, although an inconvenience, is in some ways a blessing. To the extent that the wind operation is not perfectly smooth, there is a tendency to jerk and thereby stretch the tape. But the slower the winding speed, the smaller this tendency. In some instances where the utmost of recording perfection is sought, a tape is rewound at the same speed at which it was recorded by reversing the reels and putting the machine in playback position.

A few professional machines provide continuously variable wind speed. This is useful not only for purposes of smooth tape handling but also to permit easy location of particular passages when editing.

Tape Lift. Good tape heads are expensive, costing from \$15 upwards. In some home tape recorders, a principal source of wear is the friction generated by rapid passage of the tape across the heads during rewind or forward wind.

A well-designed mechanism should automatically space the tape away from the heads during the wind operation. In some professional machines, however, the spacing is kept slight enough to permit signal pickup (chiefly low frequencies) so that a desired portion of the tape can be identified.

Automatic Stop. Should the tape break or run out while a recorder is left unattended, allowing a reel of tape to go whipping around at high speed, the room will soon be littered with confetti. This unhappy consequence can be avoided if the mechanism provides for automatic stop when tape travel is interrupted, a safeguard usually found only in professional machines.

Inputs. The minimum requirement, met almost without exception in home tape recorders, is that there be a "line" input for high-level sources such as a radio tuner, crystal phonograph, or audio preamplifier, which produce a signal on the order of a volt or two; and an input for a microphone, which produces a signal of only a few millivolts. In the low price machines these are customarily high-impedance inputs and are both governed by the same volume control. Some of the better home machines, however, also provide a low-impedance input to accommodate low-impedance microphones, which are less sensitive to hum pickup and permit long cable runs without appreciable attenuation of high frequencies. Also, some of the expensive machines provide mixing facilities, which permit the line and microphone inputs to be used simultaneously, with individual level controls for each. A feature that appears in some home recorders is an input which provides the gain and equalization required by a magnetic phonograph pickup.

Outputs. Even though a tape recorder contains a power amplifier and speaker, it should provide an output jack for feeding external sound systems. This jack should be connected to a stage *prior* to the internal power amplifier. Some tape recorders provide an additional output jack for feeding an external speaker from the recorder's amplifier. Although this jack can also be used to supply an external amplifier, the results obtained are not usually as good as from a jack preceding the internal power amplifier. Some machines provide only the external speaker jack, which, as just indicated, is not apt to provide the best obtainable results when feeding an external sound system.

Tape recorders with self-contained sound systems customarily have tone controls. So do some of the home machines without an amplifier and speaker. In either case, the output jack for feeding an external amplifier and speaker should *precede* the recorder's tone controls, unless these are part of the equalization circuits required for flat response. In the latter case, the controls should be accurately marked for the settings which most nearly produce flat response.

Some of the home tape recorders

that have combination record-playback heads provide a monitor output jack, so that the signal at some stage in the machine can be monitored by headphones or an external sound system. While this provides some indication that the recording signal is getting through, it does not provide complete assurance that recording is proceeding satisfactorily, as in the case of a machine with three heads, where playback can be immediately monitored. However, sometimes other uses can be found for the monitor jack, such as attaching a more satisfactory record level indicator in the form of a decibel meter.

Equalization. Machines operating at 15 ips almost universally use NARTB equalization, which provides a specific bass boost characteristic in playback. Inasmuch as record and playback equalization are complementary, the playback curve implicitly defines the record characteristic as well.¹ In the case of machines operating at other speeds, there is no equalization standard. However, a number of 7.5 ips recorders are using the NARTB 15 ips standard. A few are using the NARTB curve modified one octave down; thus the 3 db bass boost point occurs at 1590 cps, instead of at 3180 cps as specified by NARTB. Still other recorders are using different equalization. In view of the considerable extent to which NARTB equalization is being used by 7.5 ips machines, and especially in view of the fact that most 7.5 ips recorded tapes employ this equalization, it is desirable that home tape recorders designed to operate at this speed, whatever over-all equalization they use, should provide means for switching in NARTB equalization for playback.

It was previously indicated that some tape recorders depend upon variable tone controls to supply some of the equalization required for flat response. To maximize signal-to-noise ratio, most or all the necessary treble equalization should be introduced in record rather than playback. Treble boost in playback accentuates not only the higher frequencies but also tape hiss and other forms of noise that lie predominantly in the upper register. Consequently, a tape recorder that depends upon substantial playback treble boost, supplied by a tone control circuit, in order to achieve flat response will have a less satisfactory signal-to-noise ratio than if treble boost occurred in record.

Noise Cancellation. Depending upon types of circuits used, there are various methods of cancelling out noise introduced during recording. Lack of symmetry in the bias waveform is a principal cause of noise. Thus, one method of cancellation takes the form of balancing the two halves of a push-pull oscillator circuit.

Erasures. Specifications say virtually nothing about erasure. However, it is a fact that many home tape recorders

Electron Tubes With Energy Like The Sun

SOLAR ELECTRONICS

To insure only top quality merchandise Solar Electronics "set tests" each electron tube in powerfully loaded chassis.

Here is Our New Guarantee Policy: Money back within 5 days of receipt of merchandise PLUS 5 year free factory replacement. ALL TUBES ARE CODED BY MONTH AND YEAR!

FREE BONUS OFFER!



Model 625K
A terrific Eico Tube Tester or TV FM Sweep Generator FREE when you buy \$200 worth of receiving tubes or more within 60 days at Solar. Tester or generator may be bought outright from Solar for \$33.50.

ANTENNA SPECIALS

List **\$845**
\$15!
Complete Outdoor ALL CHANNEL CONICAL

Includes: 8 element antenna with crossbar, 5 ft. seamless aluminum mast chimney mount or 7 ft wall bracket, 8 stand offs, 50 ft. of 300 ohm wire. State your need!

NEW INDOOR ANTENNA

Brings in UHF and VHF. Use on Top of TV. List \$9.95

Your Price **\$375**

Used TV SETS

Picture Tube Guaranteed To Work!
10" Set
Table Model \$17.50
Console \$20.00
12" Set
Table Model \$22.50
Console \$25.00
14" Set
Table Model \$27.50
Console \$30.00
16" Set
Table Model \$32.50
Console \$35.00
17" Set
Table Model \$36.50
Console \$39.00
19", 20", 21" and 24" Sets—prices on request.

Famous Make Test Equipment!

TUBE TESTER KIT
In carrying case **\$3325**
Factory wired, \$44.95

VACUUM TUBE VOLTMETER KIT **\$2495**
Factory wired, \$37.50

FLYBACK TRANSFORMER and YOKE TESTER KIT **\$2175**
Factory wired, \$31.75

Test Equipment Factory Guaranteed For One Year!
ALL PARTS SHIPPED
F.O.B. HARRISON, N. J.

EASY TERMS!
We pay all postage or freight in USA. Territories and APOs. 25c handling on orders less than \$5. Please send 25% deposit with C.O.D.'s. Remember! Your money cheerfully refunded within 5 days if you are not completely satisfied.

SEND FOR FREE TUBE LISTINGS

PICTURE TUBE SPECIALS!

Brand New—RCA Licensed—One Year Guarantee

Type	Price	16CP4	17BP4	\$19.85
10BP4		or A	17CP4	\$20.85
or A	\$11.25	16DP4	17GP4	\$21.25
10FP4	\$14.95	or A	19AP4	\$23.95
12LP4		16EP4	19DP4	
or A	\$13.95	16GP4	or A	\$23.50
12QP4	\$13.95	16HP4	19FP4	\$24.25
12JP4	\$13.25	or A	20CP4	
12UP4	\$14.95	16JP4	or A	\$24.50
14BP4		or A	20DP4	
or A	\$15.95	16LP4	or A	\$24.50
14CP4	\$15.95	or A	21AP4	\$27.95
15DP4 (for Du-		16KP4	21EP4A	\$27.50
mont)	\$17.95	16RP4	21FP4	\$28.25
16AP4		16ZP4	21YP4	\$28.25
or A	\$18.95	or A	24AP4	\$44.95

All Picture Tubes Shipped FOB Harrison, N. J.

BIGGEST VALUES! BIGGEST SELECTIONS!

Partial List Only!

Type	Price	Type	Price	Type	Price	Type	Price
0A2	.67	6A7	.55	6SH7	.43	12K7	.49
0D3/VR150	.90	6AB4	.45	6SJ7	.43	12Q7	.44
0Z4	.44	6AC7	.46	6SK7	.41	12SA7	.43
1A4P	.30	6AF4	.50	6SL7GT	.53	12SG7	.59
1A7GT	.45	6AG5	.85	6SN7GT	.53	12SH7	.57
1A2	.65	6AG7	.75	6SQ7	.37	12SJ7	.44
1B3GT	.63	6AH4GT	.65	6S7	.43	12SK7	.43
1B4P	.88	6AH6	.65	6T4	.69	12SL7GT	.59
1CSGT	.45	6AK5	.57	6T8	.65	12SN7GT	.53
1D5GP	.40	6AL5	.38	6U8	.73	12SQ7	.35
1E7GT	.40	6AN4	1.25	6Y3	.77	12VG7	.44
1E7GT	.40	6AN8	.99	6V6GT	.44	12X4	.35
1H4G	.35	6AQ5	.45	6W4GT	.38	14A5	.90
1HS7	.45	6AS6	1.50	6W6GT	.55	14A7	.44
1L4	.47	6AT6	.36	6X4	.35	14B6	.39
1L6	.53	6AU4GT	.70	6X5GT	.35	14E6	.59
1LA4	.55	6AU5GT	.60	6X8	.75	14E7	.59
1LA6	.55	6AU6	.40	6Y6G	.49	14F7	.59
1LB4	.55	6AU7	.05	7A4	.44	14F8	.69
1LC6	.51	6AV5GT	.65	7A5	.53	14N7	.69
1LH4	.55	6AV6	.36	7A6	.44	19B6G6	1.10
1LN5	.51	6AX4GT	.65	7A7	.44	19T8	.64
1NSGT	.53	6AX5GT	.59	7B4	.43	24A	.35
1R5	.58	6B8	.75	7B5	.40	25BQ6GT	.75
1S5	.41	6BA6	.45	7B6	.44	25C6	1.10
1T4	.49	6BA7	.55	7B7	.44	25L6GT	.45
1T5GT	.57	6BC5	.50	7B8	.44	25W4GT	.42
1U4	.55	6BE6	.46	7C4	.44	25Z5	.39
1U5	.41	6BF5	.42	7C5	.44	25Z6GT	.35
1V2	.63	6BG6G	1.10	7C6	.44	26	.48
1X2	.65	6BH6	.52	7E5	.59	27	.29
2A7	.50	6BJ6	.49	7F7	.59	32L7GT	.53
2X2A	.55	6BK5	.65	7F8	.69	35	.32
3A4	.55	6BK7	.75	7H7	.69	35/51	.33
3A5	.55	6BL7GT	.69	7J7	.69	35A5	.44
3AL5	.48	6BN6	.60	7K7	.69	35B5	.48
3AU6	.48	6BQ6GT	.75	7N7	.54	35C5	.48
3BC5	.56	6BQ7	.60	7X7	.69	35L6GT	.45
3BN6	.65	6BY5G	.60	7Y4	.39	35W4	.35
3CB6	.56	6BZ7	.60	7Z4	.39	35Y4	.35
3Q4	.45	6C4	.35	12A76	.38	35Z5GT	.35
3Q5GT	.55	6CB6	.50	12A77	.65	37	.30
354	.52	6CD6G	1.10	12AUG	.42	39/44	.35
3V4	.52	6CU6	.90	12AU7	.52	50A5	.44
4BQ7	.92	6D6	.45	12AV6	.38	50B5	.48
4BZ7	.97	6F6	.40	12AV7	.73	50C5	.48
5A05	.52	6H6	.42	12AX4GT	.67	50L6GT	.45
5J6	.60	6J4	1.50	12AX7	.69	75	.40
5U4G	.45	6J5	.38	12AZ7	.65	76	.40
5U8	.68	6J6	.50	12B4	.65	77	.40
5V4G	.56	6K6GT	.36	12BA6	.45	78	.40
5V6GT	.52	6L6	.65	12BA7	.59	80	.35
5X8	.78	658GT	.74	12BF5	.45	84/624	.41
5Y3	.29	6SA7	.44	12B7	.59	117L7GT	1.39
5Y4G	.35	6SC7	.50	12BY7	.64	117N7GT	1.29
5Z3	.40	6SF5	.60	12CU6	1.09	117P7GT	1.29

FREE INTRODUCTORY GIFT
Mention This Ad.
With every order of \$15 or more —one 6SN7GT, one 6W4GT, 5 assorted resistors, 5 assorted attractively colored tube cartons; or with every order of \$30 or more —1 RCA Cheater Cord, plus 5 assorted Resistors, one 6SN7GT, one 6W4GT, one 6K6GT and Vid-aire 2 Set Coupler.

TO QUANTITY USERS!
Your initial order of \$150 or more entitles you to our special 10% discount or free Deluxe "60" Remington Razor. State your choice. This offer not good if you are taking advantage of free tube tester or generator offered elsewhere in this ad.

SOLAR ELECTRONICS

Post Office Square Harrison, N. J. ESsex 4-5300

¹Burstein, Herman: "Tape Recording—Equalization," Radio & Television News, January 1956.



Lektron's SPRING DOLLAR SALE!

PLUS—ANY ITEM IN THIS AD FREE WITH EVERY \$10 ORDER!

- 12 AC-DC LINE CORDS. POSJ type, 2 cond., #18 stranded. Rubber backed w/ molded plug. Wt. 1 lb. \$1 Reg. \$2.50.
- 5 ROLLS TAPE. Guaranteed fresh. Cellophane wrapped. Friction plastic, rubbers. Wt. 1 lb. Reg. \$2.50.
- 30 MINIATURE BULBS. Ass'd. standard screw & bayonet types. 1.1 thru 6 V. Wt. 1/2 lb. Reg. \$1 \$4.00.
- 100 STEATITE COIL FORMS. Builders' special! Many sizes, styles. Some worth \$2 ea. Plus 30 ass'd. iron slugs FREE. Wt. 2 lbs. Reg. \$15. \$1
- 125 CARBON RESISTORS. 30 values, 100 ohms to 1 meg. 1/2, 1 & 2 W. Uninsulated. Wt. 1 lb. Reg. \$21. \$1
- 10 VOLUME CONTROLS. Ass'd. values for radio, TV, lab. 10 ohms to 1 meg. Wt. 2 lbs. Reg. \$1 \$9.00.
- 13-PC. TWIST DRILL KIT. 1/16 thru 1/4" to 1/2" chuck. Fine tempered steel. Plastic case. Wt. 1 lb. Reg. \$3.00. \$1
- G-E PRE-AMP KIT. Chassis, condensers, resistors, wire, socket, schematic. Uses 8SC7 (comes less tube). Wt. 1 lb. Reg. \$4.50. \$1
- 150 RADIO PARTS! Large stock of coils, ceramics, paper, moulded & mica condensers, resistors. Wt. 1 lb. Reg. \$30. \$1
- 25 TUBE SOCKETS. 4 to 14 pins, subminiatures, miniature, octal, 15 types. Mica & ceramic. tool Wt. 1 lb. Reg. \$9. \$1
- 3 LBS. HOOKUP WIRE. Repeating 2 self-out. Hundreds of pre-cut lengths in ass'd. sizes, color. Stranded. lengths up to 18". Reg. \$9. \$1
- 60 MICA CONDENSERS. Postage stamp type. 25 values: .00001 to .01 mf. Many silver, 5%, tool Wt. 1/2 lb. Reg. \$17. \$1
- 20 POWER RESISTORS. Wirewound, candohm & tubular. 20 values to 10,000 ohms; 5 to 50 w. Wt. 1 lb. Reg. \$12.00. \$1
- 60 CARBON RESISTORS. Insulated. 35 values; 15 ohms to 10 megs; 1/2, 1 & 2 w. Many 1 & 2%. Wt. 1/2 lb. Reg. \$18. \$1
- 50 CERAMIC CONDENSERS. Cartwheel, disc, button, standoff & tubular types. 25 values; 5mmf to .01mf. Duals; tool Wt. 1/2 lb. Reg. \$18. \$1
- 10 ELECTROLYTICS. EP type. 2 cond., #8 to 1000 mf up to 450 V. Multiple sections. Top. Some \$2.50 each. Wt. 2 lbs. Reg. \$1 \$18.
- 50 INDUCTORS. Wide variety—slug-tuned; RF, ant., peaking coils; RF & xmtg. chokes. Shop must! Wt. 1 lb. Reg. \$21. \$1
- 50 KNOBS. Instrument, radio, TV & appliance types: knurled, skirted, push-on, pointer types. Some 50c ea. Wt. 1 lb. Reg. \$1 \$12.
- 3 SELENIUM RECTIFIERS. One each 24 VDC @ 5A; 12 VDC @ .25A; one meter or instrument type. Wt. 1 lb. Reg. \$15. \$1
- 8-PC. POCKET TOOL SET. 30 Phillips, 2 screwdrivers, chisel, awl, tackliner, plastic handle. Wt. 1 lb. Reg. \$3.50 value. \$1
- 60 TUBULAR CONDENSERS. Ass'd. values: 1 mf. to .00035 to 1 mf. to 1600 V. Oils & mouldeds; tool Wt. 2 lbs. Reg. \$1 \$10.
- 1000 PCS. SPAGHETTI. Ass'd. sizes, colors, insulation. Lengths to 47". 7/16, 1/2, 3/4, 1, 1 1/2, 2, 3, 4, 5, 6, 8, 10, 12, 15, 18, 24, 30, 36, 42, 48, 54, 60, 72, 84, 96, 108, 120, 144, 180, 216, 270, 324, 360, 432, 480, 540, 600, 648, 720, 792, 864, 936, 1008, 1080, 1152, 1224, 1296, 1368, 1440, 1512, 1584, 1656, 1728, 1800, 1872, 1944, 2016, 2088, 2160, 2232, 2304, 2376, 2448, 2520, 2592, 2664, 2736, 2808, 2880, 2952, 3024, 3096, 3168, 3240, 3312, 3384, 3456, 3528, 3600, 3672, 3744, 3816, 3888, 3960, 4032, 4104, 4176, 4248, 4320, 4392, 4464, 4536, 4608, 4680, 4752, 4824, 4896, 4968, 5040, 5112, 5184, 5256, 5328, 5400, 5472, 5544, 5616, 5688, 5760, 5832, 5904, 5976, 6048, 6120, 6192, 6264, 6336, 6408, 6480, 6552, 6624, 6696, 6768, 6840, 6912, 6984, 7056, 7128, 7200, 7272, 7344, 7416, 7488, 7560, 7632, 7704, 7776, 7848, 7920, 7992, 8064, 8136, 8208, 8280, 8352, 8424, 8496, 8568, 8640, 8712, 8784, 8856, 8928, 9000, 9072, 9144, 9216, 9288, 9360, 9432, 9504, 9576, 9648, 9720, 9792, 9864, 9936, 10008, 10080, 10152, 10224, 10296, 10368, 10440, 10512, 10584, 10656, 10728, 10800, 10872, 10944, 11016, 11088, 11160, 11232, 11304, 11376, 11448, 11520, 11592, 11664, 11736, 11808, 11880, 11952, 12024, 12096, 12168, 12240, 12312, 12384, 12456, 12528, 12600, 12672, 12744, 12816, 12888, 12960, 13032, 13104, 13176, 13248, 13320, 13392, 13464, 13536, 13608, 13680, 13752, 13824, 13896, 13968, 14040, 14112, 14184, 14256, 14328, 14400, 14472, 14544, 14616, 14688, 14760, 14832, 14904, 14976, 15048, 15120, 15192, 15264, 15336, 15408, 15480, 15552, 15624, 15696, 15768, 15840, 15912, 15984, 16056, 16128, 16200, 16272, 16344, 16416, 16488, 16560, 16632, 16704, 16776, 16848, 16920, 16992, 17064, 17136, 17208, 17280, 17352, 17424, 17496, 17568, 17640, 17712, 17784, 17856, 17928, 18000, 18072, 18144, 18216, 18288, 18360, 18432, 18504, 18576, 18648, 18720, 18792, 18864, 18936, 19008, 19080, 19152, 19224, 19296, 19368, 19440, 19512, 19584, 19656, 19728, 19800, 19872, 19944, 20016, 20088, 20160, 20232, 20304, 20376, 20448, 20520, 20592, 20664, 20736, 20808, 20880, 20952, 21024, 21096, 21168, 21240, 21312, 21384, 21456, 21528, 21600, 21672, 21744, 21816, 21888, 21960, 22032, 22104, 22176, 22248, 22320, 22392, 22464, 22536, 22608, 22680, 22752, 22824, 22896, 22968, 23040, 23112, 23184, 23256, 23328, 23400, 23472, 23544, 23616, 23688, 23760, 23832, 23904, 23976, 24048, 24120, 24192, 24264, 24336, 24408, 24480, 24552, 24624, 24696, 24768, 24840, 24912, 24984, 25056, 25128, 25200, 25272, 25344, 25416, 25488, 25560, 25632, 25704, 25776, 25848, 25920, 25992, 26064, 26136, 26208, 26280, 26352, 26424, 26496, 26568, 26640, 26712, 26784, 26856, 26928, 27000, 27072, 27144, 27216, 27288, 27360, 27432, 27504, 27576, 27648, 27720, 27792, 27864, 27936, 28008, 28080, 28152, 28224, 28296, 28368, 28440, 28512, 28584, 28656, 28728, 28800, 28872, 28944, 29016, 29088, 29160, 29232, 29304, 29376, 29448, 29520, 29592, 29664, 29736, 29808, 29880, 29952, 30024, 30096, 30168, 30240, 30312, 30384, 30456, 30528, 30600, 30672, 30744, 30816, 30888, 30960, 31032, 31104, 31176, 31248, 31320, 31392, 31464, 31536, 31608, 31680, 31752, 31824, 31896, 31968, 32040, 32112, 32184, 32256, 32328, 32400, 32472, 32544, 32616, 32688, 32760, 32832, 32904, 32976, 33048, 33120, 33192, 33264, 33336, 33408, 33480, 33552, 33624, 33696, 33768, 33840, 33912, 33984, 34056, 34128, 34200, 34272, 34344, 34416, 34488, 34560, 34632, 34704, 34776, 34848, 34920, 34992, 35064, 35136, 35208, 35280, 35352, 35424, 35496, 35568, 35640, 35712, 35784, 35856, 35928, 36000, 36072, 36144, 36216, 36288, 36360, 36432, 36504, 36576, 36648, 36720, 36792, 36864, 36936, 37008, 37080, 37152, 37224, 37296, 37368, 37440, 37512, 37584, 37656, 37728, 37800, 37872, 37944, 38016, 38088, 38160, 38232, 38304, 38376, 38448, 38520, 38592, 38664, 38736, 38808, 38880, 38952, 39024, 39096, 39168, 39240, 39312, 39384, 39456, 39528, 39600, 39672, 39744, 39816, 39888, 39960, 40032, 40104, 40176, 40248, 40320, 40392, 40464, 40536, 40608, 40680, 40752, 40824, 40896, 40968, 41040, 41112, 41184, 41256, 41328, 41400, 41472, 41544, 41616, 41688, 41760, 41832, 41904, 41976, 42048, 42120, 42192, 42264, 42336, 42408, 42480, 42552, 42624, 42696, 42768, 42840, 42912, 42984, 43056, 43128, 43200, 43272, 43344, 43416, 43488, 43560, 43632, 43704, 43776, 43848, 43920, 43992, 44064, 44136, 44208, 44280, 44352, 44424, 44496, 44568, 44640, 44712, 44784, 44856, 44928, 45000, 45072, 45144, 45216, 45288, 45360, 45432, 45504, 45576, 45648, 45720, 45792, 45864, 45936, 46008, 46080, 46152, 46224, 46296, 46368, 46440, 46512, 46584, 46656, 46728, 46800, 46872, 46944, 47016, 47088, 47160, 47232, 47304, 47376, 47448, 47520, 47592, 47664, 47736, 47808, 47880, 47952, 48024, 48096, 48168, 48240, 48312, 48384, 48456, 48528, 48600, 48672, 48744, 48816, 48888, 48960, 49032, 49104, 49176, 49248, 49320, 49392, 49464, 49536, 49608, 49680, 49752, 49824, 49896, 49968, 50040, 50112, 50184, 50256, 50328, 50400, 50472, 50544, 50616, 50688, 50760, 50832, 50904, 50976, 51048, 51120, 51192, 51264, 51336, 51408, 51480, 51552, 51624, 51696, 51768, 51840, 51912, 51984, 52056, 52128, 52200, 52272, 52344, 52416, 52488, 52560, 52632, 52704, 52776, 52848, 52920, 52992, 53064, 53136, 53208, 53280, 53352, 53424, 53496, 53568, 53640, 53712, 53784, 53856, 53928, 54000, 54072, 54144, 54216, 54288, 54360, 54432, 54504, 54576, 54648, 54720, 54792, 54864, 54936, 55008, 55080, 55152, 55224, 55296, 55368, 55440, 55512, 55584, 55656, 55728, 55800, 55872, 55944, 56016, 56088, 56160, 56232, 56304, 56376, 56448, 56520, 56592, 56664, 56736, 56808, 56880, 56952, 57024, 57096, 57168, 57240, 57312, 57384, 57456, 57528, 57600, 57672, 57744, 57816, 57888, 57960, 58032, 58104, 58176, 58248, 58320, 58392, 58464, 58536, 58608, 58680, 58752, 58824, 58896, 58968, 59040, 59112, 59184, 59256, 59328, 59400, 59472, 59544, 59616, 59688, 59760, 59832, 59904, 59976, 60048, 60120, 60192, 60264, 60336, 60408, 60480, 60552, 60624, 60696, 60768, 60840, 60912, 60984, 61056, 61128, 61200, 61272, 61344, 61416, 61488, 61560, 61632, 61704, 61776, 61848, 61920, 61992, 62064, 62136, 62208, 62280, 62352, 62424, 62496, 62568, 62640, 62712, 62784, 62856, 62928, 63000, 63072, 63144, 63216, 63288, 63360, 63432, 63504, 63576, 63648, 63720, 63792, 63864, 63936, 64008, 64080, 64152, 64224, 64296, 64368, 64440, 64512, 64584, 64656, 64728, 64800, 64872, 64944, 65016, 65088, 65160, 65232, 65304, 65376, 65448, 65520, 65592, 65664, 65736, 65808, 65880, 65952, 66024, 66096, 66168, 66240, 66312, 66384, 66456, 66528, 66600, 66672, 66744, 66816, 66888, 66960, 67032, 67104, 67176, 67248, 67320, 67392, 67464, 67536, 67608, 67680, 67752, 67824, 67896, 67968, 68040, 68112, 68184, 68256, 68328, 68400, 68472, 68544, 68616, 68688, 68760, 68832, 68904, 68976, 69048, 69120, 69192, 69264, 69336, 69408, 69480, 69552, 69624, 69696, 69768, 69840, 69912, 69984, 70056, 70128, 70200, 70272, 70344, 70416, 70488, 70560, 70632, 70704, 70776, 70848, 70920, 70992, 71064, 71136, 71208, 71280, 71352, 71424, 71496, 71568, 71640, 71712, 71784, 71856, 71928, 72000, 72072, 72144, 72216, 72288, 72360, 72432, 72504, 72576, 72648, 72720, 72792, 72864, 72936, 73008, 73080, 73152, 73224, 73296, 73368, 73440, 73512, 73584, 73656, 73728, 73800, 73872, 73944, 74016, 74088, 74160, 74232, 74304, 74376, 74448, 74520, 74592, 74664, 74736, 74808, 74880, 74952, 75024, 75096, 75168, 75240, 75312, 75384, 75456, 75528, 75600, 75672, 75744, 75816, 75888, 75960, 76032, 76104, 76176, 76248, 76320, 76392, 76464, 76536, 76608, 76680, 76752, 76824, 76896, 76968, 77040, 77112, 77184, 77256, 77328, 77400, 77472, 77544, 77616, 77688, 77760, 77832, 77904, 77976, 78048, 78120, 78192, 78264, 78336, 78408, 78480, 78552, 78624, 78696, 78768, 78840, 78912, 78984, 79056, 79128, 79200, 79272, 79344, 79416, 79488, 79560, 79632, 79704, 79776, 79848, 79920, 79992, 80064, 80136, 80208, 80280, 80352, 80424, 80496, 80568, 80640, 80712, 80784, 80856, 80928, 81000, 81072, 81144, 81216, 81288, 81360, 81432, 81504, 81576, 81648, 81720, 81792, 81864, 81936, 82008, 82080, 82152, 82224, 82296, 82368, 82440, 82512, 82584, 82656, 82728, 82800, 82872, 82944, 83016, 83088, 83160, 83232, 83304, 83376, 83448, 83520, 83592, 83664, 83736, 83808, 83880, 83952, 84024, 84096, 84168, 84240, 84312, 84384, 84456, 84528, 84600, 84672, 84744, 84816, 84888, 84960, 85032, 85104, 85176, 85248, 85320, 85392, 85464, 85536, 85608, 85680, 85752, 85824, 85896, 85968, 86040, 86112, 86184, 86256, 86328, 86400, 86472, 86544, 86616, 86688, 86760, 86832, 86904, 86976, 87048, 87120, 87192, 87264, 87336, 87408, 87480, 87552, 87624, 87696, 87768, 87840, 87912, 87984, 88056, 88128, 88200, 88272, 88344, 88416, 88488, 88560, 88632, 88704, 88776, 88848, 88920, 88992, 89064, 89136, 89208, 89280, 89352, 89424, 89496, 89568, 89640, 89712, 89784, 89856, 89928, 90000, 90072, 90144, 90216, 90288, 90360, 90432, 90504, 90576, 90648, 90720, 90792, 90864, 90936, 91008, 91080, 91152, 91224, 91296, 91368, 91440, 91512, 91584, 91656, 91728, 91800, 91872, 91944, 92016, 92088, 92160, 92232, 92304, 92376, 92448, 92520, 92592, 92664, 92736, 92808, 92880, 92952, 93024, 93096, 93168, 93240, 93312, 93384, 93456, 93528, 93600, 93672, 93744, 93816, 93888, 93960, 94032, 94104, 94176, 94248, 94320, 94392, 94464, 94536, 94608, 94680, 94752, 94824, 94896, 94968, 95040, 95112, 95184, 95256, 95328, 95400, 95472, 95544, 95616, 95688, 95760, 95832, 95904, 95976, 96048, 96120, 96192, 96264, 96336, 96408, 96480, 96552, 96624, 96696, 96768, 96840, 96912, 96984, 97056, 97128, 97200, 97272, 97344, 97416, 97488, 97560, 97632, 97704, 97776, 97848, 97920, 97992, 98064, 98136, 98208, 98280, 98352, 98424, 98496, 98568, 98640, 98712, 98784, 98856, 98928, 99000, 99072, 99144, 99216, 99288, 99360, 99432, 99504, 99576, 99648, 99720, 99792, 99864, 99936, 100008, 100080, 100152, 100224, 100296, 100368, 100440, 100512, 100584, 100656, 100728, 100800, 100872, 100944, 101016, 101088, 101160, 101232, 101304, 101376, 101448, 101520, 101592, 101664, 101736, 101808, 101880, 101952, 102024, 102096, 102168, 102240, 102312, 102384, 102456, 102528, 102600, 102672, 102744, 102816, 102888, 102960, 103032, 103104, 103176, 103248, 103320, 103392, 103464, 103536, 103608, 103680, 103752, 103824, 103896, 103968, 104040, 104112, 104184, 104256, 104328, 104400, 104472, 104544, 104616, 104688, 104760, 104832, 104904, 104976, 105048, 105120, 105192, 105264, 105336, 105408, 105480, 105552, 105624, 105696, 105768, 105840, 105912, 105984, 106056, 106128, 106200, 106272, 106344, 106416, 106488, 106560, 106632, 106704, 106776, 106848, 106920, 106992, 107064, 107136, 107208, 107280, 107352, 107424, 107496, 107568, 107640, 107712, 107784, 107856, 107928, 108000, 108072, 108144, 108216, 108288, 108360, 108432, 108504, 108576, 108648, 108720, 108792, 108864, 108936, 109008, 109080, 109152, 109224, 109296, 109368, 109440, 109512, 109584, 109656, 109728, 109800, 109872, 109944, 110016, 110088, 11016

example is where an individual wishes to play multiple roles in a musical composition written for several instruments. Relatively few machines provide for sound-on-sound recording.

This is possible on a machine with separate record and playback heads if it contains, or provides for installation of, an extra playback head *before* the erase head. In addition, a mixing facility is required, which may be part of the recorder. The sequence of events is: (1) The first signal is recorded and the reel re-wound. (2) The first signal is played back on the *extra* playback head and fed into the mixer along with the second signal; at the same time, for synchronization, the first signal is monitored by the performer with the aid of a headphone. (3) The mixed signal is fed to the record head, which records on clean tape inasmuch as the erase head lies between the extra playback head and the record head.

Self-Contained Sound System. With very few exceptions, the professional machines do not contain a power amplifier and speaker. The reverse is true among the lower priced home recorders, although an increasing number of these are appearing in basic form, that is, without a sound system. The essential advantage of a self-contained sound system is that it makes the tape recorder a complete and portable instrument. Also, it enables a home recorder to be used as a moderate-power public address system.

In view of the limitations imposed by size of the recorder housing and type of speakers commonly used, an internal single-ended power amplifier able to turn out two or three fairly clean watts (no more than 5% harmonic or intermodulation distortion over the 50-10,000 cps range) is sufficient. However, if the internal amplifier is expected to drive a high-grade external speaker, it should contain a push-pull output stage and supply at least five watts at less than 2% harmonic or intermodulation distortion over the frequency range covered by the basic tape recorder.

Solenoid Control. Where considerable tape handling is required because of editing or other considerations, control of the start, stop, rewind, and forward wind functions by means of solenoids—an extra feature that offers substantial added convenience over the manually-actuated type of levers. For everyday and most normal home use, however, solenoid control offers more gadgetry than increased convenience. From the servicing viewpoint, there is that much more to go wrong. Also, there is less “feel” to solenoid control, which means that if the tape handling mechanism is imperfect the chances of spilling or breaking tape are increased.

Reversibility. At least two home tape recorders now on the market record in either direction of tape travel, using a separate set of heads for each direction. Means are provided so that just before the tape runs out on one channel, the transport mechanism is automatically reversed and recording or playback proceeds on the second



VIKING
Full Fidelity
Professional Quality
TAPE COMPONENTS
... popularly priced!

Viking FF75 Series Playback/Record Decks
... from \$59.95 audiophile net

for pure pleasure

MONAURAL STEREOGRAPHIC RECORDING
PLAYBACK



Viking RP61 Record/Playback Amplifier...\$74.50 audiophile net



Viking PB60 Preamplifier ... \$24.50 audiophile net



Viking Pro Recorder ... \$165.00 audiophile net

SOLD THRU DEALERS—WRITE FOR INFORMATION

VIKING OF MINNEAPOLIS
Viking brings you faultless performance ... YOU TAKE IT FROM HERE!
3520 East 43rd St., Minneapolis 6, Minn. • Parkway 1-1651

Export Division: 25 Warren Street, New York 7, N. Y.
Cables: SIMONTRICE NEWYORK (All Codes)
Dist. in Canada by Musimart of Canada, 901 Bleury St., Montreal

RADIO and TELEVISION ELECTRONICS

 in all Technical Phases
New Classes (Day and Evening) Start 1st of Dec., Mar., June, Sept.
Free Placement Service for Graduates
For Free Catalog write Dept. RN56

RCA INSTITUTES, INC.
A Service of Radio Corporation of America
350 WEST 4TH ST., NEW YORK 14, N. Y.

Now In Stock at Van Sickle Radio Supply Co.
1320 Calhoun St. Ft. Wayne, Ind.

COLOR & BLACK & WHITE
5" — 5 MC SCOPE
KIT \$79.95 Wired \$129.50 #460



SOLA CONSTANT-VOLTAGE TRANSFORMER
Ends fluctuating line voltage!
OVER 60% OFF...



the factory price at a 1-input 2,000 VA unit! And here's another bonus! This Air Forces 2,000 VA overstock, Sola Cat. No. 30768, has 4 inputs! 90-125 V., 190-250 V., 60 cy. or 50 cy. Isolated secondary is constant 115.0 V. ± 1% from no-load to full-load of 17.4 amp. So, if you choose, use it as a 220:115 V. step-down. And slash \$147.50 off the factory 1-input price!
Brand new in original wood box. 4 cu. ft. Ship. wt. 254 lbs. F.O.B. **\$97.50**
Pasco, Wash. Only
(EXPORTERS: Note choice of 50 cycles.)
THE M. R. COMPANY
P. O. Box 1220-A Beverly Hills, Calif.

HOT! FREE! NEW!

- ★ **1956 Flyer**
 - ★ **Loaded with Hi-Fi**
 - ★ **& Surplus Bargains**
- Get your **FREE** copy today!

BOAT OWNERS: Ask for our Special Marine Bargain List! Free! Loaded with values!

AERONAUTICALS: Get our new, free Airborne Bargain List! Raff of moneysaving buys!

AUTOMATION FOR YOU!
Stop-Start Electro-Mechanical Devices!



24-HOUR TIMER
Start coffee, control lights, heater or humidifier, cook dinner, defrost refrigerator, wake up to radio or sprinkle your lawns—**ALL AUTOMATICALLY!** A handsome 24-hour clock, 115 V., 60 cycle, U.L. approved, with receptacle for appliance to be controlled. **ANY** or as long as 23 3/4 hours, starting at any moment during the 24 hour cycle. Repeats automatically every 24 hours or you can switch appliance on or off manually with lever at front without changing the automatic setting. Switch rated 7 amperes. \$75 W. "Intermatic" Time-All.

No. A221. Brand new. Only..... **\$9.95**

HERE'S SOMETHING TO TIME!

ELECTRICALLY-OPERATED SOLENOID VALVE: Water your lawn while you sleep! 1" standard pipe size. No opening in it is less than 1" diam. area. Normally closed; opens when 18-24 VDC at approx. 1/2 amp. is applied. Corrosion resistant. A \$75.00 value. **NEW** at only..... **\$2.95; 4 for \$10.00**

SELENIUM RECTIFIER & TRANSFORMER
For above valve OR ANY OTHER 24 VDC APPLICATION. Each rated at 1.2 amps, enough to handle 4 valves. **RECTIFIER \$1.98.**

TRANSFORMER..... \$1.98
COMBO SPECIAL DEAL Timer, 4 valves, rectifier, transformer, all for only..... **\$21.95**

TBY PORTABLE MOBILE 10 & 6

The Marine Corps' proud record at Iwo was due to the bravery of the Marines and the TBY's. Transmitter-receiver, 28-80 MC., AM. With tubes, antenna, mike and headset in carrying bag. With modification instruction to ktal control, original modified schematic, circuit explanation and power supply required. **NEW, less power..... \$29.95** sunny **TRANSCIVER UNIT only: Used, excellent condition, with tubes..... \$19.95**

MINIATURE PANEL METERS

1 3/4" sq., mounts in 1 1/2" hole. 2% ACCURATE! Balanced and damped. Handsome black calibration on white face. **ALL NEW AND ALL GUARANTEED!** DC: 0-1 ma; 0-200 ma.; 0-300 ma.; 0-15 V.; 0-30 V.; 0-500 V. **YOUR CHOICE. EACH..... \$3.95** 0-10 A DC..... **\$4.95** 0-3 A RF..... **\$6.95**
All shpts. FOB whse. Send 25% dep. with all COD orders. Item sub. to prior sale & change of price without notice. Min. order \$2.50.

ARROW SALES, INC.

Western Mailing Address:
Box 3007-R, NORTH HOLLYWOOD, CALIF.
Central Mailing Address & Sales Showroom
2441 S. MICH. AV., Dept. R, CHICAGO 16, ILL.
California Distributors' Stores
G. L. Electronics, Inc., 1632 Venice, Los Angeles
P.A.R.T.S., Inc., 2005 Empire Ave., Burbank

Crystals

BUY NOW AND SAVE UP TO 90%

4,000,000 GOVERNMENT SURPLUS CRYSTALS
NOVICE, FT-243
FT-171, FT-241,
FT-249, DC-34/35
SHIP BAND, MISC.

SAME DAY SERVICE!
SATISFACTION GUARANTEED!
OVER 5,000 FREQUENCIES!

SEND FOR FREE CATALOG

"The House of Crystals"

U. S. CRYSTALS, Inc.
805 S. UNION AVE. • LOS ANGELES 17, CAL.

channel. The extent to which reversibility is compatible with other motion requirements has been open to question in the past. However, one of the recorders in question claims that wow and flutter at 7.5 ips are only .1%, which, of course, would be excellent.

Miscellaneous. A complete list of all the features found in various tape recorders would be burdensomely long, although it is hoped that none of general importance have been excluded in this article. In closing, several more special features may be mentioned to indicate the range of requirements by tape recordists and the extent to which manufacturers try to meet their needs. One tape recorder, for example, provides automatic demagnetization of the heads. Otherwise, it is necessary for the recordist to periodically demagnetize the heads by means of an a.c. electromagnet. Another machine prevents magnetization of the record head due to sudden signal cut-off by providing a filter for gradual removal of current. Some machines make room for five or more heads in order to achieve echo chamber and other special effects. Cathode follower output to permit long cable runs is often found. Some machines can be operated by remote control, and so on—all depending on the features the manufacturers consider salable.

SERVICEMEN'S WEEK

FOR the second year, RCA is sponsoring a "National Television Servicemen's Week," from March 5 to 10, dedicated to the service technicians who install and service America's more than 37,000,000 television sets and 110,000,000 radios. Plans call for both a consumer advertising campaign by RCA with tie-ins by local service dealers, and local publicity campaigns by the service dealers themselves.

Some of the material available to service technicians and dealers for distribution to their customers during this week include a booklet, "How's Your Television I.Q.?" and TV safety glass cleaning cloths. A window-display plaque containing the code of ethics adhered to by most service dealers is also obtainable as are other window displays, postcards, mailing stickers, and ad mats from RCA distributors or RCA directly.

HOW'S YOUR MUSICAL EAR?

A "MUSICAL TESTER" that permits the audiophile to test his own "musical ear" has been installed by Federated Purchaser, Inc. at its Mountaineer, New Jersey hi-fi salon.

The unit is a "test-yourself" device. The user puts on earphones and manipulates one knob for pitch and another for volume. A steadily rising tone that soon becomes a shrill whistle and finally fades out is heard in the earphones. At whatever point the user fails to hear the signal—that is his hearing limit. The pitch dial, calibrated in cps can be read direct. The second dial permits the audiophile to find out how sensitive his hearing is at different frequencies.

Those who have tried the "Tester" report that results are informative and interesting.

Another Popular Photography Extra!
PHOTOGRAPHERS!
10¢ BRINGS YOU

"All About Electronic Flash"—

Here's a valuable six-section, easy-to-follow guide to electronic flash—what it is, what it does . . . its advantages and disadvantages, reprinted from POPULAR PHOTOGRAPHY.

This exciting pamphlet takes the confusion out of electronic flash by answering such questions as:

- How to Buy an Electronic Flash Unit
- How to Use It
- How to Shoot Color and Black and White
- How to Rate the Unit's Flash Output for Desired Effects

It tells you *all* there is to know about the exciting possibilities of electronic flash photography. Send for your copy of "All About ELECTRONIC FLASH" today—only 10c!

POPULAR PHOTOGRAPHY, Box RTN
366 Madison Avenue, New York 17, N. Y.

Here's my 10c. Please send me a copy of POPULAR PHOTOGRAPHY'S "All About ELECTRONIC FLASH."

Name _____
Address _____
City _____ Zone _____ State _____

SAVE UP TO 63% on TV PIX TUBES

- Standard RTMA 1-Year Guarantee
- Dark Face • No Trade-ins Needed

Sensational Bargain Prices in TV Pix Tubes—you save plenty of money—up to 63% Discounts. Your choice of Dark Face (flare-ease) or Aluminized faces. These tubes are high-quality RCA-licensed re-built tubes—each guaranteed for 12 months. No trade-ins needed. Factory-sealed cartons with manufacturer's registration warranty in carton. Perfect arrival guaranteed by Railway Express.

Type—Grey-Face	Bargain Net
12LP4*	\$11.95
16A, E, or GP4	18.95
16D, F, H, or JP4*	18.25
16R, K, or TP4*	16.95
16L, W, or ZP4*	18.50
17A or BP4*	17.25
17F, H, L, or VP4*	18.95
17G, T, or UP4	22.95
19AP4—Metal*	24.50
19E, or FP4*	23.00
20C or DP4*	20.50
20F, or HP4*	21.95
21A, D, or MP4—Metal	27.50
21E, F, K, W, X, Y, or ZP4*	23.50

* Above types also available in new aluminized Pix tubes—add \$3 for 12" thru 17" sizes—add \$4 for 18" thru 21".

SEND FOR FREE CATALOG

National Electronics
OF CLEVELAND
THE HOUSE OF TV VALUES
6608 Euclid Ave. Dept. N-3 Cleveland 3, Ohio

A Review of Servicing Techniques

(Continued from page 72)

here. An audio signal generator supplying a good sine wave and an oscilloscope may be used together to check individual stages for distortion, providing a combination of the two techniques. Since distortion is often caused by improper operating voltages and defective tubes, voltage tests and testing tubes will isolate the defect in some cases.

The radio receiver: A block diagram of a typical radio receiver is given in Fig. 5. Most technicians consider the receiver in sections rather than as individual stages for the preliminary isolation of defects. Individual stages are considered after the trouble is isolated to a specific section.

In Fig. 5, the sections are: audio (1st audio, audio output, and loudspeaker), i.f. (i.f. amp. and 2nd detector), r.f. (r.f. amp., mixer, and antenna), local oscillator, and power supply.

Defects generally encountered are: "dead," weak, intermittent, hum, oscillation, distortion, noise, and interference. Note that these complaints are essentially similar to those encountered in audio amplifiers. As with the audio amplifier, the same techniques are employed, but with slight modification. These modifications are dependent on the exact technique used.

For example, when using the signal tracing technique, an r.f. detector probe is necessary when checking the signal in the i.f. and r.f. sections. When signal injection is used, the type of signal must be changed as different sections are checked. In the i.f. section, a signal at the i.f. value is used (455 kc. for most AM sets, 10.7 mc. for most FM sets); in the r.f. section, a signal at the r.f. value to which the set is tuned; and in the audio section, an audio signal.

In addition, the special technique of alignment must be considered. This technique may prove valuable where the complaint is "dead set," "weak operation," "distortion," "interference," or "oscillation" (squeals or motorboating).

The TV receiver: The block diagram of the television receiver given in Fig. 6 is typical of many TV receivers currently available. Intercarrier sets have the sound channel connected from the video amplifier or, in some cases, the video 2nd detector. The sync pulses may be obtained from either the 2nd detector, as shown at "A" or from the video amplifier, as shown at "B."

As in the cases of the audio amplifier and the radio receiver, we have similar complaints to consider, but with an important modification, we must consider that each defect may apply to either the audio or the video sections of the receiver, or both.

Thus, when considering "distortion" as a complaint, we can concentrate the tests in that section of the receiver where the type of distortion indicates the defect to exist. Distorted sound, for example, is caused by a defect in either the audio i.f., discriminator, or audio stages.

The picture may be "distorted" in two ways. Either the picture quality may be poor (lack of definition), indicating a possible defect in the video amplifier, video 2nd detector, or misalignment of the video i.f. stages; or the picture shape may be distorted, indicating a defect in either the horizontal or vertical sweep circuits, or both.

From this, we see that a preliminary isolation of a defect in a TV receiver may be made using "effect-to-cause" reasoning. Once the defect is isolated to a section, the familiar techniques of signal tracing, signal injection, voltage analysis, stage blocking, etc., may be used to isolate the defect further, to a single stage and part.

Again, the technique must be modified slightly to take the receiver circuits into consideration. For example, the oscilloscope is preferred for signal tracing in video, sync, and sweep circuits. Other techniques are modified in a similar fashion, either by using slightly different equipment than that required for servicing audio amplifiers and radio receivers, or signals of different frequencies.

Fig. 7 is a chart summarizing the various techniques described in this article and indicating to which complaints these techniques may best be applied.

-30-

March, 1956

BUILD 16 PRINTED CIRCUIT AND METAL CHASSIS RADIO CIRCUITS

only \$19.95 complete

With the New Deluxe 1956 PROGRESSIVE RADIO "EDU-KIT"

Reg. U. S. Pat. Off. Pend.

Build 16 Receiver, Transmitter, Code Oscillator, Signal Tracer, Signal Injector Circuits

- No Knowledge of Radio Necessary
- No Additional Parts Needed
- Excellent Background for TV
- Learn High Fidelity
- Used in 79 Countries
- School Inquiries Invited
- Learn Practical Radio Theory, Construction



FREE RADIO and TELEVISION SERVICING LITERATURE ON REQUEST (See Coupon Below)

WHAT THE "EDU-KIT" OFFERS YOU

Our Kit is designed to provide a fundamental background in radio, with the basic facts of Radio Theory and Construction Practice expressed simply and clearly. You will gain a knowledge of basic Radio Principles involved in Radio Reception, Radio Transmission and Audio Amplification. You will learn how to identify Radio Symbols and Diagrams; how to build and troubleshoot radio circuit schematics; how to mount various radio parts; how to wire and solder in a professional manner. You will learn proper chassis layout. You will learn Printed Circuitry. You will learn how to service and troubleshoot radio sets and their accessories. You will receive training for F.C.C. Novice License. You will learn High Fidelity. In brief, you will receive a practical basic education in radio, worth many times the small price you pay.

THE KIT FOR EVERYONE

The Progressive Radio "Edu-Kit" was specifically prepared for any person who has a desire to learn Radio. The Kit has been used successfully by young and old in all parts of the world. It is not necessary that you have even the slightest background in science or radio.

The Progressive Radio "Edu-Kit" is used by many Radio Schools and Clubs in this country and abroad. It is used by Armed Forces Personnel and Veterans throughout the world for training and rehabilitation.

The Progressive Radio "Edu-Kit" requires no instructor. All instructions are included. All parts are individually boxed, and identified by name, illustration and diagram. Every step involved in building these sets is carefully explained.

"LEARN BY DOING"—PROGRESSIVE TEACHING METHOD

The Progressive Radio "Edu-Kit" comes complete with instructions. These instructions are arranged in a clear, simple and progressive manner. The theory of Radio Transmission, Radio Reception, Audio Amplification and servicing by Signal Tracing is clearly explained. Every part is identified by illustration and diagram. You will learn the function and theory of every part used.

The Progressive Radio "Edu-Kit" uses the principle of "Learn by Doing." Therefore you will build radio circuits, perform jobs, and conduct experiments to illustrate the principles which you learn. These circuits are designed in a modern manner, according to the best principles of present-day educational practice. You begin by building a simple radio. The next set that you build is slightly more advanced. Gradually, in a progressive manner, you will find yourself constructing still more advanced multi-tube radio sets and doing work like a professional Radio Technician. Altogether you will build Receiver, Transmitter, Code Oscillator, Signal Tracer, Signal Injector—16 in all. These sets operate on 105-125 V. AC/DC. For use in Foreign Countries having 210-250 Volt Source, and Adaptor for 210-250 V. AC/DC operation is available.

THE PROGRESSIVE RADIO "EDU-KIT" IS COMPLETE

You will receive every part necessary to build 16 different radio circuits. Our "Edu-Kits" contain all tubes, tube sockets, chassis, variable, electrolytic, and paper condensers, resistors, tie strips, coils, hardware, tubing, instruction Manuals, Printed Circuit chassis, printed circuit tube sockets and hardware, printed circuit illustration Manual, etc. Selenium rectification is used throughout. Every part that you need is included. These parts are individually packaged, so that you can easily identify every item. Soldering iron is included, as well as an Electrical and Radio Tester. Complete, easy-to-follow instructions are provided. All parts are guaranteed, brand new, carefully selected and matched.

In addition, the "Edu-Kit" now contains lessons for servicing with the Progressive Signal Tracer and Signal Injector, F.C.C. instructions, quizzes, High Fidelity Instructions. The Progressive Radio "Edu-Kit" is a practical home radio course at rock bottom price.

TROUBLE-SHOOTING LESSONS

Trouble-shooting and servicing are included. You will be taught to recognize and repair troubles. You will build and learn to operate a professional Signal Tracer and Signal Injector. You will receive an Electrical and Radio Tester, and learn to use it for radio repairs. While you are learning in this practical way, you will be able to do many a repair job for your neighbors and friends, and charge fees which will far exceed the cost of the "Edu-Kit." Here is your opportunity to learn radio quickly and easily and have others pay for it. Our consultation service will help you with any technical problems which you may have.

Printed Circuitry Now Included

You build a Printed Circuit Signal Injector, a servicing instrument that can detect many Radio and TV troubles. A Printed Circuit is a special insulated board on which has been deposited a conducting material which takes the place of wiring. Various parts are plugged in and soldered to terminals. This new process is now popular in commercial radios, TV, hearing aids, industrial electronics, etc.

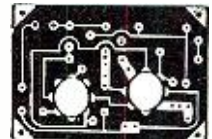

FREE EXTRAS

- RADIO AND ELECTRICAL TESTER • ELECTRIC SOLDERING IRON
- HIGH FIDELITY GUIDE • QUIZZES • CONSULTATION SERVICE
- TESTER INSTRUCTION MANUAL • TELEVISION BOOK

30 DAY UNCONDITIONAL MONEY-BACK GUARANTEE

- MAIL TODAY—ORDER SHIPPED SAME DAY RECEIVED
- Send "Edu-Kit" Postpaid. I enclose full payment of \$19.95.
 - Send "Edu-Kit" C.O.D. I will pay \$19.95 plus postage.
 - Send me FREE additional information describing "Edu-Kit." Include FREE valuable Radio and TV Servicing Literature. No obligation. (Outside U.S.A.—No C.O.D.'s. Send check on U.S. bank or Intern't'l. M.O. "Edu-Kit" for 105-125 V. AC/DC \$20.95; 210-250 V. AC/DC \$23.45.)

Name

Address

PROGRESSIVE "EDU-KITS" INC.
497 Union Ave., Room 51E, Progressive Bldg., Brooklyn 11, N. Y.

STAN-BURN

CATHODE RAY TUBE SPECIALS

ONE YEAR GUARANTEE

G.E.	Type	STAN-BURN	G.E.	Type	STAN-BURN	
\$13.25	10BP4	\$10.20	\$28.15	17CP4	\$19.50	
18.00	10FP4	14.00	31.25	17GP4	20.75	
16.25	12LP4A	13.95	32.25	19AP4A	22.50	
	12QP4	10.50	27.40	20CP4	18.95	
28.95	12UP4	14.50	33.00	21AP4	22.25	
18.15	14P4	13.40	33.25	21MP4	23.50	
	15DP4	14.50	27.40	21EP4	20.15	
31.25	16AP4A	16.00	90.75	24AP4	49.00	
26.25	16KP4	15.75	DUMONT TUBES			
31.25	16GP4	18.50	12QP4A	23.75	16FP4	26.00
29.00	16LP4	15.25	15DP4	26.55	17KP4	25.00
29.00	16WP4	15.25	16DP4A	31.00	19AP4A	33.25
22.50	17BP4	15.75			21KP4	38.50

PRICES SUBJECT TO CHANGE WITHOUT NOTICE

\$20 WORTH OF ELECTRONIC PARTS IN GRAB-BAG consisting of: Porcelain sockets, coils, speaker, transformers, resistors, condensers, etc. ONLY \$1.98 (plus 50¢ postage).

NEW G. E. PHONO CARTRIDGES

G.E. Original Boxed

RPX050A	.001 and .003 (SS)	\$ 6.78
RPX052A	Golden Treasure (DS)	19.38
RPX053A	Golden Treasure (DS)	28.08
RPX040A	.003 Single (S)	5.09
RPX041A	.001 Single (S)	5.09
RPJ010A	Dual (S) .001 and .003	1.52
RPJ012A	Dual (D) .001 and .003	18.43
RPJ013A	Dual (DS) .001 and .003	10.66
RPJ010	or RPJ010 Single (D)	9.69
RPJ015	or RPJ015 Single (S)	1.29
Replacement stylus for RPX040 & 041 only.		
RPJ001	or RPJ001 Single (S) G.E.	1.29
RPJ003	or RPJ003 Single (D)	9.69

VM 3 SPEED HI-FI CHANGER—Model 950 with Ronette Sonotone or Astatic flip-over cartridge—BRAND NEW, ORIGINAL CARTONS . . . \$21.49

WEBSTER Model 140—3 SPEED Automatic with Ronette Sonotone or Astatic flip-over cartridge . . . \$22.49

RC54 Collaro—less cartridge . . . \$34.95
RC54 Collaro with Ronette flip-over cartridge . . . \$37.95
With G.E. plug-in RPX050 . . . \$39.95
With G.E. plug-in RPX052 . . . \$59.95

HALICRAFTERS TV

Model 17T5700M—Table Model . . . Dealer net \$ 88.95
Model 21T5480M—Table Model . . . Dealer net 129.46

ANTENNA ACCESSORIES

P-800 JFD DOUBLE "V" ant., box of 10 . . .	\$1.39
FLASH-DOUBLE "V" lightning arrest., box of 12 . . .	2.09
REGO-DYNAMIC BALL, SW/TYPE INDOOR Ant. . .	2.69
Ant. . .	2.19
RMS-SW/TYPE INDOOR Ant., list 9.95 . . .	ea. 1.19
10' ALUMINUM MASTS . . .	ea. .69
5' SWEDGED MASTS . . .	ea. 2.39
10 ELEMENT CONICAL . . .	ea. 2.19
ZIP 5 JFD 10 ELEMENT CONICAL . . .	ea. .99
ZIP 2 JFD 8 ELEMENT CONICAL . . .	ea. 1.29
SPICO 5-8 INDOOR RABBIT EARS Ant. . .	ea. 1.19
JFD TA141 INDOOR RABBIT EARS Ant. . .	ea. 1.29
JFD TA144 INDOOR RABBIT EARS Ant. . .	ea. 1.29
55 MILL 300 OHM WIRE—1000 Feet . . .	12.49
80 MIL 300 OHM WIRE—1000 Feet . . .	13.99
100 MIL 300 OHM WIRE—1000 Feet . . .	13.99

ATTENTION! DOMESTIC AND FOREIGN AUTO RADIO DEALERS, JOBBERS AND AUTOMOBILE AGENCIES.

Our Auto Radio dept. can now supply you with CUSTOM FIT MOTOROLA RADIOS. These radios are adapted by skilled mechanics to fit exactly the same as factory installed sets, without using complicated and unsightly panels. Send for samples to convince yourself. MONEY BACK GUARANTEE. All Models are PUSH-BUTTON.

PLYMOUTH '55-'56	\$53.00
DODGE '55-'56	54.00
OLDSMOBILE '55-'56	59.00
FORD '56 only	55.00
BUICK '55-'56	66.00

Other models available—write for prices.
DISAPPEARING ANTENNA . . . \$3.35
3 SECTION COWB ANTENNA . . . 1.19
12 VOLT 3 & 4 prong Universal vib. . . 1.49
6 VOLT 4 prong Universal vib. . . 1.19
(Quantity users—write for quotations)

Our Delco and GM dept. will be glad to supply you with your AUTO RADIO electronic needs.

DEALERS: Write for low cost prices and catalogs on '56 models—HALLICRAFTERS, CRESCENT, FANNON, SONORA, WILCOX-GAY, TECHNOMASTER, GUNTING, SUN-TUNG-SOL, DeWALD, MAJESTIC, GRUNDIG, CAPEHART, DELCO, GEN. MOTORS. Address all inquiries to Dept. RN-3.

Our High Fidelity department will promptly quote on any item in the HI-FI field. Send us your list for our lowest quotations.

We invite export inquiries and offers. Our export department will give special attention to expediting foreign orders at minimum commissions. We are authorized distributors for United Motors, all Delco and Gen. Motors Auto Radio parts in stock. We also carry a complete line of popular makes of Radio Tubes at 50/10 discount. Also many other special purpose and transmitting tubes, and all electronic parts and equipment at lowest prices. Send us a list of your requirements for prompt quotations. Terms: 20% with order. Balance C.O.D. All prices F.O.B. NEW YORK Warehouse. Minimum order \$5.00. Write for our latest price list and Hi-Fi Catalog RN-3.

STAN-BURN RADIO and ELECTRONICS CO.
558 CONEY ISLAND AVE. • B'KLYN 18, N. Y.

Mobile Transmitters

(Continued from page 52)

Incidentally, right about here, if the current will not reach the rated value on a transmitter using the shunt and low-range meter method of tuning indication, check the meter you are using. If the internal resistance of the meter is not identical with that used by the manufacturer to make the original set of readings, you may be led astray. This caused us a great deal of trouble a few years ago. We finally had to make up a set of "comparison-readings," correlating the readings we were getting and the actual readings on the manufacturer's "test-set." Of course, in a circuit like this, a jumper may be clipped off the meter jack and the actual current measured, by inserting the meter there. Full-load currents may be found in the manual or in a tube-characteristics book. (See Fig. 2.)

If the plate current will not reach the rated value, check the tubes. This is best done by substituting new ones, as the average tube tester will not load a transmitting tube heavily enough for a reliable test. If this brings the current up to normal, fine; if not, more tests must be made. Check the supply voltages: the vehicle's battery may be a bit low and the drain of the transmitter may be causing an excessive drop. For the best test, the engine should be turning over fast enough to cause the generator to charge during final adjustments. This will more closely approximate actual operating conditions and give a better adjustment.

If the plate will dip, but the loading adjustments fail to respond normally, such as refusing to come up to full power, or show a large, above-normal reading and the adjustments have no effect, check the antenna for opens or shorts. A grounded antenna will give very peculiar readings, especially on the higher frequencies. An open circuit in the lead-in will negate the effect of all loading adjustments.

One of the handiest instruments for checking this adjustment is a radiation indicator. This can be made up in the shop, using a crystal detector and a short pickup rod. (See Fig. 3.) The

Fig. 2. (A) Reading final plate current by inserting meter in cathode circuit. This requires meter capable of reading actual plate current. (B) Reading final plate current by using a 50 μ a. meter across a 1-ohm shunt resistor. To read actual plate current, shunt may be opened and high-range meter used. Refer to discussion in text.

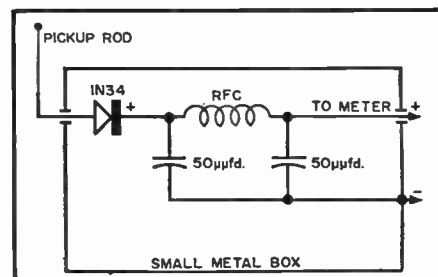
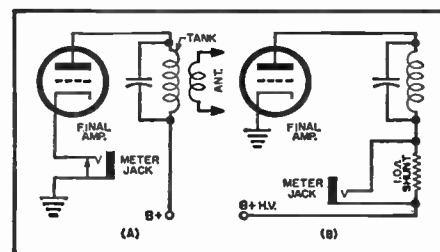

Fig. 3. Radiation indicator for checking actual output of transmitter. Output of detector is connected to multimeter, on suitable low-current range. If this gadget is set up in the same place each time, it may be used as a fairly accurate output indicator. Note readings for each test. A falling off indicates a need for checking transmitter. Parts values are not critical. Filter shown may be eliminated entirely without affecting performance too adversely.

output of this device is connected to the same multimeter used for the tuning adjustments. This is set up near the antenna, so that the rod will pick up a portion of the radiated signal. The meter may be set on whatever range is necessary to provide a usable reading: this will be in the 50- μ a. range on the 152-174 mc. bands and in the 1-5 ma. range on the 40-50 mc. bands. After making final adjustments, set up this instrument, key the transmitter, and touch up the loading and tuning adjustments for a maximum reading on the meter. Be sure that the pickup rod is not moved during this process as this would cause erroneous readings. The reading seen is the actual rectified signal voltage and thus is the best test of the accuracy of your tuning adjustments.

One more word of caution: check antennas very carefully! Many troubles may be traced to them. Some time ago, we got a truck with a radio on 153 mc. These sets use a very small antenna, made of spring wire, only 19 inches long: almost invisible from over a few feet away. Complaint was "reception but no transmission." We checked the tuning: dip, but no load. Hmm. Changed final tubes. No results. Checked antenna; no short. About 20 minutes later, as we were on the way back into the shop for tools to remove the transmitter, we happened to glance up at the roof of the truck cab. Hmmm! It is difficult to load up an antenna when said antenna is lying by the side of the road, somewhere out of town! In other words, no antenna! About a one-inch stub remained, enough to pick up signals for the receiver when near the base transmitter, but not enough to get any signal out of the transmitter! After replacing the antenna, no trouble getting full load. Moral: Never take anything for granted: check fully, then make your diagnosis!

Just a final word of caution. Technicians who specialize in servicing two-way radio equipment are reminded that they must hold the pertinent FCC license before making adjustments on any transmitter!

Tape System—Preamp

(Continued from page 51)

sions somewhat, increasing the height, width, and length of the preamp by as much as an inch. The over-all construction and wiring would be somewhat simplified as a result. This would also eliminate the need for selecting components such as the power transformer and filter capacitors on the basis of physical size as well as electrical characteristics. The same general arrangement should be used, however. It will be noticed that in this design the chassis itself provides a part of the shielding, isolating the power supply components from the input and interstage amplifier circuitry.

Operating convenience would dictate the use of an a.c. switch on either the equalization control or the gain control. To do so, however, would necessitate bringing a.c. leads into proximity with the input stage and would increase the hum level by several db. The amplifier should therefore be operated from a switched outlet, such as is usually provided on commercial high-fidelity amplifiers.

A number of wiring precautions are prerequisite. All filament leads must be tightly twisted and run along the non-critical side of the chassis, away from the tube sockets, resistors, and capacitors. It should be noted that the circulating a.c. currents in the shielding have a pronounced effect if capacitors or signal circuit wiring are so dressed as to lie close to a gap in the shielding. Such a gap occurs, for example, along the sides of the internal chassis where a gap is formed between the chassis and the case.

Only one ground is permissible and this must be at the cathode of 5879 amplifier tube. All other grounds within the amplifier should terminate at this same point. For example, if the outside shield of the input cord is grounded where it enters the case, the resultant ground loop increases the hum voltage 6 to 10 db. Be sure that rubber covered shielded wire is used between the input connector and the grid of the 5879 stage. The input connector can be eliminated entirely, of course, by bringing the rubber-covered, shielded lead directly to the grid, grounding the shield at the cathode of this stage.

A Mumetal shield may be provided for the 5879 as well as the standard metal shield. The precaution is worth 2 to 3 db of added signal-to-noise ratio at the least. Remember that wide dynamic range requires high signal-to-noise ratio. The time and effort spent in these little niceties of construction will be well compensated for by improved performance.

The required 6 db-per-octave compensation is affected by the plate impedance, the 0.01 μ f. capacitor C_3 and the 25,000 ohm potentiometer R_3 . The use of a potentiometer permits variation of the actual compensation characteristic within limits of approximate-

March, 1956

from the VOICE OF AUTHORITY IN SWEEPS...

SPOT and FIX TV FAULTS FAST!

FREE RAM BOOK SHOWS HOW!

Typical latest field-proven servicing data you'll find in your RAM book:



FAULT—Picture compression and stretching.

CAUSE—Capacitance value of boost capacitor (connected to linearity coil) too low.



FAULT—Trapezoidal pattern. CAUSE—Short in horizontal winding of Yoke.



FAULT—Split picture.

CAUSE—Reversed AGC winding of H. Output Transformer; insufficient AGC voltage or reversed polarity.

For over 10 years, RAM has specialized and pioneered in sweeps exclusively. RAM designs them, makes them, counsels TV set manufacturers on them, field-services them, educates Servicemen on them—leads the industry.

No one but RAM can bring you such proven data—as shown here and in the RAM Manual. In manufacturing know-how and field experience, you can depend on RAM for...

THE VOICE OF AUTHORITY IN SWEEPS

Send coupon today—get the BEST information from the FOREMOST manufacturer now!



RAM ELECTRONICS SALES CO. • Irvington, N. Y.
Canadian Sales Division: Telegquipment Mfg. Co., Ltd., Ontario
Export Dept: Dage Corp., 219 E. 44 St., New York, N. Y.

THE NEWEST!

Rebel K-3

CORNER SPEAKER CABINET KIT

kitform of the original corner speaker horn
... one of 39 new units!

slightly higher west end south **\$54**

Write for Complete Catalog
36 pages of radio furniture kits and speakers for the high fidelity home music system.

cabinart '56

'56

Cabinart

99 North 11th Street, Brooklyn 11, N. Y.
largest manufacturer of cabinets and kits for hi fi
a division of G & H Wood Products Co., Inc.

A U D I O T V TELLS HOW TO ANSWER RADIO T.V. QUESTIONS

SERVICE LIBRARY

HERE IS LATE INFORMATION IN A HANDY FORM FOR TELEVISION AND RADIO REPAIRMEN, SERVICEMEN AND STUDENTS

AUDEL'S T.V. RADIO SERVICE LIBRARY—Highly Endorsed—Over 1500 Pages—1048 Illustrations & Diagrams. 1001 Important Facts & Figures on Modern Television, Radio, Electronic Devices at your finger ends.

INCLUDES TRANSISTORS & Transistor Circuits, Record Changers, Rectifiers, P.A. Systems, Tape Recorders, Phonograph Pick-ups, F.M., Auto Radio; Radio Compass, Short Wave, Radar, etc.

ASK TO SEE IT! IT WILL PAY TO KNOW—
The Basic Principles—Construction—Installation—Operation—Repairs—Trouble Shooting. Shows How to get Sharp, Clear T.V. Pictures. Install Aerials—How to Test. Explains Color Systems, Methods of Conversion, Terms, etc. Includes Ultra High Frequency—Valuable for Quick Ready Reference and Home Study.

\$6 COMPLETE 2 VOLUMES

Get this Information for Yourself.
7 DAY TEST—PAY ONLY \$1 A Month

MAIL ORDER

AUDEL Publishers, 49 W. 23 St., N.Y. 10, N.Y.
Mail AUDEL'S T.V. RADIO SERVICE LIBRARY (2 Volumes) \$6 on 7 days free trial. If O. K. I will remit \$1 in 7 days and \$1 monthly until \$6 is paid. Otherwise I will return them.

Name _____
Address _____
Occupation _____
Employed by _____

RN

EXPAND YOUR TAPE RECORDER SALES!!



with

INVERTERS

for changing your storage battery current to A.C. *Household* ELECTRICITY *Anywhere*

... in your own car!

Make your car, boat or plane a "ROLLING OFFICE"



mounted out of sight under dash or in trunk compartment!

EASY TO INSTALL
EASY TO OPERATE

ATR INVERTERS

especially designed for operating standard 110 volt A. C. . . .

- TAPE RECORDERS
- WIRE RECORDERS
- EXECUTIVES
- SALESMEN
- PUBLIC OFFICIALS
- POLICEMEN
- FIREMEN
- DICTATING MACHINES
- ELECTRIC RAZORS
- OUTDOOR MEN
- REPORTERS
- FIELD INSPECTORS
- DOCTORS
- LAWYERS, ETC.

See your jobber or write factory

✓ NEW MODELS ✓ NEW DESIGNS ✓ NEW LITERATURE
"A" Battery Eliminators, DC-AC Inverters, Auto Radio Vibrators



AMERICAN TELEVISION & RADIO CO.

Quality Products Since 1931

SAINT PAUL 1, MINNESOTA, U. S. A.

ly 8 db above and below the NARTB response curve at 10 kc.

The blocking capacitor C_6 in the output of the cathode-follower section of the 12AX7 can be a critical component under certain conditions. The cathode follower has an effective output impedance of 400 ohms, but with the 0.047 μ fd. capacitor shown, is intended for operation into a relatively higher impedance, such as the input to the typical high-fidelity amplifier. Under this condition, it provides all the advantages of a low-impedance line, yet the instantaneous voltage appearing across this line appears merely as a voltage to a high-impedance input. Thus, there is no problem of matching impedances. If, however, this 400-ohm cathode follower is to be fed to a low-impedance input, such as a coupling transformer in a broadcast console, it is necessary to short out C_6 entirely, or replace it with a capacitor having a value of at least 25 μ fd. An electrolytic capacitor of such value installed at this point would be inserted with the positive side of the capacitor at the cathode level.

Feeding into a high-impedance amplifier input, C_6 can be shorted out or omitted entirely if a blocking capacitor is provided in the amplifier input circuitry. If such a capacitor were not provided, however, the d.c. voltage appearing across the cathode-follower stage would be applied to the grid of the amplifier.

The power supply is of typical de-

sign and requires no specific consideration. The transformer chosen, however, should provide very nearly the exact voltages indicated.

Performance Check

A listening test using a recorded music tape should suffice to show whether the preamplifier is functioning properly. Connect the output of the preamplifier to an unequalized (flat response) input on the power amplifier. Preferably, use a shielded lead no longer than 36" to connect the input of the preamplifier to the tape playback head. If the preamplifier is operating properly, the gain control should permit adjustment of the gain from zero to full amplifier output playing standard recorded music tapes. The compensation control should permit adjustment above and below the desired high-frequency response.

If a signal generator and vacuum-tube voltmeter are available, the following test procedure will result in conclusive performance data. Using a 100-cycle signal (the region of maximum preamplifier gain), adjust the signal input level to 0.002 volt. The preamplifier output should read approximately 2 volts at a maximum setting of the gain control.

Insert a shorting plug in the preamplifier input connector and again measure the output. This reading, representative of the residual hum, should not be greater than .025 volt.

To determine the NARTB equaliza-

Fig. 7. Mechanical details of metal work. There are three parts involved; shield, chassis, and a cover. Since these three parts must fit together many of the dimensions on the diagram have been purposely omitted. Variations in sizes of components would also change specific locations of mounting holes. Make sure that all parts will fit before proceeding too far. The method of mounting the transformer is for the Viking unit. The bracket flanges are simply bent around the shield. The rectifier tube socket is so mounted that the base of the tube itself sticks through the shield to the opposite side. Use 1/4" metal spacers to mount socket away from the shield. Both phono jacks are mounted on a single Bakelite base. Metal brackets are then used to mount to the chassis. To avoid possible hum pickup the filament leads between the two amplifier tubes are run through the two holes (E) to the opposite side of the shield. These two holes should be placed as close to the heater pins of their respective tubes as possible. As mentioned in the article, the mechanical details shown below are for the commercial unit but can be duplicated at home. Increasing over-all size would make construction easier.

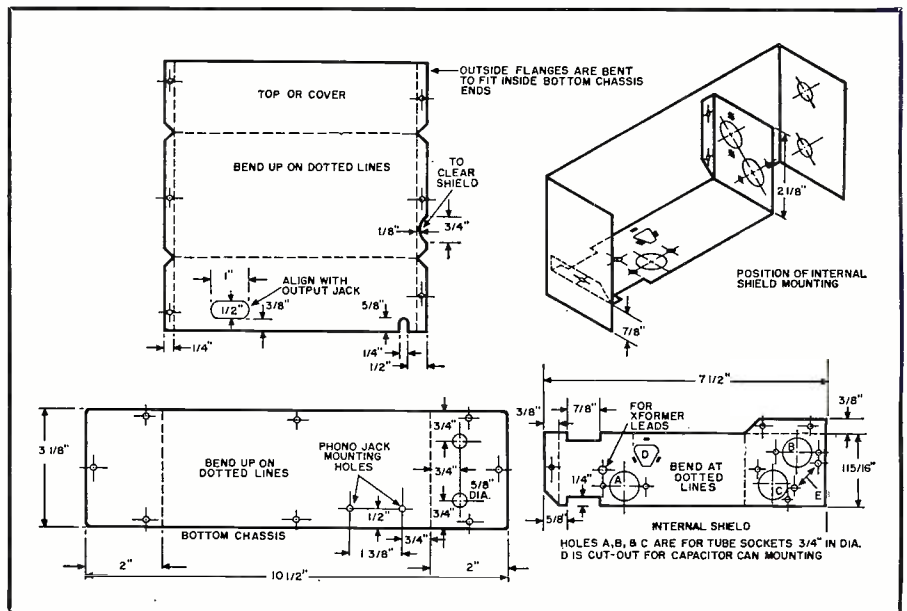

tion setting for the compensation control, apply a .002-volt, 100-cycle signal at the input of the preamplifier and adjust the gain control to provide an output of 15 db. Apply a 10 kc. signal of the same value and adjust the equalization control to provide a reading 15 db below zero reference. Plot a curve, if desired, using frequencies of 100, 500, 1000, 5000, 10,000, and 20,000 cycles-per-second. The curve obtained should correspond closely to that indicated in Fig. 3.

One of the most persistent questions asked by new enthusiasts is, "If I add a bias oscillator can my playback pre-amplifier be used for recording as well as playback?"

This is not practical because of the almost diametrically opposite equalization characteristics required. The switching circuitry necessary to make a dual purpose record-playback amplifier is so extensive that the construction of a complete, integrated, record-playback and high-frequency bias unit is infinitely more practical. Those who intend ultimately to build such a unit will still find the preamplifier described here to be a useful adjunct to their tape systems, however, since it may then be used with a third head in an erase-record-monitor head configuration for simultaneous monitoring directly from the recorded track.

(Continued in April issue)

Mac's Service Shop

(Continued from page 76)

fool!" Without another word he bolted through the door.

"Say, that was better than a soap opera," Barney exclaimed. "I guess Elmer proves that in radio servicing the customer is not always right."

"That saying came from the retail selling business," Mac agreed; "and it most certainly does not apply to any kind of servicing. After all, there is no reason to suppose that the customer knows anything about the equipment he brings you to repair. If he did, he would probably repair it himself. A funny thing is, though, that few of the men customers like to admit this ignorance. They like to have you believe that if they just had the tools and the time, they could repair their radio and TV sets themselves.

"The good technician does not destroy this fiction, but neither does he buy it. He listens politely to the customer's opinions, but then he relies on his own knowledge and experience to determine what is wrong and to correct it. He does not take refuge behind that business of the customer always being right to justify putting in parts not needed or performing unnecessary services, any more than a doctor would take out a sound appendix simply because the patient is convinced his gall bladder pains are from appendicitis."

"Yep," Barney agreed, "I guess it is part of our job to protect customers from their own ignorance!"

-30-



ALL FOR
\$7.95
list

Weller Soldering Gun—Model 8100, a \$7.95 value

Wire-bristle Soldering Brush for cleaning connections—streamlined for getting into tight places

Famous Kester Solder—generous supply

Soldering Aid for opening old joints, holding down and twisting wires—nothing handier!

FIRST AGAIN! Yes, Weller WAS first to invent... first to patent... first to sell. And today Weller IS first in sales... first in features... first in value.

MODEL 8100 WELLER GUN

Soldering hot in 5 seconds!

Over 100 watts—ample power for normal service
• Perfect hand-balance grip • Dual spotlights light up work • Triggermatic control—instant "on-off" heat • Streamlined design for maximum reach • Long-life Wellertips.

SEE THIS BIG SOLDERING TOOL VALUE. ASK YOUR DISTRIBUTOR FOR A DEMONSTRATION... OR WRITE DIRECT FOR CATALOG BULLETIN

Weller

ELECTRIC CORPORATION
Easton, Pennsylvania



**GROUND
RODS**

Copper Plated, Complete with Clamp!

It's easy to make positive, permanent antenna grounds with Premax Ground Rods. Chisel-pointed, hard-drawn steel drives fast. Pure copper electroplating resists rust, insures perfect electrical contact. 4 to 8 foot lengths.

Ask your jobber for Premax Ground Rods, or write



**NO PARTS
TO LOSE**

Adjustable conductor clamp comes pre-assembled, can't slip off. Holds No. 4 to 14 solid or strand conductor.

PREMAX PRODUCTS

DIVISION CHISHOLM-RYDER CO. INC., 5602 HIGHLAND AVE., NIAGARA FALLS, N. Y.

for the finest in sound



Acrosound

ULTRA-LINEAR

BEST FOR EL-34/6CA7 AND 6550 OUTPUT TUBES

The Acrosound TO-330* transformer assures a perfect match for EL-34/6CA7 and 6550 output tubes. Percentage of screen winding is chosen according to Mullard recommendation for operation of the EL-34 tube. Screen and plate winding sections are interleaved and tightly coupled for maximum power output over the greatest bandwidth.

Excellence of performance is illustrated by the TO-330 used with EL-34 tubes:

- Frequency response \pm 1DB, 2CPS to 220 KC
- Power output 50 watts 20 CPS — 30 KC
- Intermod. dist. — 1/2 at 50 watts
- Damping factor — 15

Impedance of the TO-330 is 3800 ohms plate to plate to 4, 8, 16 ohms. Primary taps are located at 40% for best Ultra-Linear performance.

Price: \$39.75 at leading distributors.

Acrosound output transformers with Acro-developed Ultra-Linear amplifiers assure the finest in sound. Lows are more articulate, transient qualities of highs are preserved and reproduced with sparkling realism. Details and catalog upon request!

* patented



ACRO PRODUCTS COMPANY

369 Shurs Lane, Philadelphia 28, Pa.

162

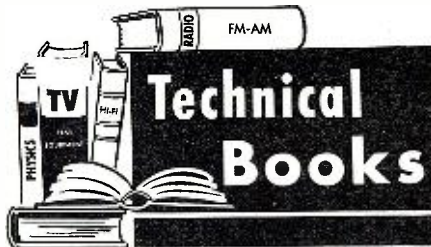

"MODERN OSCILLOSCOPES AND THEIR USES" by Jacob H. Ruitter, Jr. Published by *Rinehart & Company, Inc.*, New York. 337 pages. Price \$6.50. Revised edition.

This is a new and up-to-date version of a basic text which originally appeared in 1949. While the principles underlying the original work have not changed, this revision was made to give the student, technician, and researcher the latest possible information on this important and indispensable tool.

The new book contains a chapter on quantitative measurements which will be of value to the technician and engineer. The basic presentation is much the same as in the earlier edition but the subject matter is much expanded for current usage.

* * *

"COLOR TELEVISION ENGINEERING" by John W. Wentworth. Published by *McGraw-Hill Book Company, Inc.*, New York. 459 pages. Price \$8.00.

This book is an easily-understood explanation of color TV for engineers and technicians already familiar with monochrome TV. It deals with both the physical and psychological aspects of color, colorimetric techniques used in TV, underlying electronic principles, and studio equipment, test equipment, and other devices used in all phases of color telecasting and receiving.

* * *

"INTRODUCTION TO TV SERVICING" by H. L. Swaluw and J. Van Der Woerd. Published by *Philips' Technical Library*, Eindhoven, Holland. 266 pages. Price \$5.50.

Although published in Holland, this book, written in English, will be of value to the service technician in any country which uses the 525 or 625 line standard. It has been prepared especially for those radio service technicians who, having a sound knowledge of circuit fundamentals and practical experience, wish to prepare themselves for TV servicing.

Extensive use is made of illustrations, including photographs of screen pictures as they appear on incorrectly adjusted or faulty receivers, and a detailed description of each fault observed.

* * *

"MATTER AND LIGHT—THE NEW PHYSICS" by Louis De Broglie. Published by *Dover Publications*, New York. 300 pages. Price \$1.60. Paper bound.

This is a translation of a French work originally published in 1937. The volume includes a number of studies on contemporary physics from both the

DeRO the LATEST in electronic equipment

Personna-Tone EXTENSION SPEAKER

High-quality sound for chair-side TV listening. 4x6 speaker. Selector switch and volume controls for TV set. Personna-Tone or both speakers. Wood veneer cabinet. Complete with cable . . . net, \$6.97



All Purpose DeRO-JUVENATOR

One rejuvenator replaces all! Model RU-5—universal 6-wire for use on all series or parallel filament TV sets, both electrostatic and electromagnetic. Restores brilliance and contrast to pix tube . . . net, \$2.35



DeRO-JUVENATOR CRT BOOSTER

New design—compact, one-piece construction. No loose ends, no hanging weights. Model RP-1 for parallel filaments; model RS-1 for series filaments—including electrostatic . . . net, 90c



Dual-Tone VOLUME CONTROL

For radio or TV sound extension. Two volume-control switches—one for each speaker. Volume of either speaker adjusts to any level independently. Ample cable for all cars . . . net, \$2.35



Remo-Tone SWITCH ASSEMBLY

Three-position switch—selects either speaker or both. Silver-plated, non-corroding contacts. Ready for installations. Fits all cars. Instructions . . . net, \$1.17

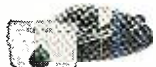

Pic-Test CRT TESTER

Determine instantly if pix tube or set is at fault when TV set won't work. Know CRT condition without removal from chassis. Complete with genuine 6AF6G twin-indicator electron-ray tube . . . net, \$2.97



JOBBER-DEALERS! WRITE FOR DETAILS

DeRO ELECTRONICS

134 NASSAU ROAD
ROOSEVELT • LONG ISLAND • N. Y.

COAXIAL CONNECTORS

83-1J	73	83-168	12	UG-88/U	.65
83-1R	.40	UG-218U	.85	UG-260/U	.65
83-1SP	.40	UG-58U	.65	UG-290/U	.65

RG-8/U COAXIAL CABLE
• 100 ft. \$5.95 • 250 ft. \$13.25 • 500 ft. \$25.00

Brand New TUBE SPECIALS Guaranteed

VR-105	.85	304TL	\$.10	50	866A	\$.12
VR-150	.85	807	.55	872		2.75
211	.75	813	.55	CK1013		2.25
WE 2498	3.75	837	.95	8020		1.00

6SN7GT Brand New. Top quality SYLVANIA
—GE—RCA, etc. 73c



ICA Deluxe Signa-Tone Model 4300

Brand New Audio Oscillator & Code Practice Set. Our Reg. net \$15.75. Price \$7.95

GE 1 RPM SYNCHRONOUS TIMING MOTOR—Wafar thin, 115V-60 Cy, 2.5W \$1.15
HAYDON 4 RPM TIMING MOTOR, 115V-60 Cy, 2.2W \$1.79

SUN BATTERY INT'L RECT 82M output \$1.49
5V 2MA

UTAH PM REPLACEMENT SPEAKERS

4" RB \$1.27 ea. 6" RD \$1.54 ea. 8" RD \$2.77 ea. 10" RD \$3.44 ea.
5" RB \$1.34 ea. 12" RD \$4.08 ea.

STORAGE BATTERIES

BB54A 2V 20 AMP HRS	1.95
NT6 6V 4 AMPS HRS	1.95
EXIDE 7THS-9G 14V Tapped at 6V, 10V 35 AMP HRS. 7 cells	10.95
EXIDE TS-7F 2V cell used in above battery	1.95

TV SERVICE LAMP



- Mounts anywhere; rubber padded spring clamp.
- Swings to any position with 2 ball joints.
- Ideal for inside cabinet work, work bench, or reading light. Comes with 6 ft. cord.
- Less bulb . . . ea. \$1.95

0-15 AMP DC Hoyt Ammeter mirrored scale, knife edge pointer, 12.5 MA movement with self contained shunt, steel case & test leads. . . . ea. \$5.50

SEND FOR FREE BARGAIN BULLETIN

TERMS: Cash with order or 5% deposit—balance C.O.D. Net 10 days to rated acct. All prices net F.O.B. warehouse Market 7-3999

ELECTRONIC DISTRIBUTORS
727-29 ARCH STREET
Philadelphia 6, Pa.

RADIO & TELEVISION NEWS

general and the more metaphysical point of view.

Each of the studies forms an independent whole. Typical studies include matter and electricity, light and radiation, and wave mechanics. There are six "studies" in all.

* * *

"A-M DETECTORS" edited by Alexander Schure. Published by *John F. Rider Publisher, Inc.*, New York. 56 pages. Price \$1.25. Paper bound. Volume 5.

This is the fifth in the current *Rider* series devoted to specific receiver circuitry. Since AM detectors are used in most communications and electronic equipment, a thorough knowledge of their operation is a "must" for the technician.

The text covers AM detector action and then discusses fundamental detector considerations in terms of crystal and vacuum diode, plate circuit, grid-leak, infinite impedance, oscillating, non-oscillating, and superregenerative types of detectors. Linear detection and square law detection are also discussed.

The book includes partial schematics, waveforms, and other pertinent illustrative material which serve to amplify the text material.

* * *

"ELECTRIC NETWORK SYNTHESIS: IMAGE PARAMETER METHOD" by Myril B. Reed. Published by *Prentice-Hall, Inc.*, Englewood Cliffs, N. J. 252 pages. Price \$8.00.

Filter design is approached in this book by first presenting the basic theory of the two-terminal and four-terminal purely reactive network. Practical methods are then presented for correcting the design for dissipation. In analyzing filter design, the technique used is that of obtaining design parameters on the basis of symmetric lattice and using these parameters to create the desired network form. Use of ladder networks in building a filter network is also discussed.

* * *

"VACUUM VALVES IN PULSE TECHNIQUE" by P. A. Neeteson. Published by *Philips' Technical Library*, Eindhoven, Holland. 168 pages. Price \$4.50.

The main aim of this book, written in English, is to indicate how the behaviour of a network in which electron tubes are used as switches can be studied with a view to more efficient use.

After a general discussion on the opening and closing of switches in networks and some principles of operational calculus, there follows a thorough study of the vacuum tube as a switch. The last chapters deal with bistable, monostable, and astable multivibrators.

* * *

"NETWORK ANALYSIS" by M. E. Van Valkenburg. Published by *Prentice-Hall, Inc.*, Englewood Cliffs, N. J. 440 pages. Price \$13.00.

This book presents methods essential for advanced work in network theory, communication systems, servomechan-

isms, computers, and other important areas. A unified treatment of time-domain and frequency-domain concepts is arrived at through the use of the pole-zero method of analysis. This method is also used extensively for interpreting network functions in relation to both transient and sinusoidal steady-state behaviour. For practicing engineers and graduate students.

* * *

"MOST-OFTEN-NEEDED 1956 TELEVISION SERVICING INFORMATION" compiled by M. N. Beitman. Published by *Supreme Publications*, Highland Park, Ill. 190 pages. Price \$3.00. Paper bound.

This timely handbook for the service

technician follows the lines laid down by previous volumes in this series.

Each receiver is pictured and described, with tube locations noted, test points indicated, and special trouble spots called to the service technician's attention. Correct alignment procedures plus a complete schematic of the receiver are also given to insure fast servicing and easy troubleshooting.

This particular volume covers receiver manufacturers by some twenty-four companies. A complete index by make and model or chassis number has been appended to make the location of the correct service information as easy as possible.

-50-

TRU-SONIC

symphony in sound

Sound by Stephens is always noteworthy when selecting the finest in superlative speaker systems. Designed, constructed, and tested by the pioneer sound engineers in high fidelity equipment, the name Stephens stands for true fidelity with music listeners the world over. Each pictured note represents quality speakers and components that will insure the listener a true symphony in sound. Consult your Stephens dealer as to a recommended Tru-Sonic speaker system for your particular needs.

For name of dealer nearest you, write:

STEPHENS MANUFACTURING CORP.
8538 WARNER DRIVE/CULVER CITY, CALIFORNIA

CABLE ADDRESS: "MORHANEX" EXPORT ADDRESS 458 BROADWAY, NEW YORK 13, NEW YORK

KLEINS

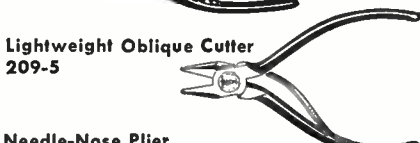
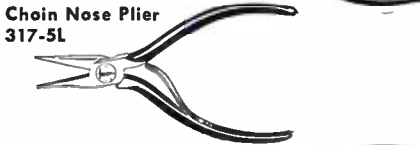

SPECIALY DESIGNED for the ELECTRONICS INDUSTRY

Good workmen everywhere know Kleins, the quality tools of good workmen "since 1857."

Now, genuine Klein Pliers are available in a wide range of styles to meet every need of the electronics industry. May be had with replaceable leafspring to keep pliers in the open position.

Whether on a production line, in the hands of an installer, or for servicing equipment, Kleins will save time, assure a better job.

ASK YOUR SUPPLIER

Foreign Distributor:

International Standard Electric Corp., New York



Write for your free copy of the Klein Pocket Tool Guide today.



Mathias **KLEIN** & Sons
Established 1857 Chicago, Ill., U.S.A.
7200 McCORMICK ROAD • CHICAGO 45, ILLINOIS

Search Tuners (Continued from page 48)

stop the search action of the tuner. (The rise in plate voltage of the first section and grid voltage of the second section is more than offset by an accompanying rise of the cathode voltage of the second section, since all voltages originate from a single "B+" source.) When the relay cuts out, tube voltages are so distributed that the relay remains de-energized until the actuator switch is depressed again.

The action of this circuit suggests a series of tests for troubleshooting. Substitute the trigger tube first since it is the heart of the equipment. Application of a negative voltage to the grid of the d.c. amplifier section of the trigger tube should stop the tuner sweeping action; this simulates an a.v.c. signal and should be about 10 volts. The r.f. signal voltage required to obtain the correct a.v.c. level will vary with the setting of the sensitivity control which the reader will note is a tapped resistance divider completing the cathode returns of the i.f. and mixer tubes.

A quick short to chassis of the relay section cathode should energize the relay—a shunt of 5000 to 10,000 ohms to chassis is preferable to avoid damaging the trigger tube. This will test the relay section and circuit of the trigger tube while the negative voltage applied to the grid of the amplifier section tests both the d.c. amplifier and the relay circuitry.

If the foregoing tests prove the trigger tube circuitry satisfactory, then there remains the questions of a.v.c. voltage and the sensitivity control. The lead to the d.c. amplifier control grid may be removed temporarily and grounded. The set is tuned manually or is allowed to sweep with a high resistance voltmeter monitoring the developed a.v.c. voltage on the lead temporarily removed from the grid of the trigger tube amplifier section. Obviously, an a.v.c. voltage should be developed at various points during the tuning—if not, then servicing should be directed towards restoring this

a.v.c. voltage. This requires more or less conventional servicing techniques.

Assuming there is an a.v.c. voltage, the amount should vary with settings of the sensitivity control. The latter simply cuts in cathode resistance in the i.f. and mixer stages to decrease sensitivity and hence, the a.v.c. voltage. A test of the sensitivity control can be made without checking the a.v.c.; the voltage in the lead to the cathodes should vary as the control is switched. Note that in the "on station" position, only one section of the sensitivity control remains in the circuit being grounded out by one section of the relay switch.

Dirt on any of the several relay points may preclude proper contact and will result in many of the troubles encountered. A light cleaning should be performed early in troubleshooting; as a matter of fact, after trying a new trigger tube. It may clear up the trouble immediately. Then, if the actuator switch (the station selector bar) does not start the mechanism sweeping, it too probably needs cleaning—both contacts, while you are at it!

Fig. 2 also shows the solenoid circuit. This is purely electrical and is readily checked with an ohmmeter, moving the limit switch manually if you wish to check it.

Once the trouble has been localized to a particular section of the trigger tube circuitry, proceed with ohmmeter checks first. Then follow with voltage checks. The voltages indicated in Fig. 2 for this particular model are with the signal not being sought and the relay de-energized.

In conclusion, bear in mind that the mechanism must be made to sweep first and return itself. Then the relay should be checked to stop the sweep mechanically, next the relay section of the circuit is tested or a check is made of the entire trigger circuit with a battery supplying the a.v.c. voltage. Once started to sweep, the device should continue without interruption until the signal on the d.c. amplifier grid stops its action by making the relay armature pull away from its pole piece. Bear these tests in mind and employ them in sequence in servicing signal-seeking tuners.

-30-

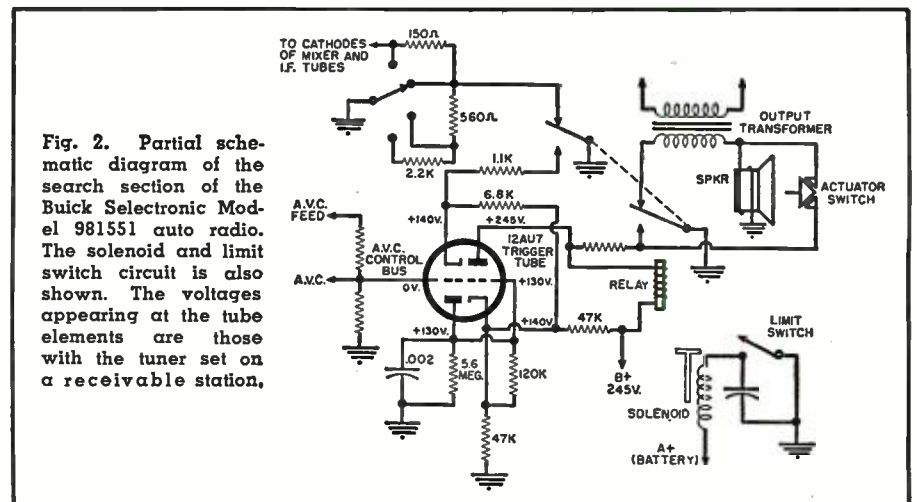

Fig. 2. Partial schematic diagram of the search section of the Buick Electronic Model 981551 auto radio. The solenoid and limit switch circuit is also shown. The voltages appearing at the tube elements are those with the tuner set on a receivable station.

Certified Record Revue
(Continued from page 62)

high and this is one of the best sounding opera records in the entire catalogue. The voices are projected with crisp, clean articulation, all orchestral elements, and especially the great Vienna Philharmonic strings, are heard with outstanding realism. Basically contributory to this is the superb balance Kleiber maintains between the choir, the soloists, and the orchestra. There is an absolute minimum of choral/orchestral "blast" and "fusion." Clothed in the usual spacious London acoustics, wide in frequency and dynamics, this is of the high calibre that all this Mozart activity should be, but which we have scant chance of realizing. For the Mozart fan, this is an absolute "must."

CLEMENTI
SONATAS FOR PIANO IN G MINOR, F MINOR, AND F SHARP MINOR
Vladimir Horowitz, pianist. Victor LM1902. RIAA curve. Price \$3.98.

The LP catalogue is singularly bare of recordings by this great composer. In view of his importance and position in musical history, one might expect better representation than three assorted recordings! It should seem however with a champion like Horowitz the long neglect may soon be remedied. Horowitz has made a particular study of the works of this earliest exponent of the pianoforte, a fact which is audibly evident in his superb readings. Clementi's music is most vital, very robust but not altogether lacking in dignity or gravity. It is fairly common knowledge that Beethoven was considerably influenced by Clementi and a listen to these splendid sonatas will confirm his allegiance to many of Clementi's musical devices.

Horowitz plays these works with verve and obvious understanding. Happily the Victor engineers have abetted him by giving us one of the best solo piano sounds on records. This is big, close-up, full blown recording, entirely appropriate for the music, and literally moving the piano into your living room. Very wide range with similar dynamics, the piano tone is very clean and smooth with nary a trace of ringing or other transient distortions. Admittedly, not everyone will like this repertoire, but if you like piano, give this a whirl.

RAVEL
RAPSODIE ESPAGNOLE
CHABRIER
ESPANA RAPSODIE
IBERT
ESCALES (PORTS OF CALL)
Detroit Symphony Orchestra conducted by Paul Paray. Mercury MG50056. RIAA curve. Price \$4.98.

Here is a very tasty dish, full of delectable musical morsels served up by a masterful chef d'orchestre. It is obvious that Paray has the situation well in hand here, as his readings of these oft-recorded works are the equal of any and are superior to most other versions in the catalogue. His Chabrier is distinguished by its rhythmic drive and propulsive energy. Except for the redoubtable Beecham who has similar ideas, this lack of drive is characteristic of the other versions of "Espana" in the catalogue.

In the Ravel piece, Paray takes advantage of the Mercury "Olympian" technique and exploits the dynamics of the work to the utmost. The result is a reading with unprecedented vitality, quite the most exciting performance, if not the most wholly musical. In the "Ports of Call," he is challenged only by the Stokowski version in matters of inter-

KESTER

KESTER SOLDER COMPANY
4235 Wrightwood Avenue • Chicago 39, Illinois
Newark 5, New Jersey • Branford, Canada

FASTER ACTING
EASIER TO USE
LONGER LASTING
THE BEST

Absolutely non-corrosive and non-conductive, KESTER "RESIN-FIVE" CORE SOLDER contains an activated type of resin that gives you that fast, positive action on all your jobs . . . including the most difficult.

SOLDER

A "DO-IT-YOURSELF KIT"... FOR MAKING MONEY!

Make money with the UNIVERSITY "KwiKit", the speaker enclosure you assemble for your customers and profit 2 ways. Besides assembling the finest kit on the market, every kit leads to the sale of a speaker and components. Best of All—"KwiKit's" unique design enables you to take advantage of the wonderful selling features of P.S.E.—University's Progressive Speaker Expansion Plan for custom building.

Interested? For further information write to Desk L-5.

University LOUDSPEAKERS, INC.
80 So. Kensico Ave., White Plains, N.Y.

GET INTO ONE OF THESE GREATER OPPORTUNITY FIELDS

Electricity or Radio-Television

TRAIN IN THE GREAT SHOPS OF COYNE OLDEST, BEST EQUIPPED SCHOOL OF ITS KIND IN U.S.

Prepare for your future NOW. Get practical training in TELEVISION—RADIO—ELECTRICITY—ELECTRONICS—all vital in Industry. Prepare now for a better job that also offers a real future in the years ahead. Learn on real equipment at Coyne—no advanced education or previous experience needed.

Approved for Veterans—finance plan—enroll now, pay most of tuition later. Part time employment service while training if needed.

FREE BOOK Clip coupon for Big Free Illustrated Book. No Salesman will call. Act NOW.

B. W. COOKE, President **COYNE** FOUNDED 1899
ELECTRICAL SCHOOL
A TECHNICAL TRADE INSTITUTE OPERATED NOT FOR PROFIT
500 S. PAULINA, CHICAGO, Dept. 36-85H
ELECTRICITY • TELEVISION • RADIO • REFRIGERATION • ELECTRONICS

B. W. COOKE, Pres.
COYNE ELECTRICAL School
500 S. Paulina St., Chicago 12, Ill. Dept. 36-85H
Send FREE BOOK and details on:

RADIO-TELEVISION ELECTRICITY

NAME.....
ADDRESS.....
CITY..... STATE.....

MICROTRAN®

PUTS AN END TO ALL LINE VOLTAGE HEADACHES

Insure full size, strength and sync of TV picture when low line voltage shrinks or weakens picture. All units have baked wrinkle finish, built-in AC receptacles and 6' line cord.



NEW! LVS-153 LINE VOLTAGE STABILIZER

A popularly priced, quality automatic voltage regulator. Stabilizes line for TV, radio or industrial use where load is constant. Input may vary between 95-130 volts, nominal output voltage regulated $\pm 3\%$. One model covers 125 to 300 watt range. Built-in automatic relay turns stabilizer on with equipment. Waveshape is free from distortions and frequency sensitivity of resonant type regulators.

Size: 10"x5"x9 $\frac{1}{2}$ " high
Weight: 10 lbs.

List Price: 29.95
DEALER NET: 17.95



NEW! LVB-350 METERED VARIABLE VOLTAGE ADJUSTER

Constant duty unit used as step-up or step-down. Automatically operated—turns on and off with set. Easily adjusted by manually turning 7-position rotary switch until built-in voltmeter reads 115 volts output. Has input switch positions for 90 thru 130 volts.

Watts: 350 Weight: 7 lbs.
Size: 7"x3 $\frac{1}{4}$ "x3 $\frac{3}{8}$ " high
Mounting Centers: 5"x2 $\frac{1}{2}$ "

List Price: 24.75
DEALER NET: 14.85



LVB-117 LINE VOLTAGE BOOSTER

Multi tap selector switch restores line voltages of 90 thru 135 volts to 117 volts output. Calibrated neon indicator permits exact voltage adjustment. Automatically operated—turns on and off with set. Overload fuse protects against unsafe line increases.

Watts: 350 Weight: 4 lbs.
Size: 4 $\frac{3}{8}$ "x3 $\frac{1}{4}$ "x3 $\frac{3}{8}$ " high
Mounting Centers: 2 $\frac{3}{8}$ "x2 $\frac{1}{2}$ "

List Price: 17.95
DEALER NET: 10.80



LVB "Jr" UP-DOWN VOLTAGE BOOSTER

Reliable, budget-priced unit. Single switch provides 10 volt boost or drop or straight-through line.

Watts: 350 Weight: 3 lbs.
Size: 2 $\frac{3}{8}$ "x3 $\frac{1}{4}$ "x3 $\frac{3}{8}$ " high
Mounting Centers: 1 $\frac{1}{16}$ "x2 $\frac{1}{2}$ "

List Price: 6.75
DEALER NET: 4.05



PICTURE TUBE REJUVENATOR

Boosts CRT brightness. Units are resin treated; new design insures cool and buzz-free operation; 8 oz.

List Price

- #48B: Parallel sets, 6 leads \$2.00
- #49C: Parallel sets, 5 leads \$1.50
- #50D: Series sets, 6 leads \$1.75
- #51E: Parallel, isolation, 6 leads \$2.25
- #52 : Parallel, 2-step boost, 6 leads. \$3.75
- #53 : Universal, isolation & boost . . . \$4.25

All the above units are available for immediate delivery at your local distributor

MICROTRAN®

Transformer Division, Crest Laboratories, Inc.
Rockaway Beach 93, New York

pretation. Long a Stokowski specialty, the "Ports of Call" is less sensuous in Paray's hands, but neither does he oversentimentalize, an accusation which has been leveled at Stokowski. In matters of sound Paray has a clear field. This is another *Mercury* hi-fi showpiece, a real stunner! The music, of course, just begs for the all-out hi-fi treatment and the *Mercury* engineers have more than obliged. It is hard to say which is the more spectacular . . . each has its big moments, but if a choice were to be made, I think the "Feria" section of the "Rapsodie Espagnole" is the winner. This is sound fantastic in its clarity and definition, with a dynamic range which is wholly incredible; believe me, the final moments of the "Feria," as played at full room volume on a big speaker, will simply overwhelm you! Awesome bass drum thuds, all other varieties of sharply accented percussion, brazen-voiced brass of great intensity, the rich timbres of the myriad woodwinds, the shimmering fabric and smooth precision of the massed strings . . . all are heard throughout these works, garbed in the widest of frequency response and the most felicitous of acoustics. For those to whom the Ibert work might be a stranger, let yourself listen to it but once and you will fall under its spell as almost everyone else has done. It is supremely beautiful and exciting music and every time I hear it, I get a hard-to-quench urge to chuck everything and go back to sea and the balmier climes!

DEBUSSY
THE BLESSED DAMOZEL
BERLIOZ
SUMMER NIGHTS

Victoria de los Angeles, soprano; Carol Smith, contralto; Radcliffe Choral Society with Boston Symphony Orchestra conducted by Charles Munch. Victor LM1907. RIAA curve. Price \$3.98.

This is an unexpected prize from *Victor*, bringing us the best versions of these lovely works now available. In Debussy's shingly beautiful and reverent work, an old *Columbia* recording with Bidu Sayao and Ormandy and the Philadelphians has been the standard of comparison by which two subsequent recordings were measured and found wanting. Not so in this case, for if anything, los Angeles with her really beautiful voice and depth of feeling is superior to Sayao, to say nothing of the fact that Munch is more at ease with this sort of thing than was Ormandy. Add the splendid sound of this recording before which the older disc is a pale shadow, and you have a thrillingly beautiful musical experience. The same remarks may just as well apply to the Berlioz song cycle, although not quite so strongly. The older recording with Suzanne Danco had much to recommend it, not the least of which was some fine sound from *London*. All things considered however, this recording is preferred as los Angeles is the more convincing and the Boston Symphony has a distinct edge on the Cincinnati group. Beautiful clarity to all the voices throughout both works, including some transparently gorgeous choral work from the Radcliffe group and clean sounding, rich sonorities from the Boston orchestra. Good balances and spacious acoustics help maintain the illusion of presence. Once again, a disc with limited appeal, but highly recommended to those who possess an unprejudiced ear. Fine surfaces in my copy.

BRUCKNER
SYMPHONY #4
WAGNER
SIEGFRIED IDYLL

Vienna Philharmonic Orchestra conducted by Hans Knappertsbusch. London LL1250/1. RIAA curve. Price \$7.98. Two discs.

SURPLUS INDUSTRIAL ELECTRONICS WHOLESALE RETAIL

ARC-5-COMMAND XMTR. 3-4 MC. Brand, Spanking New. Black Wrinkle Finish. R.F.I. (Ready for issue) Condition. The most desirable surplus XMTR at a new low price. Ind. pack. \$25.00 w/all tubes & xtal—\$9.50; 3 for . . .

UHF ARC-5. T-23 (100-156MC) Fair Cond. (no parts missing). Closeout price, ea. \$5.00. With some parts stripped—Good shape—\$7.50 \$2.95; 3 for . . .

ARR-1 UHF Recr.—w/all tubes—Conversion data—New—\$1.95

ARR-2 UHF Recr.—Exc. Cond.—Less tubes \$2.95

BC 457 XMTR—4-5.3 MC }
BC 458 XMTR—5.3-7 MC { Brand New original red label cond. Govt Stamped—latest issue—boxed—New \$6.95

AR-11 Extremely portable OSS Transceiver—Suitcase 12x9x4 Xtal control 4-16 MC—115V. 602 Self power—New \$99.50

Marine Transmitter-Recvr. USCG model TRC-120. Freq. 2000-3500 KC. Power output: 5 watts—Input: 12VDC. Complete w/tubes, cables, handset, vibrapak, xtal. Exc. Cond. \$49.95

CO-AX RELAY-SPDT—Instant cutoff—Energizing voltage may be 12VDC-115VAC—With 2 CoAx connectors—In Alum. Case—\$1.95; 2 for \$3.00

MICRO-AMMETER 0-50 VADC—2 $\frac{1}{2}$ " RD. Hermetic Seal. Ruggedized. Brand New. Latest type—\$5.95; 10 for \$50.00

DUAL RANGE FREQUENCY METER—48-52 and 58-62 Cycles. Double window—100-130 Volts—Mfg. Biddle \$14.95

0-150 VAC—2 $\frac{1}{2}$ " RD. PANEL VOLTMETER \$3.95

NATIONAL TRANSMITTING VARIABLES—New—Boxed

- #TMC-250, 250MMFD—3KV—worth \$14.00 \$2.95
- #EMC-1000, 1000MMFD—1KV—Straight line Freq. \$2.95

SPECTRUM ANALYZER TS-146/UP—Brand New \$195.00

TUBE TYPE 1625—New—Boxed dozen \$2.25

FILAMENT XFORMER—24 Volt—1.5A—Open Frame—Compact—New \$1.95

12 Volt—6A—Cased—Compact—New \$1.95

REX RADIO SUPPLY

88 Cortlandt Street New York 7, N. Y.

TUNERS and CONVERTERS

- POLICE - FIRE
- AMATEUR
- CIVIL DEFENSE
- AIRCRAFT

• 110-170 MC TUNERS and CONVERTERS
• 30-50 MC
net \$15.95 and up

306 B TUNER
• 30-50 meg. band with fixed or variable tuning. Highly stable and sensitive, with exceptional range. Self-contained noise limiter.
6 or 12 volt model. \$2475. net

IMPROVED FM TUNER
• 88-108 MC
to plug in your car
\$22.50 net
write for literature

Kuhn ELECTRONIC PRODUCTS
20 Glenwood • Cincinnati 17, Ohio

London continues its project of recording the Bruckner symphonies and Knappertsbusch does as well here as he did with the third symphony last year, but whereas in the third symphony he had virtually no competition on discs, here he runs right into the formidable Otto Klemperer on Vox. Klemperer's reading was most highly regarded and rightly so for the honesty of his interpretation and understanding he brought to the score. In all truth I cannot say Knappertsbusch's reading is superior; but it is at least its equal. One virtue balances the other's fault . . . Klemperer is guilty of overstatement at times, Knappertsbusch is a little too inflexible in his phrasing. It is suggested that those individuals who maintain an aloof isolation from Bruckner's music listen to this recording. You will find here a much warmer, more human Bruckner who knows how to laugh and love.

Biggest point of superiority and the reason why this is the recording of choice is the vast difference in sound quality between this disc and the older Vox disc. Here is typical full-blown, big-hall London sound, with all instruments superbly clean and perfectly balanced in the proper acoustic perspective. In the "Siegfried Idyll," Knappertsbusch is up against even stiffer competition from Furtwangler and Toscanini, but comes off very well in spite of this. Probably this point is heightened by the fact that this sound is so superior to the other recordings. A very smooth, almost luminous sound, this is well adapted to the score. Except for some excessively slow tempi Knappertsbusch plays it straight if not overly inspired. Summing up, I would say that the Bruckner is a valuable addition to the catalogue and with its splendid sound should be enjoying new popularity.

MOUSSORGSKY

KHOVANTCHINA (COMPLETE)

Soloists, chorus, and orchestra of the National Opera (Belgrade) conducted by Kreshimir Baranovich. London XLLA-29. RIAA curve. Price \$19.92. Four discs.

Only a company with the vast resources of London could make and would undertake to produce such a huge work as this "Khovantchina," in spite of the obvious fact that the market in the U.S. would be quite limited. However it was brought about, many people will be in London's debt. This work has never gained the popularity of "Boris" even in Russia, but there is much in it that is very beautiful and very interesting. Of course, a staple of the concert hall for years has been the lovely "Prelude." This is a behind-the-Iron Curtain project and that makes the recorded quality all the more remarkable. The opera seems to be handsomely performed by the National Opera in Belgrade which has several fine singers in the persons of bass Tzveych and tenor Startz. The choral and orchestral work is quite good . . . a few flurps here and there, raggedness in the ensembles on attacks are minor falls from grace. General sound quality is good with fine clean string and woodwind tone, punchy brass, heavy accurate percussion, and excellent acoustics. Frequency range and dynamics are quite wide and groove distortion was minimal. As I remarked about the previous "Prince Igor," if you can afford it, you won't go wrong as it is extremely unlikely there will be any duplications on this item!

MOZART

COSI FAN TUTTI (COMPLETE)

Elisabeth Schwarzkopf, Nan Merriman, Rolando Panerai, Leopold Simoneau, and others with Philharmonia Orchestra and Chorus conducted by Herbert von Karajan. Angel 3522C. RIAA curve. Price \$15.96. Three discs.

As I said before, Mozart and more Mozart!

March, 1956

FREE! BA'S NEW 1956 CATALOG

YESSIR-IT'S THE KING-SIZE CATALOG
164 "KING-SIZED" (8 1/4 x 10 1/2) PAGES
OFFERS MORE ITEMS PER PAGE--IT'S EASIER TO USE...IT'S EASIER FOR YOU TO ORDER

COMPLETE GUIDE TO EVERYTHING IN RADIO, TV, ELECTRONICS

100'S OF BRAND NEW ITEMS LISTED HERE FOR THE VERY FIRST TIME

INCLUDES 21 BIG PAGES OF BARGAINS NOT FOUND IN ANY OTHER CATALOG

A Complete Buying Guide for Everything in RADIO TELEVISION ELECTRONICS

Guarantee
 We guarantee everything in our Catalog to be of the quality and value represented. If you are not completely satisfied, we will refund your money. No questions asked. This guarantee is valid for each purchase.

for

DEALERS, SERVICE MEN, SCHOOLS, BROADCASTERS, INDUSTRIALS, THEATRES, MANUFACTURERS, CHURCHES, HOTELS, PUBLIC UTILITIES, EXPERIMENTERS, ENGINEERS, LABORATORIES, AMATEURS

BURSTEIN-APPLEBEE CO.
 1012-14 McGEE ST., KANSAS CITY 6, MISSOURI

RUSH COUPON FOR THIS BIG CATALOG NOW!

Send Free B-A Catalog No. 561.

NAME _____

ADDRESS _____

CITY _____ STATE _____

CROWN

a name and a product you can rely on in TV antenna rotation—

Crown Tenn-A-Liner Rotators—proven top performers with an exceptional record in consumer acceptance and outstanding dependability. Beautifully styled for greater sales appeal . . . only 1.06% of all units sold require service . . . a unique performance record. All this . . . PLUS the highest profits in the field . . . make Crown your best buy in TV antenna rotators.

CROWN CONTROLS Co., Inc. NEW BREMEN, OHIO

Canadian Subsidiary Crown Controls Mfg. Ltd. Export Division, 15 Moore St., New York, N. Y., Cable "Minthorne"

Say.....

As the manufacturer of the **Karlson Enclosure** and a high fidelity hobbyist of appalling proportions it has been a source of constant amazement to me that everyone hasn't finally "discovered" the **Karlson** yet. By now almost everyone has heard about it, so what is the holdup? Even some people who heard the unit at the various audio shows have not yet bought one!

Is the **Karlson** good? Ask **anyone** who has one! Ask the governors of five states (Connecticut, for instance). Ask any of the accepted hi-fi authorities. Ask C. G. Burke (who reviews records and hi-fi equipment for the Saturday Review and High Fidelity magazine). He has had his **Karlson** for over two years and absolutely refuses to part with it. Write to the Audio League for their bulletin which presents the results of exhaustive tests and lavishly praises the **Karlson**. We have a huge file of testimonial letters, the like of which has never before been seen by a high fidelity manufacturer, and we have yet to receive a complaint which could not be simply and easily fixed by the correction of some small mistake, usually in the installation of the speaker.

So there is the positive side of the story. What about the other side? How come so many people have yet to buy a **Karlson**? Right now we are selling about 1400 **Karlsons** a month, how come it isn't 14,000? That is something you can tell me, maybe. How come you haven't bought a **Karlson** Enclosure? Is it that you haven't read our 32 page booklet? We have distributed some 100,000 of them so you certainly should have had one by now.

How about dropping me a line and telling me how come you are still staggering along with a half hi-fi system. I'll at least send you one of my booklets in return. If you've got some good reason for not buying a **Karlson** have a heart and let me know what it is. If you haven't, then let me send you the reasons why you should.

Best of all, of course, is for you to hie yourself down to the local scratch and boom emporium and sidestep the brain-washing long enough to give a careful ear to what the **Karlson** can do.

Wayne Green, Vice President
Karlson Associates, Inc.
Dept. NSD, 1610 Neck Road
Brooklyn 29, New York

GET INTO ELECTRONICS

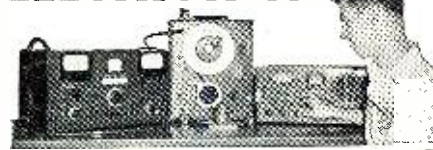

You can enter this uncrowded, interesting field. Defense expansion, new developments demand trained specialists. Study all phases radio & electronics theory and practice; TV; FM; broadcasting; servicing; aviation, marine, police radio. 18-month course. Prepare for good pay. Graduates in demand by major companies. High School or equivalent required. Begin January, March, June, September. Campus life. Write for catalog.
VALPARAISO TECHNICAL INSTITUTE
Dept. RD Valparaiso, Indiana

Where will it end? Not that this album is something to decry . . . far from it! It is just that I think you can overdo this commemorative business. This recording is all that the devoted Mozart fan could desire. Schwarzkopf sings gloriously her role of Fiordiligi, Nan Merriman is a convincing and silver-voiced Dorabella, Simoneau is his usual superbly confident self as Ferrando, Panerai, better here than in some other roles of recent memory, is Guglielmo, Lisa Otto makes an attractive Despina, and Bruscantini carries off his role of Don Alfonso with great zest. Von Karajan, often accused of being a "cold" conductor, is anything but that in this recording. In fact his excellently conceived and beautifully integrated reading is one of the major contributions to the success of this album. He has a "just right" sense of timing and he uses it with dramatic effect. With the splendid singing and conducting, the fact that this is also the best sounding version available, comes as a not totally unexpected but nonetheless pleasant plus. The Philharmonia, as sweet-sounding a group as ever graced a record, and all the vocal elements are recorded with wide frequency response and good dynamics, with little if any distortion in evidence. Acoustics are appropriate and all this fine production was made still more attractive by packaging it in a handsome album with blue moire covers.

BEETHOVEN SYMPHONY #4 AH PERFIDO (ARIA)

Elizabeth Schwarzkopf, soprano, with Philharmonia Orchestra conducted by Herbert von Karajan. Angel 35203. RIAA curve. Price \$4.98.

The Beethoven 4th is here given its 17th version on LP! As Beethoven's least popular symphony this an amazing number of duplications. Von Karajan is not wholly sympathetic to the demands of this work and his reading is a little on the "cool" side. A rather humorless perusal of an essentially lyrical and charming work. To make up for the shortcomings in performance however, we have the best sounding 4th now available. The superb precision of the Philharmonia strings is heard with smoothly edgeless, almost transparently clean, sound, all other orchestral elements are equally well recorded.

The prize on this disc is "Ah Perfido," sung with unsurpassable beauty by the lovely Schwarzkopf. Her intonation and personal warmth impart a deeply expressive aura of presence aided and abetted by spacious, but not overdone acoustics. If sound is your principal criteria, you won't go wrong on this 4th, and the "Perfido" is worth the price of the record in any case.

Jazz Corner

BEST COAST JAZZ
EmArcy MG36039. RIAA curve. Price \$3.98.

This disc derives its odd name from the fact that talent from both East and West Coasts were recorded together. As personnel on this record are some of the real hot men in jazz today, let's see who is blowing. Well, the ubiquitous Clifford Brown is on the trumpet and his buddy Max Roach is on the traps, Herb Geller is on alto sax, Joe Maini, Jr. is on alto and tenor sax, Walter Benton on tenor sax, Kenny Drew, piano, and Curtis Counce, bass. There are but two numbers on this disc . . . "Coronado" on one side and "You Go to My Head" on the other. As you may have guessed this is the disc for you cats that like jam sessions for that's what happens for over 15 minutes on each side. As is usual, there is a certain amount of ensemble work and then the individuals take off in their solo rides. Believe me, with this much time devoted to one number, the rides are frantic

Rid Your Records of Dust

always use

STATIC masters®

The Best...The Dry Method



**NO SPRAYING
NO WASHING
NO RUBBING**

Brush while
record is rotating

The
Polonium
Strip does
the trick

An effective easy-to-use record brush that will pay for itself many times over—in the protection it will give your prized record collection.

\$17⁸⁵

Expensive compared with other products...but inexpensive when noise-free and longer lasting records are considered.

Buy **STATICMASTERS** at your Hi-Fi dealers or order direct...sent postpaid—cash with order.

NUCLEAR PRODUCTS CO.
10173 E. RUSH ST. • EL MONTE, 2, CALIF.



POCKET UTILITY PROBE

PR-200

- Series Filaments
- Parallel Filaments
- Electronic Components



\$3.25

LIST
Complete
with Instructions

TUBE TESTER CONTINUITY TESTER

Rapid positive tests for SERIES and PARALLEL filaments in all types of TELEVISION, A.C.-D.C. RADIOS and PORTABLES. Tests all types of tubes, OCTAL, LOCTAL, 7 PIN MINIATURES, 9 PIN MINIATURES and CATHODE RAY TUBES. Continuity tests can also be made on all types of electronic components, appliances, electrical and automotive equipment. Unlike most series filament and continuity testers, the PR-200 Pocket Probe is designed to easily fit the serviceman's pocket and tool box. The PR-200 probe is entirely shock-proofed and utilizes any 110V. AC-DC line.

EBY SALES CO. of N. Y.
130 LAFAYETTE STREET
NEW YORK CITY 13, N. Y.

RADIO & TELEVISION NEWS

and each man has more than ample opportunity to blow his head off! These boys are all good, but the standout to my ear was Clifford Brown. As usual the *EmArcy* sound was fantastic.

This *EmArcy* stuff is the best possible way of testing the transient response of your speaker. Recorded very close-to, it's like having a pipeline into the studio. The results are sensational from the breathy "sputteriness" of the saxes, the crisp plunk of the bass, the sharp rap of the traps, and the brassy brazen clangor of the trumpet. Super wide in frequency response, with enough reverb to add liveness but not obscure detail. In spite of some of the tremendous leading waves on some of the hard-blown transients, no pre- or post-echo is in evidence.

Tape Review

BACH, J. S.

**TOCCATA IN D MINOR
TOCCATA IN E MAJOR
TOCCATA IN F MAJOR**

Carl Weinrich on the organ of Varfrukyrka at Skanninge, Sweden. Sonotape SW1011. 7½ ips, dual-track, NARTB equalization. Price \$7.95.

This tape is one of a group of twelve initially released by *Sonotape*, which is evidently a subsidiary of the *Westminster* company. Sold only by mail at present, these tapes are for the most part taken from the master tapes of previously released *Westminster* records. This organ tape happens to be an exception to this as it was released before the disc. The entry of *Westminster* into the tape field will engender much enthusiasm as this company has long been noted for the quality of its recordings. I can say this . . . if the quality of all *Sonotape* releases is as good as this, a lot of people are going to re-evaluate their thinking about recorded tape.

This is just about the finest organ recording I have yet heard. The repertoire is well chosen, and the performances are magnificent. Weinrich stays strictly on the classic line, with careful attention to tempi, phrasing, and registration. The famous "D Minor Toccata," often grotesquely romanticized beyond all good taste, is heard as it should be, cleanly and crisply delineated, with all of the various voices completely articulate. The other toccatas are similarly treated. The organ used is an instrument in a Swedish church, which was reconstructed along modern classic lines, but retains some of the old baroque voicings. The church is ideal acoustically with a reverberation period long enough to lend the music the desired spaciousness, but short enough so that all the voicings retain their maximum clarity and definition.

Throughout the tape, there has been no attempt to strive for hi-fi effects such as overblown pedals, etc. Much of the superiority of the sound lies in the fabulous clarity and balance. This is what I would call believable hi-fi organ sound, so scaled that in an average living room it does not seem out of proportion.

Frequency response and dynamic range are very wide, distortion was not at all apparent. Tape hiss was at such a low level as to be unobtrusive, but there were certain occasional thumping sounds which might be attributable to the organ. All in all, a superb tape from every aspect. Such quality at the reasonable price will make these tapes very popular and this could cause *Sonotape* some troubles with delivery, inasmuch as their dubs are made on a straight machine-to-machine basis with no speed-up! It would seem that to satisfy demand they would have to utilize a multi-speed process such as the *Ampex*, or a multi-dub common mandrel system. More of the *Sonotape* output will be reviewed later.

Some new stereotapes are also on tap for next month, so watch for them!

FOR HIGH PROFIT ...and Little Competition... GET INTO MOBILE-RADIO MAINTENANCE

Wherever you see the tell-tale vertical antenna . . . on cars, trucks, or taxis . . . atop a building or mast . . . it's your tip-off . . . these outfits require first-rate, regular, radio maintenance . . . and they pay high profit!

LAMPKIN METERS ARE THE PREFERRED TEST EQUIPMENT!



LAMPKIN 105-B MICROMETER FREQUENCY METER
Heterodyne type. Range 0.1 to 500 MC., all channels. Pinpoint VHF CW signal source. Weight 13 lbs. Width 13". Price \$220.00 net.

LAMPKIN 205-A FM MODULATION METER
Indicates peak voice deviation, ± 25 KC. Tunes 25-500 MC. in one band. Speaker. Oscilloscope output. Relative field-strength meter. Weight 13 lbs. Width 12". Price \$240.00 net.



Ask for our booklet "HOW TO MAKE MONEY IN MOBILE RADIO MAINTENANCE". Do it NOW! There's no charge.

LAMPKIN LABORATORIES, INC.
MFM Division, Bradenton, Florida

At no obligation to me, please send booklet "How to Make Money in Mobile-Radio Maintenance"

Name _____
Address _____
City _____ State _____

LAMPKIN LABORATORIES, INC.
MFM Division Bradenton, Florida

SAVE HOURS OF WORK

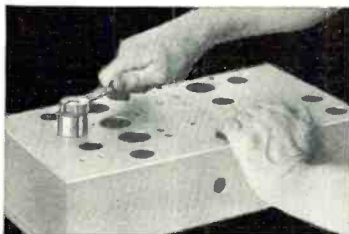

quickly make round, square, key and "D" openings with Greenlee Radio Chassis Punches

In 1½ minutes or less you can make a smooth, accurate hole in metal, bakelite or hard rubber with a GREENLEE Punch. Easy to operate . . . simply turn with an ordinary wrench. Wide range of sizes. Write for details. Greenlee Tool Co., 1883 Columbia Ave., Rockford, Ill.

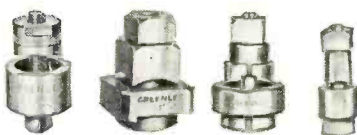

DON'T THROW OLD RADIOS AWAY!

Here's the data you need to fix them FAST . . . and good as new!

Just look up the how-to-do-it data on that old radio you want to fix!

Four times out of 5, this giant, 3½-pound, 744-page Ghirardi RADIO TROUBLESHOOTER'S HANDBOOK gives exactly the information you need to fix it in a jiffy. Tells what is likely to be causing the trouble . . . shows how to fix it. No useless testing. No wasted time. Handbook covers practically every radio receiver model made by 202 manufacturers between 1925 and 1942. Using it, even beginners can easily fix old sets which might otherwise be thrown away because service information is lacking. With a few simple repairs, most of these old sets can be made to operate perfectly for years to come.

THE ONLY GUIDE OF ITS KIND!
Cuts service time in half!

Included are common trouble symptoms and their remedies for over 4,800 models of old home, auto radios and record changers. Airline, Apex, Arvin, Atwater Kent, Belmont, Bose, Brunswick, Clarion, Crosley, Emerson, Fada, G-E, Kolster, Majestic, Motorola, Philco, Pilot, RCA, Silver-tone, Sparton, Stromberg and dozens more. Gives how-to-do-it data on SPECIFIC jobs—NOT general theory. Includes hundreds of pages of invaluable tube and component data, service short cuts, etc.

.....TRY IT 10 DAYS . . . at our risk!.....
Dept. RN-36 RINEHART & CO., Inc.
232 Madison Ave., New York 16, N. Y.

Send Ghirardi's RADIO TROUBLESHOOTER'S HANDBOOK for 10-day free examination. If I decide to keep book, I will then remit the full price of only \$6.50 plus a few cents postage. Otherwise, I will return book postpaid and owe you nothing.

NAME _____
ADDRESS _____
CITY, ZONE, STATE _____

OUTSIDE U.S.A.—Price \$7.00 cash with order only. Money back if book is returned in 10 days.

Rinehart Books are sold by leading book stores

WE'RE TAKING INVENTORY

You take the BARGAINS



UTAH 12" COAXIAL SPEAKER

12" woofer, 3 1/2" tweeter ideal for any custom installation.
List Price \$25..... **\$11.50**

Pocket Size TRANSISTOR RADIO

Plays anywhere, works on flashlight batteries. Complete ready to use.

\$8.50

Now

TOP QUALITY TUBES

• Individually boxed • One year RTMA guarantee • Best Brands Available

Type	Price	Type	Price	Type	Price
OZ4	.45	6H6GT	.40	6A7	.59
1B3GT	.79	6J4	2.00	6A8	.59
1L4	.51	150T	.40	6AB4	.45
1L6	.51	6B6	.49	6AF4	.80
1LA4	.57	6J7	.45	6AG5	.72
1LB4	.66	6K6GT	.39	6AH6	.80
1LC6	.66	6K7	.40	6AK5	.80
1LD5	.57	6L7	.44	6AL5	.42
1LE3	.57	70C	.45	6AL7GT	.70
1LG5	.57	78F	.70	6AS5	.50
1LH4	.66	7Y4	.35	6AS6	2.00
1LN5	.47	12AT6	.41	6AS7G	2.25
1N5GT	.55	12AT7	.68	6AT6	.40
1R4	.66	12AU6	.46	6AUSGT	.70
1R5	.51	12AU7	.58	6AU6	.43
1S4	.59	12AV6	.42	6AV5GT	.75
1S5	.51	12AX7	.63	6AX5GT	.59
1T4	.51	12AY7	.90	6B4G	.90
1U5	.50	12BA6	.46	6BA6	.49
1V	.57	12B4	.70	6BC5	.50
1Z2A	.62	12BE6	.46	6BE6	.46
2021	1.00	12BH7	.60	6BG6G	1.18
2V3G	.80	12B7V	.64	6N7	.61
2X2A	.90	12SA7	.52	6Q7	.45
306	.45	12SH7	.47	6S4	.48
3I4A	.69	12SK7GT	.50	6S7G	.47
6B6	.53	12SL7GT	.60	6SA7GT	.50
6B6	.49	12S7GT	.57	6S7	.50
6BK5	.70	12SQ7GT	.40	6SG7	.43
6BK7A	.78	14A5	.59	6SH7	.45
6BN6	.59	14A7	.45	6SJ7GT	.45
6BL7GT	.77	14B6	.40	6SK7	.50
6BQ6GT	.80	1407	.52	6SL7GT	.70
6BQ7A	.80	19BSSG	1.18	11N7GT	.39
6BZ7	.90	304	.55	6SQ7GT	.44
6BY6G	.60	305GT	.63	6V6GT	.48
6C4	.39	3V4	.58	6W4GT	.40
6C5	.36	5T4	.70	6W6	.60
6C6	.50	5U4G	.49	6W6GT	.53
6CB6	.51	5V4G	.71	6X4	.35
6CD6G	1.18	5V3GT	.89	6X5	.39
6D5	.50	5Y4G	.43	6X5GT	.35
6E5	.46	5Z3	.45	6X8	.75
6F6	.40	5Z4	.54	6Y6G	.60

Dumont and RCA licensed CATHODE TUBES

• All brand new • One year guarantee • Discounts for the Quantity Purchaser

Type	List Price	Price	Type	List Price	Price
10BP4	\$14.25	\$11.99	6S7	\$3.00	\$18.00
12LP4	14.25	14.99	19AP4	48.75	23.00
14BP4	26.50	15.99	20CP4	39.00	24.00
16EP4	34.25	27.99	21FP4	40.75	24.00
16LP4	41.25	19.99	21FP4	40.75	24.00
17BP4	32.00	19.00	16GP4	44.75	19.95

FREE ELECTRIC TESTER

equipped with genuine neon glow lamp. Test loads from 50 to 500 volts, AC or DC. With every \$3 or more ordered.

COUPONS

Reg. \$4.95 5 pc. SYLVANIA REPAIR KIT

with every order. Send for free premium catalog... order now... get these valuable coupons.

Inc. flashlight head, Phillips and flat head screwdrivers, alignment tool and case, with every order of \$25 or more.

Write for Stanley's Tube & Parts Catalog!

16 ELEMENT TV ANTENNA KIT Double bay conical with 2-5 ft. mast sections, wire and hardware. List price \$21.50... \$13.50	WELLER DUAL LITE SOLDER GUN KIT 100 watt gun, with dual spotlight, solder, brush and soldering aid... \$5.83
---	---

TERMS: 25% deposit required on all orders, balance COD. Save COD charges send full remittance plus postage with order. All unused money refunded with order.

NO MINIMUM ORDER. SUBJECT TO PRIOR SALE.

Stanley ELECTRONICS CO

935 MAIN AVENUE - PASSAIC, N. J.

DEPT. RN-356

Gregory 1-2498

170



TV TUBE CHART

In order to expedite the selection of the correct TV picture tube replacement, the Sales Department, *Haydu Brothers*, Plainfield, New Jersey, has compiled a handy wall chart especially for distributors, dealers, and service technicians.

The chart, which is printed in two colors, lists every popular type of picture tube now being produced by TV manufacturers plus the corresponding *Haydu* tube type. Tube types and a description of face type, external conductive coating, and ion trap magnet are listed for all tubes.

The chart can be folded and carried in the technician's kit or mounted on the wall for quick reference.

TODD-TRAN DATA

Todd-Tran Corp., 156 Gramatan Avenue, Mount Vernon, New York is now offering replacement guides for *Philco*, *Admiral*, *CBS*, and *Emerson* television receiver lines.

These data sheets are complete and up-to-date and list all of the company's authentic replacements of the original manufacturers' yokes and fly-backs.

Copies of any or all of these data sheets are available to the trade without cost upon written request.

COMMUNITY TV

A 16-page booklet discussing the future of community television has been printed by *Entron Incorporated*, P. O. Box 287, 4902 Lawrence Street, Bladensburg, Maryland, consulting engineering firm.

Available without charge, the new publication explains the physical setup of community television, describes the need, and then takes up the public service and profit aspects of this fast-growing industry.

CABINET BROCHURE

Stan White Inc., 725 South LaSalle Street, Chicago 5, Illinois has just released a four-page brochure covering its line of high-fidelity speaker systems.

The booklet pictures and describes the firm's new "4-D" system, "The Millennium" and "The General" enclosures in the upper price bracket and the "Opus I," "Le Sabre," "Esquire," and "Hi-Fi" in the moderate price class. All pertinent technical and physical specifications are given for each of the cabinets.

RECTIFIER REPLACEMENTS

A new 28-page selenium rectifier replacement guide has just been published by the Semiconductor Division

of *Radio Receptor Co., Inc.*, 251 West 19th Street, New York 11, New York.

This up-to-date, pocket-size manual lists the company's specifications and replacement requirements for all radio and TV sets using rectifiers. In addition, it features a cross-reference of the company's rectifiers with competitive types.

Copies of this guide are available by writing to Department E of the company.

SYLVANIA TV PICTURE TUBES

The Television Picture Tube Division of *Sylvania Electric Products Inc.* has announced the release of a new version of its annual booklet, "Characteristics of *Sylvania* Television Picture Tubes."

The new 24-page booklet is available free from the company's Central Advertising Distribution Dept., 1100 Main Street, Buffalo 9, New York. Picture tubes and other cathode-ray tubes listed in the new booklet include those of all domestic manufacturers as well as several types of foreign manufacture.

The characteristics and typical uses of standard phosphors are presented in tabular form along with other data useful to distributors, dealers, and service technicians.

CAPACITOR CATALOGUE

Plastic Capacitors, Inc., 2511 W. Moffat Street, Chicago 47, Illinois has just released a new catalogue which provides complete data on its line of paper capacitors for a.c. and d.c. applications.

Catalogue #155 includes data on mineral oil impregnated paper dielectric capacitors in a variety of containers, synthetic oil impregnated paper dielectrics, "Aroclor-AC" capacitors, etc. Information includes charts, diagrams, technical information, part number, capacity, etc.

NEW BUD CATALOGUE

Bud Radio, Inc., 2118 East 55th Street, Cleveland 3, Ohio has announced the availability of a new catalogue which illustrates and describes its entire line of sheet metal products and electronic components in addition to special fabrication facilities available at the plant.

To insure ease of selection and ordering, complete sizing information is given on each product. Suggestions for uses and applications are also included.

The catalogue will be sent without charge if requests are addressed to Dept. C11 of the company.

TUBE INTERCHANGEABILITY

A new edition of the company's well-known booklet on the interchangeability of power tubes used in broadcasting and industry has been announced by the Tube Department, *General Electric Company*.

Broadcast and industrial technicians will find this condensed edition (ETL-719B) a time-saver in selecting inter-

changeable tube types. A new feature of the book is a listing of the 282 tube types in alphabetical and numerical order instead of by manufacturer. The list includes all types of power tubes for which G-E has a direct replacement.

The new edition is available from the company's tube distributors.

ASA ELECTRICAL STANDARDS

"The 400 American Standards in the Electrical Field" is the title of the new 60-page booklet, which indexes and describes each ASA standard in the electrical engineering area, just released by the American Standards Association, 70 East 45th Street, New York 17, New York.

Available without charge as long as the supply lasts, the booklet gives briefs on each of the current International Electrotechnical Commission recommendations, a listing of all projects under the jurisdiction of the Electrical Standards Board, and general information on the work of the ASA and the other two groups.

HIGH-TEMPERATURE RECTIFIERS

The Rectifier Division of *Sarkes Tarzian, Inc.*, 415 North College Avenue, Bloomington, Indiana is now offering a four-page bulletin, HT-1, covering its full line of high temperature selenium rectifiers which are capable of operating at plate temperatures of 150 degrees C without derating.

The bulletin shows ratings and characteristics of these new components. It is available without charge on written request.

1956 TOOL CATALOGUE

Vaco Products Company, 317 E. Ontario Street, Chicago 11, Illinois has just issued a colorful and comprehensive catalogue covering its line of tools for the electronic industry.

This 40-page handbook has been designed to serve as a guide, ready reference, and sales builder for dealers and jobbers in industrial, automotive, electronics, refrigeration, electrical, hardware, and allied fields.

Complete specifications are given on the firm's line of screwdrivers, nut drivers, wood chisels, pliers, kits, specialty tools, plastic mallets, and a variety of its "Vari-Board" merchandising displays and tool assortments.

LANGEVIN DATA

Langevin Manufacturing Corporation, 47-37 Austell Place, Long Island City 1, New York has just issued a two-color, four-page brochure covering its line of transformers and reactors; broadcast amplifiers; miniature and subminiature components for radio, radar, computers, and automation; power supplies; and various items of audio equipment.

Copies of the publication, "Custom-Built by *Langevin*," will be forwarded without charge upon request.

TRANSISTOR-RECTIFIER DATA

The Semiconductor Products Section, *General Electric Company*, Elec-

MONTH AFTER MONTH . . . ALL YEAR 'ROUND—



SERVICE ARTICLES KEEP YOU POSTED—

HELP YOU TO BIGGER PROFITS!

While this is our Special Service Feature Issue, every issue of RADIO & TELEVISION NEWS brings you up-to-the-minute, practical and authoritative service articles.

Below, for example, are just a few of the outstanding service features which have appeared in past issues. These and all other RADIO & TELEVISION NEWS servicing articles are designed to provide you with a wealth of expert know-how . . . keep you in the forefront of qualified servicing personnel—in TV, both black-and-white and color, radio, Hi-Fi and audio equipment.

- CBS-COLUMBIA TEST POINTS
- D. C. TV INSTALLATIONS
- NEW TV CIRCUITS FOR 1956
- G-E TEST POINTS
- EMERSON TEST POINTS
- MOTOROLA TV TEST POINTS
- REPAIRING STANDARD COIL TUNER
- SERVICING COLOR TV
- RCA COLOR RECEIVER
- MOTOROLA COLOR RECEIVER
- MODULES IN TV RECEIVERS
- TRANSISTOR RADIOS
- ANTENNA NEWS
- MAC'S SERVICE SHOP

THERE'S NO BETTER WAY TO KEEP UP WITH WHAT'S NEW IN SERVICING
THAN THROUGH THE PAGES OF RADIO & TELEVISION NEWS.

SUBSCRIBE TODAY!

USE THE HANDY ORDER FORM FACING THIS PAGE

don't
be
vague...

insist on
**SPRAGUE
BLACK
BEAUTY®**



T L E C A P®
tubulars

SPRAGUE

NORTH ADAMS, MASS.

ELECTRIC BRAIN KIT

Can you think faster than this Machine?

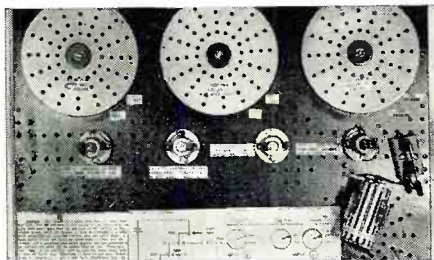

Control Panel of GENIAC set up to do a problem in check valve research.

Be careful before you answer. GENIAC the first electrical brain construction kit is equipped to play tic-tac-toe, cipher and encipher codes, convert from binary to decimal, reason (in syllogisms) as well as add, subtract, multiply and divide. Specific problems in a variety of fields—actuarial, policy claim settlement, physics, etc., can be set up and solved with the components. Connections are solderless and are completely explained with templates in the manual. This covers 33 circuits and shows how new ones can be designed.

You will find building and using GENIACs a wonderful experience; one kit user wrote us: "this kit has opened up a new world of thinking to me." You actually see how computing, problem solving, and game play (Tic-tac-toe, nim, etc.) can be analyzed with Boolean Algebra and the algebraic solutions transformed directly into circuit diagrams. You create from over 400 specially designed and manufactured components a machine that solves problems faster than you can express them.

Schools and colleges, teachers of science or math, engineering, philosophy or psychology will find these excellent demonstrations of circuitry, solutions in symbolic logic, theory of numbers, cybernetics, and automation.

Note: Teachers take advantage of our 10% discount to educational institutions and for group purchases.

SEND for your GENIAC kit now. Only \$19.95 with over four hundred components and parts, fully illustrated manual and wiring diagrams. We guarantee that if you do not want to keep GENIAC after one week you can return it for full refund plus shipping costs.

MAIL THIS COUPON

SCIENCE KITS, Dept. RT-36, Oliver Garfield Co.
126 Lexington Ave., N.Y. 16, N.Y.

Please send me:

- 1 GENIAC Electric Brain Construction Kit and Manual.
- \$19.95 (East of Mississippi)
- \$20.95 (Elsewhere in United States)
- \$21.95 (Outside the United States)

Returnable in seven days for full refund if not satisfied. I enclose \$..... in full payment. My name and address are attached.

172

tronics Park, Syracuse, New York has just issued a new eight-page brochure especially for engineers and hobbyists.

The new booklet contains condensed specification and rating data on transistors and rectifiers. Critical parameters for absolute maximum ratings and design center ratings are given for the complete line of *G-E n-p-n* and *p-n-p* transistors currently in production.

In addition, critical specifications for the company's complete germanium rectifier line, including basic rectifier units, high temperature rectifiers, magnetic amplifier rectifiers, rectifier stacks, 5-amp. power rectifiers, and medium power rectifier stacks in various applications are given.

AUDIO WIRE

Alpha Wire Corp., 430 Broadway, New York 13, New York has just announced publication of Catalogue S-55 covering its complete in-stock line of some 145 items for audio applications.

The publication contains descriptions, specifications, and illustrations of the products along with prices on the listed items. Copies of this catalogue are free upon request to the company.

1956 EICO CATALOGUE

Electronic Instrument Co., Inc., 84 Withers Street, Brooklyn 11, New York has just published a new 12-page catalogue which pictures and describes some 54 instruments in the *Eico* test equipment line.

The catalogue describes the features, applications, and specifications for each model including kit and factory-wired prices. It includes such units as oscilloscopes, v.t.v.m.'s, multimeters, signal and sweep generators, tube testers, signal tracers, resistance and capacitance boxes, accessory probes, and high-fidelity amplifiers.

Copies of this new catalogue are available without charge either from the firm's distributors or from the company direct.

TV TUBE WALL CHART

The TV Picture Tube Division of *Sylvania Electric Products Inc.* has just released a new version of its handy "TV Picture Tube Comparison Chart."

The new wall chart, revised and brought up-to-date, is available without charge and is obtainable from the company's Central Advertising Distribution Department, 1100 Main Street, Buffalo, New York.

Over 170 different picture tube types are listed on the chart, which was designed to give at a glance the most current *Sylvania* picture tube information. Added data in this new chart includes ion trap listings, focus, deflection, and base diagrams. Face, body, basings, and length-in-inches on all tubes are also included.

The company is also offering a copy of its handy, pocket-sized "TV Tube Selector Guide" which contains much the same information as the wall chart but in more portable form.

don't
just say
capacitors

Ask For Sprague By Catalog Number

Know what you're getting...
get exactly what you want.

Don't be vague... insist on

Sprague. Use complete
radio-TV service catalog

C-610. Write Sprague Products

Company, 51 Marshall Street,
North Adams, Mass.

SPRAGUE®

WORLD'S LARGEST
CAPACITOR MANUFACTURER

CRASH..

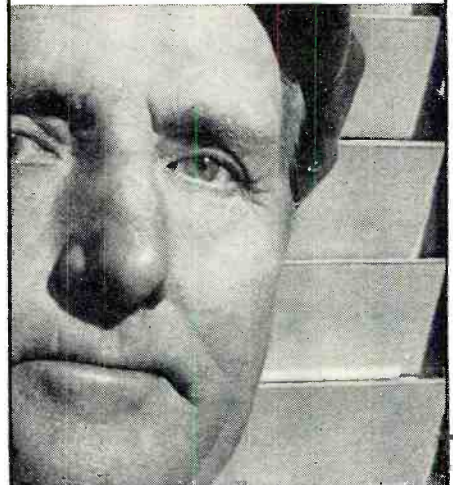

This man shatters the myth that every diamond needle protects records. Everybody's looking for his picture. Where? In the Duotone Diamond Needle Package. Why? Because he's the polisher who polishes the Duotone diamond tip 15,000 times. No chance of slight burr to feather-cut grooves. Result: More satisfaction—more sales with Duotone.

The Duotone Company Keyport, N. J.
Can. Rep., Chas. W. Pointon, Toronto;
Exp. Div., Ad Auriema, New York, N. Y.

RADIO & TELEVISION NEWS

Antenna News

NEW FAN ANTENNA

Channel Master Corp., Ellenville, N. Y., has announced the availability of a new version of its "Super Fan" antenna, featuring a completely redesigned fan head. All elements on the new antenna snap out and lock into place automatically. No hardware, tools, or tightening are necessary.

The "Super Fan's" new heavy-duty fan head is made of high-impact poly-

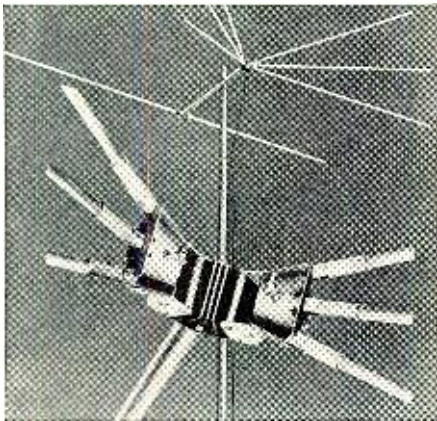

styrene, combined with heavy-gauge aluminum. The antenna itself is all aluminum, reinforced with external aluminum sleeves at the points where the elements join the brackets. The sleeves absorb vibration and prevent breakage.

The "Super Fan" is available in either seamless or butted aluminum tubing. Series 313A (seamless) consists of the single bay for \$10.42, 2-bay for \$22.22, and the 4-bay for \$48.19. The series 713A (butted) is marketed in a single bay for \$8.19 and a 2-bay for \$17.08.

COMMUNICATION TOWER

Rohn Manufacturing Co., 116 Limestone, Bellevue, Peoria, Ill., now has available a heavy-duty radio communication and microwave tower, the No. 40, that is self-supporting to 66 feet, or up to 200 or 300 feet when guyed. The tower is furnished in a hot-dipped galvanized finish and features 18-inch sides (equilateral) with steel cross bracing. It is electrically welded throughout.

Further information, catalogue sheet, and specifications can be obtained from the company.

ANTI-INTERFERENCE ANTENNA

Holloway Electronics Corp. of Fort Lauderdale, Fla., announces the introduction of its new "Expo-I.R.I.S." antennas designed to minimize interference problems. The I.R.I.S., or "infinite rejection interference system," uses two antennas, one above the other, and according to the manufacturer, by

Bob Henry,
W0ARA
Butler, Mo.



100% SATISFACTION
or Your Money Back at end of 10 day Trial

Ted Henry,
W6UOU
Los Angeles



NOW . . . HENRY DARES TO GIVE YOU THE ABOVE GUARANTEE . . . Try any receiver for 10 days. If you are not perfectly satisfied, return it and all you pay are shipping costs.

hallicrafters

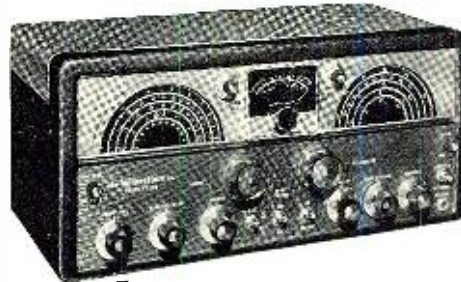

**NEW
SX100**

For top performance with extra pull power and ability to tune in stations.

\$29.50 Down

20 monthly payments of \$14.65

\$295.00 Cash Price

A few items in stock for immediate shipment are:

Model	Cash Down	20 Monthly Payments	CASH PRICE
S38D	5.00	2.47	\$ 49.95
S53A	9.00	4.45	89.95
S85	12.00	5.94	119.95
SX99	15.00	7.42	149.95
SX96	25.00	12.37	249.95
SX62A	35.00	17.32	349.95
R465 speaker			17.95
HT30	49.50	24.50	495.00
HT31	39.50	19.55	395.00
S94-S95	6.00	2.97	59.95

Write, wire, phone or visit either store today.

Butler 1, Missouri
Phone 395

Henry Radio Stores

GRanite 7-6701

11240 West Olympic Blvd. Los Angeles 64

"WORLD'S LARGEST DISTRIBUTORS OF SHORT WAVE RECEIVERS"

LET'S GET ACQUAINTED!

POSTPAID "BUCK" STRETCHERS

(East of Miss. River add 25%)
PE-101C Dynamotor Brushes, 4 Sets (40) . . . \$1.00
Volume Controls (Clarostat) 1" dia., 1/2" thick, standard shafts 1/2" long, Sizes 2-2 meg., .5 meg., 10K, 2 Sets (6 pots) . . . 1.00
Tube Sockets—Loktal and Octal 10 ea. (20) . . . 1.00
717A tubes, new cartoned6 for 1.00
3AP1 C. R. tubes, new cartonedea. 1.00

CATALOG ON REQUEST
CLEARFIELD SURPLUS SALES

W7DTB 310 North Main, Clearfield, Utah W7NAY

WANT A BETTER JOB? BECOME AN

ELECTRONIC ENGINEER

ONLY 32 MONTHS TO EARN A BACHELOR OF SCIENCE DEGREE IN ELECTRONIC ENGINEERING
Class enrollment limited to allow for individual instructions. Chartered by state of California. Nonprofit-educational—established 26 years.

APPROVED FOR VETS—ENROLL NOW!

SEND FOR FREE CATALOG

PACIFIC STATES UNIVERSITY

1516 S. Western Ave., Dept. O, LOS ANGELES, CALIF.

EASY TO LEARN CODE

It is easy to learn or increase speed with an Instructograph Code Teacher. Affords the quickest and most practical method yet developed. For beginners or advanced students. Available tapes from beginner's alphabet to typical messages on all subjects. Speed range 5 to 40 WPM. Always ready—no QRM.



ENDORSED BY THOUSANDS!

The Instructograph Code Teacher literally takes the place of an operator-instructor and enables anyone to learn and master code without further assistance. Thousands of successful operators have "acquired the code" with the Instructograph System. Write today for convenient rental and purchase plans.

INSTRUCTOGRAPH COMPANY

4711 SHERIDAN ROAD, CHICAGO 40, ILLINOIS

IN DETROIT IT'S AARON SCR-274 & ARC/5 Equip.

RECEIVERS COMPLETE WITH TUBES

1.5-9 MC-ARC/5-BRAND NEW	\$14.95
190-550 KC-ARC/5-BRAND NEW	14.95
520-1500 KC-ARC/5-BRAND NEW	19.95
3.6 MC-BC454-EXCELLENT	4.95
6-9.1 MC-BC455-EXCELLENT	4.95
Spined Tuning Knob. For Above Revr.	.89

TRANSMITTERS COMPLETE WITH TUBES

1.3-2.1 MC-ARC/5-BRAND NEW	\$19.95
2.1-3 MC-ARC/5-BRAND NEW	5.95
3-4 MC-ARC/5-EXCELLENT	6.95
4.3 MC-BC457-EXCELLENT	4.95
4.3-7 MC-BC458-BRAND NEW	4.95
7.9-1 MC-ARC/5-BRAND NEW	5.95

FIRST TIME ON SURPLUS MARKET
ARC/5 (160 Meter Mobile) Transmitter
1.3-2.1 MC-BRAND NEW \$19.95
Companion for 520-1500 KC Broadcast Receiver

701-A TETRODE. SIMILAR TO 4-125 A
4-250 A
Diagram and Info. for Amateur Use with Order
A dandy K.W. SSB final—8 V. @ 7.5 amps. plate:
3000 V. @ 200 MA. screen 280 V. @ 50 MA. Just
10 W. to drive pair 1 K.W. A.M. phone. Max. input
600 W. per tube. class C. ampl. \$2.95 ea. 2 for \$5.00.

HIGH FREQUENCY BROAD BAND IF STRIP
Can be converted to TV
video amplifier or various
other VIF applications.
With mixer panel, relay,
etc., and 10 tubes,
SAB, 1-6SN7, 1-6SL7,
5-717A. Tubes \$5.95
alone worth more

VARIABLE CONDENSERS
Ceramic Split Stator. Tunes 70-160 Mc. Ideal 2
meter oscillator section, or antenna matching
section in place of Balun as described in Hints &
Kinks, volume 5, page 75, with 953 tube. \$1.25
200 MMFD Double Bearing. 280 V. @ 50 MA. Just
15 MMFD Split Stator with Coil. Freq. approx. 2
meter. Can be used with P.P. input circuits. .59c
Neutralizing Conds. Adjustable range.
0-25 MMFD, 1 1/4" dia. plates. 69c ea.; 2 for \$1.25
75 MMFD APC type with long shaft.59c
3-13 MMFD APC type with long shaft.39c
13-325 MMFD 22 Plates Long Shaft. . . . \$1.25
3.7 MMFD Dual, with coil, 2 meter long
shaft.59c
3.7-20 MMFD Long Shaft.49c
2.5-7.5 MMFD Long Shaft.39c

THERMOSTATS
General purpose, adjustable type.
Ideal for fire alarm systems, heat-
ing, detecting, and warning de-
vices.
3 for \$1.20 10 for \$3.50
Special Price for Quantity Buyer
Upon Request

DETROIT RESIDENTS—CALL WA. 19128 FOR
DETAILS VIA PHONE ANSWERING SERVICE.

DYNAMIC MUTUAL CONDUCTANCE
1-177 tube testers. Guaranteed—in the best of con-
dition—like new. Portable. Made by Hickok or to their
specification. With chart and diagram. Sh.
Wt. 19 lbs. \$24.95

ARC/5 TRANSMITTER
3-4 MC. (80 Meters) Same as BC696
with tube and xtal. Ex. cond. Like New. . . . \$6.95

MISCELLANEOUS
Attenuator, 500-500 ω , 1.5 watt, 60 DB range,
32 steps, adjustable. \$1.95
Venier dial. Nat'l. I-1 ratio. \$1.25
40 watt. modulation transformer. 2-1 ratio,
matches 6L6's to 807's, etc. with driver and mike
mmer. \$3.95
Fl. conds., 8-8 MFD @ 600 VDC 4 prong. Plug
in type. \$1.95
PYR. cap., 1-1 MUF @ 3000 VDC. 97c
ANTENNA RELAY UNIT, RE-2/ARC-5, SAME AS
BC-442. SWITCHING RELAY, 0-10 RF METER
AND 50 MMF VACUUM CONDENSER. . . . \$3.75
NEW.
50 MMF VACUUM CONDENSER. \$1.50
RELAY (RBM #23023) 700 ω \$21.95
110 VDC DPDT. \$7c

NOTE—Terms: 25% Deposit, Bal. C.O.D.
Add 50c for orders under \$3.00

AARON ELECTRONICS
Dept. S. 3830 Chene St., Detroit 7, Michigan

6 METER CONVERTER
Push-pull 676 R.F.
amplifier into 676
oscillator-mixer.
Balanced line input.
Coaxial output. Slug-
tuned adjustments.
Output freq. 21-25
MC. Small size!
Sx34x3 1/2". Very
stable oscillator. All wired, tested, aligned WITH
TUBES & AC POWER SUPPLY. Satisfac-
tion guaranteed! \$27.95

2 METER CONVERTER: Similar to 6 Meter Con-
verter above except for substitution of air-wound
coils in place of slug-tuned coils. Completely wired,
tested, aligned WITH TUBES.
MODEL 1A: Without AC power supply. . . \$16.95
MODEL 2A: With AC power supply. . . \$21.95

See Your Local Jobber Or Write
MARSHALL MANUFACTURING CO.
Associated with K & L Radio Parts Co.
1406 VENICE BLVD. LOS ANGELES 6, CALIF.
Phone: Richmond 9-8700

merely rotating one of the antennas in-
terfering signals can be cancelled. The
rotated antenna introduces an oppos-
ing interference signal of equal ampli-
tude but opposite phase to the first in-

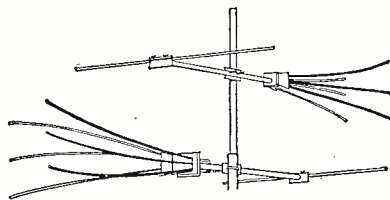

terference signal. Common forms of
interference such as "venetian blinds,"
splatter from strong local signals, and
ghosts are said to be completely elim-
inated by this antenna.

Price lists and other specifications
are available from the company.

TWO-SET COUPLER
Blonder-Tongue Laboratories, Inc.,
526-536 North Ave., Westfield, N. J., is
now delivering an impedance-matched
coupler to handle two TV or FM sets
from one antenna. The unit may also
be used to mix two antennas or ampli-
fiers into one line. The coupler is said
to be flat from 0 to 900 mc. Resistive
isolation averages better than 12 db be-
tween TV sets.

The gray metal and ebony Bakelite
case measures only 3 1/2" x 1 1/4" x 1",



and may be mounted with two wood
screws.

The model TV-42 coupler sells for
\$2.95.

BASE STATION ANTENNAS
Mark Products Co., 6412 W. Lincoln
Ave., Morton Grove, Ill., has three new
communication antennas for the 152-
174, 450-470, and 890-960 mc. bands.
All three are vertically polarized, high
gain, and omnidirectional.

The model C-7900 covers the 890 to
960 mc. range. It is a six wavelength
co-phased aperture with a power
gain of 7 db over a dipole. The eleva-
tion pattern beamwidth is 9 degrees
between 3 db points. The over-all
length of the antenna, including sup-
port pipe, is approximately 10 feet. Its
net weight is 15 pounds.

The model C-3150 antenna is for cen-
tral stations in the 152-174 mc. region.
The gain over a half-wave dipole is 4.3
db and the vertical half-power beam-
width is 26 degrees. The over-all length
is about 15 feet; weight is 20 pounds.

The model C-7455 covers the 450-460

**NEW BE QUALITY WISE...
BUY QUAL-KITS!**

Advanced 7 tube circuit
provides full sensitivity
and selectivity giving this
AM-FM tuner exceptional
hi reception. Armstrong
FM circuit with limiter,
Foster-Seeley Discrimina-
tor. 20-20,000 cps re-
sponse. Full AFC control—
no drift.

\$28.95

Cover and legs optional at extra cost.

Complete 6 tube-10 watt
amplifier. Push-pull beam
power output, built-in pre-
amp. 5 position selector
switch, 3 position record
equalization, LP, RIAA,
Eur. Response 1/2 db. 20-
20,000 cps. Output 10
watts at less than 2% IM.
Low noise level and har-
monic distortion.

\$28.50

Write today for more detailed information and
a list of dealers in your locality carrying these
remarkable units.

Quality-Electronics
319 Church Street New York 13, N. Y.

Recording Tapes—New Low Prices!
ALL BRANDS, 1200 ft. plastic, now list, 3.50, our
net 2.28. NEW.
ALL BRANDS, 1800 ft. 1 mil MYLAR long playing
tapes now list 5.50, our net 3.29. NEW.
All H.O. tapes now list 5.50, our net 3.30. NEW.
New 1/2 mil tape list 12.50, our net 7.45. NEW.
(Above are all name brands and are not "super bar-
gains" having no manufacturer's name.)
COMPLETE PRICE SHEET AVAILABLE.

USED RECORDING TAPE (PLASTIC BASE)
ATTENTION Indus-
trial users: We have
the New "Mylar"
tapes from 1/2 mil
to 3 mil thickness
by Scotch, Encore,
Reeves Audio and
Irish. We will buy
your present tapes
which is not more than 1 spicce per reel.

★ ★ ★ ★ ★
USED "MYLAR" TAPE (1 Mil)
300 ft. (3" reel)53
900 ft. (5" reel)1.34
1800 ft. (7" reel)2.69

New empty plastic reels in
boxes. 3" 10c; 4" 22c; 5"
24c; 7" 27c ea. 10 1/2" fiber-
glass Reel \$1.49. EMPTY
BOXES: 3" 3c; 4" 5c, 7"
5c ea.; 10 1/2", 25c ea.

"Tape Recording" magazine, 35c
(back issues available). Audio
Devices 1956 TAPE RECORD-
ING DIRECTORY free.
Please Include Sufficient Postage

COMMISSIONED ELECTRONICS, INC.
2503 Champlain St. N.W. Washington 9, D. C.

Say you saw it in
RADIO & TELEVISION NEWS

Another MARCUS radio book!
**LEARN RADIO BY BUILDING
YOUR OWN RECEIVERS**
Written in simple, easy-to-understand
language by the famous author of ELEMENTS
OF RADIO. (Over 1,000,000 copies sold!)

RADIO PROJECTS
by ABRAHAM MARCUS

Ten easy-to-follow projects from the sim-
ple crystal set to the modern superhetero-
dyme receiver. Over 80 drawings and pho-
tographs.

Table of Contents

- How to solder
- Crystal detector receiver
- Diode detector receiver
- Regenerative receiver
- Two power supplies
- Audio-frequency amplifier
- Tuned-radio-frequency tuner
- AC-DC superheterodyne receiver
- Code oscillator
- Color code for mica capacitors
- Color code for fixed resistors
- International Morse code

Published by Prentice-Hall. Get your copy today!

and 460-470 mc. ranges. Its vertical half-power beamwidth is 10 degrees; gain over a half-wave dipole is 7.2 db. The over-all length is 15 feet, weight is 20 pounds.

STAND-OFF INSULATORS

Channel Master Corp., Ellenville, N. Y., is now manufacturing a complete line of new-type antenna transmission line stand-off insulators featuring a unique double-duty thread design which functions both as a wood screw and a machine screw.

These "Standout" insulators when used in wood, have a needle-sharp point that provides quicker starting and minimizes the chances of splitting the wood. Used with buckles on TV masts, the "Standouts" pointed screw tip digs into the strap and mast, making a posi-

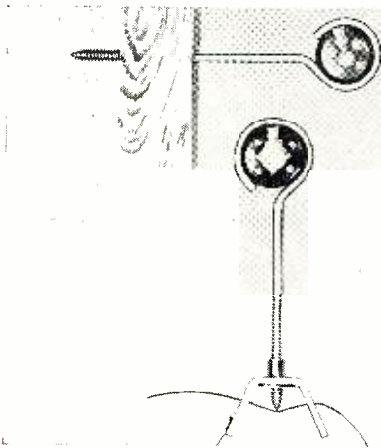

tive contact. The "Standout" buckle comes with a choice of either galvanized or stainless-steel strap.

"Standouts" are made of special high-temper steel alloy and are heavy-duty zinc coated. All double insulators are plated after welding.

ORLANDO HAMFEST

THE Orlando Amateur Radio Club will hold its annual hamfest on April 8, at Rock Springs, Florida. The affair will start at 10 a.m., with a barbecue dinner at 1 p.m. Advanced registrations are \$2.00 for adults, \$1.00 for children, 25% higher at the gate.

Contact Bob Kitchen, Jr., K4BAK, 1008 1/2 Lucerne Terrace, Orlando, Florida for full details.

AID FOR SERVICE DEALERS

A NEW 20-page booklet, entitled "A Guide to Good Business," has just been published by the Electronic Product Sales Dept. of Sylvania Electric Products Inc.

Included in the booklet are chapters on stock and inventory control, use of counter displays, insurance, public relations, correct accounting procedures, obtaining good legal advice, selling service, analyzing earning power, etc. For the novice there is such information as how to survey the market in a city or town, how to choose a good location, ideas and suggestions for window displays, workbench layouts, etc.

Write Sylvania's Central Advertising Distribution Dept., 1100 Main St., Buffalo, N. Y. for a free copy.

March, 1956



Best Buy...



Here's Why

Leo. E. Meyerson
W0GFQ

"The World's Largest Distributor of Amateur Radio Equipment"

WORLD'S BEST TRADE-INS!

Just Try Us and Find Out

MAKE ONLY 10% DOWN PAYMENT

Use Your Gear While Paying

RECONDITIONED BARGAINS, PLUS

Over 800 Top Value Items

PERSONALIZED SERVICE TO YOU

We're Easy to Do Business With

GET THE hallicrafter habit ... at WRL!

Hallicrafter's S-38D



Only \$500 per mo.

CASH PRICE: \$49.95

Hallicrafter's SX-100

Only \$1608 per mo.

CASH PRICE: \$295.00

Hallicrafter's SX-96

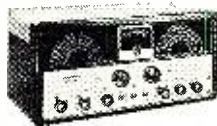

Only \$1362 per mo.

CASH PRICE: \$249.95

Hallicrafter's HT-30

Only \$2698 per mo.

CASH PRICE: \$495.00

Hallicrafter's HT-31

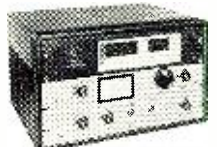

Only \$2153 per mo.

CASH PRICE: \$395.00

Hallicrafter's SX-99

Only \$1192 per mo.

CASH PRICE: \$149.95

Ask About the Complete World Radio Line!

★ Globe King 500A ★ Globe Scout 65A ★ VFO ★ 6 Meter Converter ★ Economy Code Oscillator ★ Plumber's Delight Beams ★ Antenna Kit ★ Antenna Tuner Kit ★ SWR Bridge

PLEASE RUSH: FREE CATALOG MY PRESENT:

QUOTE YOUR TOP TRADE OFFER ON FOR YOUR:

(WRL Eqpt. Desired)

I Would Like Further Information on the Following Items:

1. _____ 2. _____
3. _____ 4. _____

Name: _____

Address: _____

City & State: _____

R-3

WORLD'S MOST PERSONALIZED RADIO SUPPLY HOUSE

World Radio

LABORATORIES



3415 W. BROADWAY, CO. BLUFFS, IA., Phone 2-0277



NO INACCESSIBLE AREAS

using the Howard* Wire Cutter

The obstruction cutter for Electronic Servicemen and Hams — the Howard Wire Cutter makes inaccessibility a problem of the past. The slender, extended cutting points project into remote regions of the chassis ... in back of and around tube sockets or condensers ... cutting wires by thumb lever operation with true shearing action, closer to terminals. Also cuts finely stranded wire as well as 18 ga. ... radial shearing action eliminates dulling edges permanently. The Howard Wire Cutter will eliminate your inaccessibility problem; order yours today.

Only \$2.95 ppd.

Send check or M.O. to:
HOWARD TOOLS, P. O. Box 6205
Bridgeport 6, Connecticut

money back guarantee

HERSHEL SPECIALS
All New MYSTERY PACKAGE
 of ELECTRONIC PARTS



Worth \$40.00
 Our Price **\$395**
 Ship. Wt. 20 lbs.

IT'S the surprise of your life! 20 pounds of BRAND NEW usable Govt. surplus. The ideal gift for hams, etc.

BRAND NEW Electronic PHOTO FLASH



100 Watt Sec. Ship. Wt. 60 lbs.

\$2995

Operates on any 12 or 24 VDC source. Complete with ignition coil, trigger, housing and strobe light. Assembly includes 20 ft. cord, with SYLVANIA A-1073 200 Watt Bulb (Similar to Sylv. 4330) Extra parts kit has Extra 1073 bulb, fuses, vibrator. Instruction Manual.

ARC-5 COMMAND TRANSMITTER



\$695

7 to 9.1 MC Brand New in Carbons. with tubes.

HOTTEST BUY IN THE COUNTRY

OIL CONDENSER



\$165

2 MFD. 300 VDC. Pyranol Oil Condenser. 1 Mfd. 3000 VDC. NEW removed from equip. Size 4 3/4" x 4 1/4" x 2 1/2".

PHOTO ELECTRIC CELL



95¢

CE Vacuum Cell used in AMPRO Sound Projector. Also useful for opening garage doors and Alarm Systems.

GE Pyranol Oil CONDENSER



12 MFD. 330 VAC. 60 Cps. Removed from equip. NEW **95c**

Modulation & Driver Transformer



BRAND NEW

BOTH UNITS ONLY

Modulation Trans. 915 Class AB2 56 Watt output. Driver 6SN7 to Modulator. **\$4.95**

RCA OUTPUT TRANSFORMER



P.P. 6L6's 25 WATTS. PRI. 1500 ohms. output SEC. = 1 500 ohms 600 ohms. Eiectone 15 to 15,000 cy. flat.

\$195

SWING CHOKE



2H-7H 550 MA THORNDARSON **\$595**

HI GAIN DYNAMIC MIKE KIT



Uses UTC transformer & Western Electric Mike. Ideal for Hams, PA, CAP, Recording Mobile Equip.—50 DB 80 to 7500 CPS. Diagram Furnished **\$1.95**

KIT 1. HARDWARE



Over 1,000 pcs. Assorted. For Radio & TV **99c**

KIT 7. TOGGLE AND SLIDE SWITCHES



25 Assorted D.P.S.T.—D.P.D.T. S.P.S.T., etc. **\$325**

KIT 2. CERAMICONS

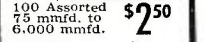

100 Assorted 75 mmfd. to 6,000 mmfd. **\$250**

KIT 8. PAPER AND CAN CONDENSERS



25 Assorted Range from 4Mfd—150V to 80Mfd—450V. **\$275**

KIT 4. Rotary Switches

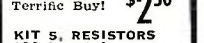

25 Assorted Terrific Buy! **\$250**

KIT 9. KNOBS



100 Assorted Push-On and Set Screw types **\$175**

KIT 5. RESISTORS

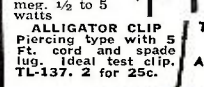

100 Assorted 1 ohm to 15 meg. 1/2 to 5 watts

\$175

ALLIGATOR CLIP

Piercing type with 5 Ft. cord and spade lug. Ideal test clip. TL-137. 2 for 25c.

TERMS: Cash with order or 25% DOWN—BALANCE C.O.D.

ALL PRICES NET F.O.B. DETROIT

MINIMUM ORDER \$2.00

HERSHEL RADIO CO.

5249 GRAND RIVER
 Detroit 8, Michigan
 Phone TYL 8-9400

RADIO-TV Service Industry News

AS REPORTED BY THE TELEVISION TECHNICIANS LECTURE BUREAU

MORE and more service dealers are joining and forming local service associations. The news this month is devoted to some of the activities among such associations.

About six months ago, the Mahoning Valley Television Service Dealers Association was formed in Youngstown, Ohio. Its membership consists of the majority of the television dealers in the city of Youngstown and in the surrounding communities.

A five-point program has been launched by the association to establish a solid base for the activity in that area. Among the objectives of the association are to determine and recommend a fair price for servicing, and to educate the public about what they should expect from their radio and TV receivers.

The officers of the Mahoning Valley Association are: W. S. Buzard, president; R. A. Komara, vice-president; John Hanlon, secretary; and R. E. Hill, treasurer.

Television dealers in Durham, North Carolina, have been discussing the formation of an association in that area. The unanimous opinion is that, to be successful, an association must be representative of dealers, service shop operators, and technicians. This can only be accomplished if men engaged in each of these three phases of the business work together in the formation of a charter, by-laws, and program for an association.

Those located in the Durham area who are interested in the formation of an effective association should contact Walter P. Cobb, *Cobb's Television Service*, Third Avenue, Bragtown, Durham, N. C.

About ninety miles away, in Winston-Salem, the radio-television technicians of that city and in Forsyth County formed an organization to promote better relations between the public and themselves. The goals of the organization are the recognition of approved and reliable service technicians, the "controlling" of bad business practices on the part of non-professional service operators, and the discouragement of unreasonable service charges.

R. L. Van Sickle was named chairman of the group, Frank Bailey, Jr. was elected secretary, and David

Dredge was named treasurer. Committees were appointed to recommend policies, membership requirements, and future programs.

At their recent quarterly meeting, the officers of the Texas Electronics Association voted unanimously to reject the proposal to join NATESA, which had been adopted at the Indianapolis Unity Meeting. They authorized their past president, Forrest L. Baker of San Antonio, to cooperate with other interested organizations in forming a new national association.

The fourth annual clinic and fair of this organization is to be held in the Rice Hotel in Houston on August 24, 25, and 26. Clinic chairman for the annual meeting is W. A. Galbreath, Sr. of Houston.

Officers and directors elected to serve during 1956 are: Van J. Roarck, Houston, president; Leonard R. Smith, Fort Worth, vice-president; Parker R. Ellis, Tyler, second vice-president; Lawrence Domingo, Houston, secretary; and G. Lewis Weseman, Harlingen, treasurer. Directors selected for the coming year are: Forrest L. Baker, San Antonio, past president; J. R. Williams, Corpus Christi; H. D. Tebay, Stamford; Bob Burns, Tyler; Earl Englerth, McAllen; Truett Kimzey, Fort Worth; and A. R. Niehaus, San Antonio. Will A. Shaw of Fort Worth will continue in the post of executive secretary.

Ed Chebator of the RTTG of Boston reports that they have set up a plan that permits any member to register with the organization and thus become a registered technician operating according to the standards set by the Guild and bound by its code of ethics. When a member registers, he is given a stamp with his assigned number. He uses this stamp to mark each chassis that he services. This identification serves to establish responsibility and is the consumer's insurance that the work was done by a registered technician. The members of RTTG feel that such a plan of self-licensing is preferable to any plan for city or state licensing of technicians.

The Guild has also stepped up its programs of technical meetings which are stimulating their members' interest and helping to add new members to the association.

ELECTRONICS CAREER OPPORTUNITIES

Now you can choose a state-chartered, non-profit technical institute for professional training on vocational and engineering technician levels. Intensive one & two year courses.

MAXIMUM TRAINING AT MINIMUM COST

Prepare for top-paying positions as Electronic Technician, Laboratory Technician, Engineering Assistant, Television Technician, Broadcast Technician, Engineering Technician, and others.

SEND FOR FREE ILLUSTRATED BOOKLET N-3

WESTERN ELECTRONICS INSTITUTE

APPROVED FOR VETERANS

5119 Sunset Blvd. Los Angeles 27, Calif.

The Radio Television Guild of Long Island re-elected Murray Barlowe as president for the coming year. Other officers elected are James Lyons, *J & D Electronics*, Woodhaven, vice-president; Abe Smolewitz, *Ace Television*, Laurelton, treasurer; Chris Stratigos, *Maple Radio*, Rockville Center, corresponding secretary; George Volkens, *Volkens Refrigeration Company*, Hicksville, sergeant-at-arms; and Art Cyr, recording secretary. Trustees for Nassau are Bob Henderson, Henry Warwick, Jim Holmes, Jack Buck, Ralph Raynor, Jack Wheaton, and Earl Horton. Trustees for Suffolk are John Siebold, Jim Corey, Gerry Rawlins, Fred Strickland, Sam Margolis, and George Knodl. Trustees for Queens are Al Neuweiler, Frank Alper, Henry Rogers, Timmy Barbash, and John Pristas.

In a move to form a state-wide association in Indiana, delegates from nine local Hoosier associations met in Indianapolis to discuss a pattern for an association that would be acceptable to all groups. Robert M. Sickels, president of the Indianapolis Television Technicians Association, was elected chairman of the group to serve at all meetings until a state organization is formed and functioning. Frank J. Teskey, of the Indianapolis group, was named secretary for the same period.

The delegates were favorably inclined toward adopting the charter for the Radio Television Service Engineers Association which was incorporated in Indiana by the Anderson association with the co-operation of associations in other cities in that area. A meeting date was set for delegates to re-assemble for further discussions of the plan after they had presented it to and received instructions from their individual associations.

The Television Service Association of Michigan threw its full strength in support of one of its members who was the butt of a politician's effort to make an issue out of a very nominal charge for radio service. In reporting the incident, the *"Detroit Times"* said:

"The Television Service Association of Michigan today backed up Robert T. Lewis, 47, operator of a Dearborn radio and TV store in a squabble with Dearborn's Mayor Hubbard over a \$3.00 service fee.

"The row took place late last month when Hubbard refused to pay the charge on a radio taken to the shop by his son, James, a policeman.

"A friend of Hubbard's known only as a 'Mr. Hill,' took six harmless swings at Lewis during the height of the squabble.

"After the argument, Hubbard declared he would 'look into this radio repair business' and charged Lewis with 'running a racket.' Hubbard then made the licensing of radio and TV repairmen a plank in his re-election platform.

"The TSA of Michigan, comprised of 265 member shops in the State, eight of them in Dearborn, including Lewis, issued the following statement after their meeting last night:

"Mr. Lewis has been in the radio business in Wayne County for well over a quarter of a century, providing honest and competent work to the consumer.

"We resent the statement of Mayor Hubbard that this particular dealer along with many others in Wayne County are gyps. We feel it was made without a true understanding of the problems concerning the repair of intricate equipment such as radio and television. It has resulted in the general attitude that the average radio and television technician is dishonest, whereas it can be proven with facts that only a small minority are dishonest.

"Ambiguous statements made by the Mayor of Dearborn can only be the direct result of his complete ignorance of a situation with the obvious thought in mind of gaining publicity at the expense of the reputation of one of Wayne County's oldest and most competent television and radio dealers."

"Spee" D. Servus

Actually, an unusually high percentage of service businesses and technicians are honest, competent, conscientious in their dealings with set owners, and implicitly fair in their charges. Also, it is a matter of record that the average charges for service labor are far too low and most service operators



14th EDITION

RADIO Handbook

The most extensive list of equipment descriptions ever bound between two covers!

A-C & D-C CIRCUITS
SEMI-CONDUCTORS
V-T PRINCIPLES
V-T AMPLIFIERS
OSCILLOSCOPES
R-F V-T AMPLIFIERS
SPECIAL V-T CIRCUITS
RECEIVER FUNDAMENTALS
R-F ENERGY GENERATION
AMPLITUDE MODULATION
FM TRANSMISSION
S.S.B TRANSMISSION
TRANSMITTER DESIGN
TV & BC INTERFERENCE
TRANSMITTER KEYING
WORKSHOP PRACTICES
ANTENNAS, H-F V-H-F, U-H-F & BEAMS
RADIATION, PROPAGATION
& TRANSMISSION LINES

MOBILE EQUIP & INSTALLATION
1-Tube Mobile Converter for 75 Meters
Mobile Transmitters
12-Watt All-Band Mobile Transmitter
Universal Modulator and Power Unit
832-A Transmitter for 144 Mc.
12-Watt Fixed/Mobile X-mitter for 225 Mc.
1-Kilowatt SSB Mobile Transmitter
Antennas for Mobile Work
Constr. & Installation of Mobile Equip.
Vehicular Noise Suppression

RECEIVING EQUIPMENT
"Super-Gainer" Receiver
Universal Q-5'er
Simple Preselector for 15 and 10 Meters
All-Triode Converter for 144 Mc.
De Luxe 2-Meter Superheterodyne
C-W Man's Superheterodyne

EXCITERS & LOW POWER TRANSMITTERS
40-Watt All-Band Transmitter
High Stability VFO Unit
220-Mc. Transceiver
20-Watt 2-Meter Transmitter
75-Watt 2-Meter Transmitter
120-Watt 2-Meter Exciter for Use with the Collins & Viking Transmitters
Versatile VFO-Exciter Unit

SPEECH & A.M. EQUIPMENT
Design of Speech Amplifiers & Modulators
120-Watt Modulator with Triode 807's
General Purpose Class B Modulator
Outboard Clipper-Filter
10-Watt Amplifier-Driver
De Luxe 15-Watt Amplifier-Driver
200-Watt 811-A Modulator
500-Watt 810 Modulator
500-Watt 304TL Modulator

HIGH FREQUENCY POWER AMPLIFIERS
Power Amplifier Design—Choice of Tubes
Push-Pull Triode Amplifiers
Push-Pull 811-A Triode Amplifier
Push-Pull Kilowatt Triode Amplifier
Push-Pull 250-TH Amplifier
Push-Pull 144 Mc 4X-150A Amplifier
Push-Pull 813 Amplifier
Push-Pull 4-250A Kilowatt Amplifier
Pi-Network Amplifier Using a 4-125A
Kilowatt Pi-Network Amplifier
4-1000A Pi-Network Amplifier
1-Kilowatt Triode Pi-Network Amplifier

TRANSMITTER CONSTRUCTION
350-Watt P.A. for Ranger Transmitter
The Ranger as Driver for Tetrode Amplifier
Vikina II as Exciter for 1-Kw Transmitter
300-Watt Phone/C W. Transmitter
Other Transmitter Assemblies

POWER SUPPLIES
Power Supply Design
Rectification Circuits
Standard Power Supply Circuits
Simple Transformer-type Power Supplies
Power Supply Components
Transformer Design
Special Power Supplies

TEST EQUIPMENT
Voltage, Current and Power
Measurement of Circuit Constants
Capacitance-Inductance Meter
Measurements with a Bridge
Frequency Measurements
The Grid-Dip Meter
1-Tube Sine-Wave Audio Oscillator
Antenna & Transmission Line
Measurements
Constr. of a Coaxial S-W-R Indicator
Silicon Crystal Noise Generator

\$7.50 in U.S.A. (plus sales tax)



BUY FROM YOUR FAVORITE DISTRIBUTOR

at above price or add 10% on direct mail orders to:

EDITORS and ENGINEERS, Ltd.

SUMMERLAND 2 CALIFORNIA

BOOKSTORES: ORDER FROM BAKER & TAYLOR CO., HILLSIDE, N.J.

At Last.

THE SPEAKER THAT PRODUCES

No Sound

Fiddles, trumpets, drums . . . these are musical instruments. They produce sound. And resonances are deliberately created to give the sound timbre and identity.

The loudspeaker, however, is not a musical instrument. Its specific function is to reproduce sound. It must in no way add to the sound it reproduces. It must be free from resonance, and free from distortion.

The HARTLEY 215 has no resonance . . . and produces no distortion.

Laboratory measurements have confirmed this fact, time and time again.

You've never heard it so good.

Substitute a HARTLEY 215 in any system. Instantly you will hear the difference . . . clean bass, smooth highs . . . and a sense of realism and presence that will amaze you.

only \$65



NOTE: Because the new Hartley 215 has no resonance, a non-resonant baffle should be used. The bass-reflex, and other conventional enclosures are tuned resonant systems. For best results the Hartley BOFFLE Enclosure is recommended . . . available in single, dual, and 4-speaker models. Priced from \$50.75.

THE NEW HARTLEY 215

At franchised dealers or write for details:

HARTLEY PRODUCTS CO.
521 EAST 162nd STREET
NEW YORK 51, N. Y.
LUdlow 5-4239

In Canada:

J. C. Swail Co.
18 Kilbarry Crescent, Ottawa 2, Canada

wanted career men
Train for a career instead of a job. Demand for our graduates exceeds supply. Effective placement. Modest costs. Small classes. Well-equipped labs. Beautiful campus. Approved for Vets. Enter March, June, Sept., Jan.

Bach. Sci. degree in 27 months
Complete Radio Eng. courses . . . TV, UHF, FM, Electronics. Also Mech., Civil, Elec., Chem., Aero. Eng. 36-month B.S. in Bus. Adm. (Gen. Bus., Acctg., Motor Transport Mgt.) . . . capable students faster. Prep courses. Write Jean McCarthy, Dir. Adm., for catalog and "Your Career in Engineering & Commerce."

TRI-STATE COLLEGE
1636 College Avenue, Angola, Indiana

have to work long hours to stay in business. Yet, despite this, the average set owner holds a very low opinion of independent service shops and technicians.

Surveys of set owners who were "taken" by gyps consistently brought out one salient fact. When asked why they picked the dishonest company to service their sets, every set owner said, "How can you distinguish between the legitimate, honest service shop and the gyps from their advertising?"

Early in 1955, the TTLB announced plans for a program for identifying ethically operated, legitimate service shops, supported by a national consumer advertising campaign on behalf of those shops. The identification is a striking cartoon character called "Spee" D. Servus and only the best service shops from coast-to-coast will be licensed to use it.

The "Spee" D. Servus plan is financed by manufacturers, distributors, and the service shops that are able to meet the requirements to participate in it. Manufacturers and distributors are participating in the program as sponsors of the national public relations program. Licensed service shops finance the cost of identifying themselves with the program in their local communities.

The program is managed under the direction of a ten-man Board of Directors. "Spee" D. Servus, Inc., is a non-profit corporation chartered under the laws of the State of Indiana. The Board of Directors is made up of one representative from each of the following industry categories: small service shops, large service shops, servicing dealers, technicians, distributors, manufacturers, publications, advertising, legal counsel, and accounting. This provides for all-industry representation.

Readers who are interested in having complete details on the "Spee" D. Servus plan should write to: Jim Bradford, secretary, "Spee" D. Servus, Inc., 331 K of P Building, Indianapolis 6, Indiana, and enclose a stamped, self-addressed envelope.

New Price Charts

A new series of service charge charts on television, radio, auto radio, and phono repairing have been prepared and are now available for distribution. Included is an interesting breakdown of the charges that should be made for repairing and adjusting "hi-fi" equipment. The table of average charges for television service, in the form of a wall chart, is based upon the increased costs of operating in today's market. The schedule of flat rate charges for professional service on home and auto radios is in the form of a four-page brochure.

You can obtain a copy of the wall chart of 1956 average charges for television service and the 4-page brochure covering flat rate charges for home and auto repair by sending one dollar (\$1.00) to TTLB Special Service Dept., P. O. Box 1321, Indianapolis 6, Indiana.

BUILD YOUR OWN AMATEUR TRANSMITTERS

from these easy-to-assemble kits!



VIKING "ADVENTURER" TRANSMITTER

Complete to the last detail, the Viking "Adventurer" is the ideal CW transmitter for the beginning amateur . . . the perfect standby transmitter for the experienced amateur. Effectively TVI suppressed—professional in appearance and design—easy to assemble and operate! 50 watts input—single knob bandswitching on 80, 40, 20, 15 and 11-10 meters. Packs enough power for world-wide radio contacts with just a simple antenna. Wide range pi-network output tuning—no antenna tuner needed. Kit is furnished complete with built-in power supply, tubes, cabinet, wiring instructions and antenna suggestions.

Cat. No. 240-181-1—Viking "Adventurer" Kit, less crystal and key \$54.95

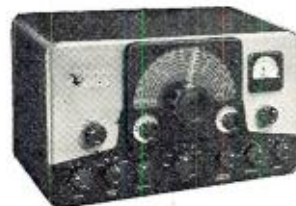

VIKING "RANGER" TRANSMITTER

Tops for operating convenience—enough power for world-wide contacts. Built-in VFO or may be crystal controlled. Bandswitching 10 through 160 meters. 75 watts CW input, 65 watts phone. Drives most kilowatt amplifiers including the Viking Kilowatt. TVI suppressed—easy to build—professional in appearance. With timed sequence (break-in) keying system. Kit or wired and tested.

Cat. No. 240-161-1—Viking "Ranger" Kit with tubes, less crystals and key \$214.50
Cat. No. 240-161-2—Wired . . . \$293.00

For detailed information see your distributor or write to:



E. F. JOHNSON COMPANY

3110 Second Ave. S. W., Waseca, Minn.



\$2.95 EACH OR 2 FOR \$5.00!

Genuine Telephone Company Upright Telephones. complete with cords. In tested and guaranteed condition with 50 ft. of wire, inter-communication instructions. Complete line of telephones and parts, dial, magneto, intercommunication, etc. Write for free list. All shipments F.O.B. Simpson, Pa. 50% deposit required on all C.O.D. orders.

TELEPHONE ENGINEERING CO.
Dept. 3C6 Simpson, Pa.

CODE SENDING SPEED
CODE RECEIVING SPEED

Be a "key" man. Learn how to send and receive messages in code by telegraph and radio. Commerce needs thousands of men for jobs. Good pay, adventure, interesting work. Learn at home quickly through famous Chandler System. Qualify for Amateur or Commercial License. Write for FREE BOOK.

CHANDLER SYSTEM CO.
Dept. 2-C, Box 928, Denver 1, Colo., U.S.A.

RADIO & TELEVISION NEWS

Phonograph Evolution
(Continued from page 65)

4-minute plays. As far as we know, this was the original 2-speed phonograph. The mechanism, although rugged, was simplicity itself. The machine was provided with a governor and speed control and was wound by a key instead of a crank. The first of these models was supplied with a model "B" reproducer. The improved model "C" reproducer was mounted to play 2-minute cylinders or the model "H" reproducer could be used for 4-minute wax cylinders. The former

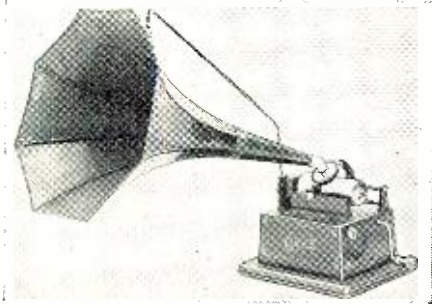

Fig. 11. This "Gem," in maroon enamel and gilt, was a deluxe model in Edison line.

were cut at 100 lines-per-inch, the latter at 200 lines-per-inch. The speed of rotation was approximately 160 rpm.

An economy model (Fig. 10) was made by Edison to retail for \$7.50. These phonographs were often given as premiums to those who would buy a quantity of cylinders. This was a single-speed phonograph using the 2-minute cylinders. A utilitarian, but practical, reproducer was permanently assembled to the overhead carriage. This model used a simple combination "on-off" control which, by twisting, would also control the speed of the governor.

The models "D" and "E" "Gem" (Fig. 11) used Edison's improved reproducer. They were finished in a special maroon enamel, and were supplied with a crane which supported his Fire-side-type horn. These models did not go on sale until about 1906 (they were the last of the series of "Gems"), and few are found with the maroon finish. They are collectors' items.

Fig. 12. Edison "Concert Phonograph," 1898, had large mandrel for four-inch records.



March, 1956

THE MUSICAL MASTERPIECE SOCIETY INVITES YOU TO ACCEPT

FREE

BEETHOVEN'S 9th SYMPHONY

(The Choral)

Plus Beethoven's 1st and 8th Symphonies

Netherlands Philharmonic Orchestra and Chorus Under the Baton of Walter Goehr

All Three Symphonies Complete

To The Last Note! The Most Astounding Record Offer Ever Made!

To demonstrate the amazing value, the magnificent artistry of the Society's recordings take this majestic new album of BEETHOVEN'S NINTH . . . plus Beethoven's 1st and 8th symphonies—as a FREE GIFT! No obligation to buy another record ever. We simply want to introduce you to the enjoyment awaiting you in all the new releases listed below. Great masterpieces performed by world renowned artists and orchestras . . . reproduced on high-fidelity discs encompassing the entire range of human hearing.



Save Over 40% off usual cost
When you send for your FREE GIFT Recordings, you also become eligible to audition FREE any or all of these 30 additional discs at the rate of two a month. Pay only \$1.65, plus shipping, for each you keep. Pay nothing for those you don't want after 5 day trial. FREE GIFT is yours in any case. Mail coupon now!

THE MUSICAL MASTERPIECE SOCIETY, Dept. 47-3
43 W. 61st St., New York 23, N. Y.

Rush my FREE GIFT album of Beethoven's 9th, 1st and 8th symphonies. Also deliver for a 5 day free home trial the long-playing selections I have NOT crossed off at the right, about one a month. I will be billed only for those I keep — at only \$1.65 plus shipping, per long-playing disc. I may return any recording, and pay nothing. I may cancel my Trial Membership at any time. Free Gift is mine to keep in any case.

Name

Address

City..... Zone.. State.....

Just Imagine the Fabulous Record Collection You Can Build From This List!

(Cross out only those you do not want to audition Free)

- 1. DVORAK: Symph. No. 5
- 2. TCHAIKOVSKY: Violin Con.
- 3. MOZART: Piano Con. No. 24
- 4. BACH: Magnificat in D
- 5. BEETHOVEN: "Emperor" Concerto
- 6. BIZET: Symph. in C
- 7. VIVALDI: Four Seasons
- 8. SCHUMANN: Piano Concerto
- 9. HAYDN: Trumpet Concerto, and Flute Concerto
- 10. SCHUBERT: "Trout" Quintet
- 11. MOZART: "Jupiter" and 17th Symph.
- 12. CHOPIN: Piano Con. No. 1
- 13. BACH: Violin Con. No. 2
- 14. RIMSKY-KORSAKOFF: Capriccio Espagnol; Mussorgsky: Intro. to "Khorovantchina"
- 15. DEBUSSY: Quartet in G; and Sonata for Cello and Piano
- 16. BEETHOVEN: "Appassionata" and "Moonlight" Sonatas
- 17. BRUCH: Violin Concerto; PAGANINI: La Campanella
- 18. MOZART: Clarinet Quint.
- 19. SAINT-SAENS: Violin Concerto No. 3
- 20. MOZART: Symph. Nos. 40 & 34
- 21. GOLDMARK: Rustic Symph.
- 22. BEETHOVEN: Symph. No. 7
- 23. CHOPIN: Sonata No. 2
- 24. HAYDN: "Surprise" and "Military" Symphs.
- 25. FRANCK: Symph. in D
- 26. STRAVINSKY: Firebird, and Piano Con.
- 27. SCHUBERT: Symph. No. 3
- 28. PROKOFIEFF: Violin Con. No. 1 and Piano Con. No. 1
- 29. MENDELSSOHN: "Scotch" Symph.
- 30. DVORAK: "American" Quar.

NOW! MODERNIZE OLDER RCA TV SETS WITH— METAL-TO-GLASS CONVERSION KITS

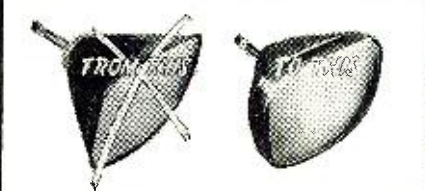

METAL PICTURE TUBE - GLASS PICTURE TUBE

NOW install new Aluminized Picture Tubes in old style Metal-tube 21" RCA sets . . .

C-1 Kit for RCA's to mid-1953
C-2 Kit for late 1953 & 1954 RCA's

QUICK - EASY LOW COST.

Nothing else to buy except the 21" glass tube. The average technician can convert any RCA 21" set in less than ONE HOUR.

\$5.95
LIST PRICE

At Leading Parts Distributors Everywhere

FREE! HIGH QUALITY, ADJUSTABLE

Power Grip Wrench as introductory offer with each kit. Write your name and address on back of the box flap from either a C-1 or C-2 kit and mail it to the factory. Your wrench will be sent free of charge.



OFFER EXPIRES JUNE 30, 1956
COLMAN TOOL & MACHINE CO.
BOX 6001 AMARILLO, TEXAS

MISSILES... who designs them?

Nike . . . Matador . . . Navajo!
The Age of Missiles is here. Giant aviation companies such as Douglas, Convair, Lockheed and Northrop—industrial giants such as G.E., Westinghouse and Bendix—all these and many more are establishing separate Missile Divisions, staffed with hundreds of engineers and needing hundreds more.

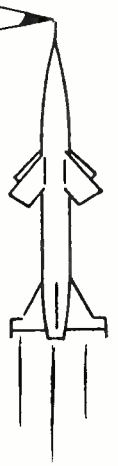

NORTHROP INSTITUTE'S two year engineering training program recognizes the tremendous part Electronics is playing in creative Aeronautics today. That is part of the reason why there is a waiting list for Northrop graduates.

COURSES APPROVED FOR VETERANS

Take the first step toward the career of your choice right now.

MAIL COUPON FOR FREE CATALOG

Please send me immediately the Northrop catalog, employment data, and schedule of class starting dates. I am interested in:

- Aeronautical Engineering Technology
- Aircraft Maintenance Engineering Technology
- Master Aircraft and Engine Mechanic
- Jet Engine Overhaul and Maintenance

Name.....Age.....
Address.....
City..... Zone..... State.....
Veterans: Check here for Special Veteran Training Information.

Save time — Step up efficiency in ELECTRONICS DESIGN



Here's a wealth of technical help for efficiently handling electronics design problems—help that gives you answers already worked out by the country's top electronics men!—help that can save you hours of research and experimentation!

You'll find electronics mathematics and theory in concise form—design practices for hundreds of pieces of electronics equipment—and even the results of advanced electronic experiments. Radio, television, facsimile, sound, and scores of other phases of electronics are covered—and it's all condensed, classified, and indexed for quick, easy use.

ELECTRONICS DESIGN LIBRARY

Edited by Markus and Zeluff, *Electronics Magazine*
4 vols., 2151 pp., 9 x 12, 3534 illustrations

Contains 1083 articles culled from recent issues of *Electronics*—the cream of information essential to design of electronics equipment. The 4 big volumes are: *Electronics for Engineers, Handbook of Industrial Electronic Circuits, Electronics Manual for Radio Engineers, and Electronics for Communication Engineers.*

Special price saves you \$6.00
Regular catalogue price of books totals \$39.00; under this offer, price is only \$33.00, on easy terms.

EASY TERMS!

10 DAYS' FREE EXAMINATION

McGraw-Hill Book Co., Inc., Dept. RTN-3
330 West 42nd St., New York 36, N. Y.

Send me for 10 days' examination the ELECTRONICS DESIGN LIBRARY. In 10 days I will remit \$8.00, plus few cents delivery, then \$5.00 a month until \$33.00 is paid. If not satisfied, I will return books postpaid. (We pay delivery if you remit with this coupon, same return privilege.)

(PRINT)

Name

Address

City Zone State

Company

Position

For price and terms outside U.S. write McGraw-Hill Int'l., N.Y.C. RTN-3

PRINTED CIRCUIT KITS

PRECISE PHOTOGRAPHIC PROCESS

Make professional quality circuits of your own design without photographic equipment or experience

KEPRO Kits feature presensitized copper-clad laminates requiring only exposure development prior to etching. This simple inexpensive processing gives experimenters, hams and engineers alike a chance to investigate all phases of etched circuits—from experimental designs to production prototypes.

P-101 PROFESSIONAL KIT—Features 36 sq. inches (2 sheets) presensitized copper-clad phenolic, all processing chemicals, developing & etching trays, priming frame, mechanical negative materials. Ready for use. **540**

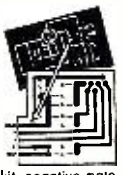

L-505 PRINTED CIRCUIT LAB—A complete laboratory for the experimenter or industrial. P.C. sockets, connectors, hardware, a large quantity of presensitized single & double copper-clad phenolic, a photo-layout kit, negative material, glass processing trays, printing frame, photo-flood lamp, safe light, all processing chemicals, and more. **3150**

S-101 STANDARD KIT—Uses a manual method of applying a liquid etchant resist. 2 sheets copper-clad phenolic, etching tray, applicator, all chemicals, etc. **345**

If not available from your jobber, order direct F.O.B.

KEIL ENGINEERING PRODUCTS

4356 Duncan Ave. St. Louis 10, Mo.

Edison became interested in his phonograph as a device which would be capable of entertaining a large group of people, either at home or in the concert hall. At the same time, he was working on means for providing longer playing time for his cylinders. As a result, he developed his Concert Phonograph (Fig. 12) which featured an oversized mandrel of approximately 4 inches in diameter and used records of special manufacture designed specifically for this machine. These were of the soft wax type and, except for their size, were identical to his Gold-Moulded Records which were the standard of their day. This model used the same motor mechanism as did his "Triumph" model. Due to the greater drag of the larger cylinder, it was necessary to use a heavy-duty motor with this model. The one we have in our own collection will play five records at one winding. An all-brass horn was supplied which was capable of producing greater volume than the short horns found on Edison's earlier models. The horn was supported by a floor stand with a special crane-like device as shown in the illustration. This model is relatively scarce at this writing.

One of a series of "Nickel-in-the-Slot" units developed by Edison (Fig. 13) is the "Excelsior" Phonograph. Edison had fourteen different coin-operated phonographs. Only a few, including the "Excelsior," were made in any great quantity. This model was first made in 1900. It used the mechanism of the Standard Phonograph to which was added the necessary tripping mechanism actuated when a nickel passed through the chute, and dropped into a spoon-like device which, in turn, disengaged a ratchet which served to lock the crank shaft. As soon as the record was started, the coin was spilled and the gearing made ready for its next cycle. This was one of the forerunners of the juke box.

An interesting postscript to the foregoing is the use of horse and wagon in merchandising Edison's Gold-Moulded Records at the turn of the century (see page 64). Here cylinders were sold by a "traveling salesman" who may be seen dispensing his wares in a neighborhood of music lovers (!).

(To be continued in May Issue)

Fig. 13. A "juke box" by Edison in 1900. This was known as his "Excelsior" model.

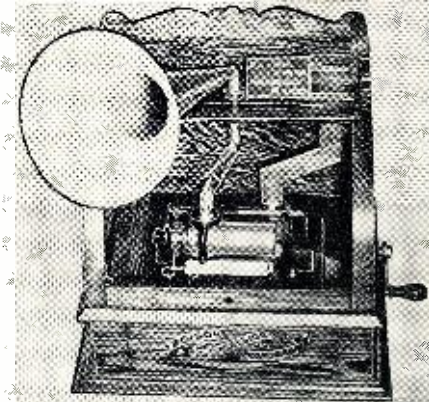

You can operate a SECOND TV or FM set from ONE ANTENNA with Photocircuits!

TWO SET COUPLER

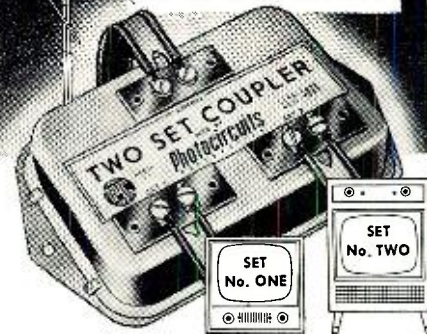

No need to buy a second antenna! Save money, time and trouble, too, by using this new TWO SET COUPLER. Photocircuits' new TWO SET COUPLER provides perfect matching of both your sets to your present antenna and gives you equal or better picture and sound on every channel or frequency.

Latest printed circuit design (for low cost and best performance!). Eliminates a cause of "ghosts." No inefficient resistors or transformers. Both your sets can operate simultaneously! Easy to install (just hook it up!).

Accept no substitute. Insist on a genuine Photocircuits TWO SET COUPLER.



See your local dealer or write...



Dept. RTV3, Sea Cliff Avenue
GLEN COVE, NEW YORK

BRAND NEW GUARANTEED SURPLUS Priced Below Manufacturer's Cost!

FINEST QUALITY IMPORTED PRECISION PLIERS 75c ea.

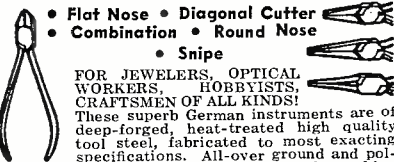

FOR JEWELERS, OPTICAL WORKERS, HOBBYISTS, CRAFTSMEN OF ALL KINDS! These superb German instruments are of deep-forged, heat-treated high quality tool steel, fabricated to most exacting specifications. All-over ground and polished to smooth hard surfaces. Smooth working joints with just the right tension. Jaws meet perfectly to safely and securely hold even the most delicate objects in the hard-to-reach corners and angles. Each plier is 4" long and a veritable gem of precision and strength.

75c each—all 5 for \$3.50 ppd.

6 SWISS PRECISION SCREWDRIVERS

Perfect for jewelers, watchmakers, hobbyists, etc. SIX DIFFERENT SIZES: No. 3, No. 4, No. 5, No. 6, No. 8, No. 10. Knurled body grip assures easy handling. Finest steel and craftsmanship. A hard-to-beat value from Switzerland. .ppd. **\$1.25**

6-Pc. METAL CUTTING FILE SET

Made from the best quality tool steel, designed for the requirements of mechanics, watch and jewelry craftsmen. Compartmented plastic kit contains the following 5 1/2" long needle files with round shanks and high test cutting qualities: round, half-round, flat, oval, knife, square. **98c** (plus 10¢ hdg & pstg)

PLASTIC ELECTRICAL TAPE

Resists abrasion, water, acids, alkali and corrosion. First quality guaranteed. 3/4" wide, 30 ft. roll—98c value—

NOW 2 for \$1.00
108 ft. roll—reg. \$2.98
NOW **\$1.69** ppd.

SPECIAL LOW PRICES TO QUANTITY USERS. Write! Send check or money order. If C.O.D. fees extra. Money Back Guarantee

SCOTT-MITCHELL HOUSE, Inc.
Dept. M-158, 611 Broadway, N. Y. 12, N. Y.

Spot Radio News
(Continued from page 18)

for a reasonable length of time, such as a year. The Washington scientists found that present-day voltmeters using thermionic or crystal diodes are generally not reliable as lab standard references; even under most careful treatment the uncertainty in their calibration is about 10 per-cent and may quite frequently be as high as 20 per-cent.

Studies have disclosed that the most stable elements suitable for calibrated-type r.f. voltmeters are thermo-elements, waveguide-below-cut-off, or capacitive-type attenuators, capacitive voltage dividers, and some well-constructed resistive attenuator pads.

One of the high-frequency AT voltmeters, which consists of a continuously adjustable waveguide-below-cut-off piston attenuator, a thermo-element, and a d.c. millivoltmeter, was designed in the Bureau labs for high voltages at the higher frequencies. The traveling piston of the attenuator houses the thermo-element and a built-in auxiliary r.f. probe. This probe can be used to calibrate the AT voltmeter in terms of a primary standard bolometer bridge; the bridge output has been found to be approximately 1 volt, which is insufficient for direct calibration of the voltmeter over an appreciable part of the frequency range in question. Because of the intentionally-introduced high-insertion loss of the attenuator, at 5 mc. for example, it was found necessary to apply more than 300 volts to the voltmeter for a sufficiently large output of the thermo-element, whereas 1 volt would be adequate at 900 mc. The probe provides means to calibrate the voltmeter with 1 volt or lower voltage levels at all frequencies. An r.f. receiver is connected to the probe output, and a standardized r.f. voltage is applied to the AT voltmeter. The receiver indication is noted at the minimum attenuator setting. The r.f. voltage is then increased to a value V_0 , at which the millivoltmeter is indicating a calibration reference output of the thermo-couple. Attenuation in the AT voltmeter is then increased to reproduce the original indication on the receiver. With both the change in attenuation and the standardized voltage known, the magnitude of V_0 applied to the AT voltmeter can be computed. Only one voltage level, V_0 , needs to be calibrated at a given frequency; all other voltages at this frequency in the range of the instrument are then accurately known.

Another design, having relatively close electrode spacing, behaved over part of its range like a continuously-adjustable capacitive attenuator and required extensive calibration; its voltage range was about 100:1. Single AT meters, utilizing both the capacitive and the waveguide-below-cut-off ranges, as well as the range of the

"G" PRESENTING THE *New*
GRIP SPINTITE
PATENTS PENDING
WRENCHES

FINEST QUALITY
STEEL SHANK
AND SLEEVE
○
BRIGHT PLATED
FINISH
○
STRONG
PLASTIC HANDLE

WITH THE EASY "FINGER-CONTROL"
GRIP AND RELEASE ACTION
FOR THOSE
HARD-TO-GET-AT PLACES —

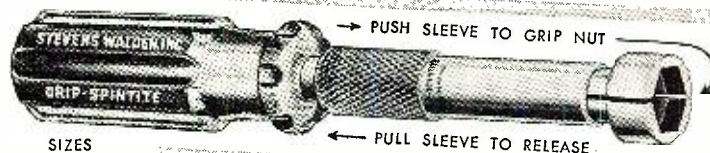

SIZES
3/16" TO 1 1/16"

BY THE MAKERS OF
THE ORIGINAL
SPINTITE
WRENCHES
OVER 150 STYLES
AND SIZES

ONE HAND OPERATION—

- GRIPS nuts or bolts of any material
- HOLDS firmly in any position
- TIGHTENS nut or bolt securely
- RELEASES at the pull of the fingers!

101-4

Write for
catalogue

STEVENS WALDEN Inc.
450 SHREWSBURY STREET — WORCESTER, MASSACHUSETTS
MAKERS OF WORLD-FAMOUS HAND TOOLS FOR OVER 50 YEARS

Electronic Field Engineers

WANTED

GRADUATES OR EQUIVALENT

(Veterans Preferred)
Veterans with military exp. as U. S. Navy Technician mates, Army technicians or Air Force A & E exp.

FOR TECHNICAL SUPERVISION DURING
INSTALLATION AND SERVICING OF
WORLD FAMOUS SPERRY EQUIPMENT
IN THE U.S. AND OVERSEAS

Experience gained while installing world famous Sperry equipment will greatly enhance the professional standing of the Engineers we seek. Must be willing to relocate. Family relocation and rental allowance

FULL EMPLOYEE BENEFITS

Please Submit Resume To
Mr. J. W. Dwyer
Engineering Employment Supervisor



SPERRY
GYROSCOPE COMPANY
Division of Sperry Rand Corp.
Great Neck, Long Island, N. Y.

NOW! INSTANT SOLDER GUN and COMPLETE "DO-IT-YOURSELF" KIT



Includes:

- ✓ 150-Watt Instant Solder Gun Model G14
- ✓ Cutting Tip for plastic tile, old putty, toys, etc.
- ✓ Smoothing Tip for furniture scratches, sealing, etc.
- ✓ Famous Kester TV-Radio Resin Core Solder
- ✓ Sandpaper for cleaning parts

"You'll like the way it HANDLES!"

COMBINES ALL THE ADVANTAGES OF THE SOLDER GUN AND THE CONVENTIONAL SOLDERING IRON. No waiting - press trigger and solder at once. Ideal tool for shop or home use. Takes only half the space of transformer guns in tool boxes.

120 Volts AC-DC 1/4" Tip (also available 1/8" Tip)

COMPARE THESE FEATURES WITH ORDINARY SOLDER GUNS!

- POWER PACKED—150 Watts
- NO HEAVY TRANSFORMER —weighs only 8 oz.
- STURDY LIFETIME TIP —no soft fragile wire
- HEAT RIGHT IN TIP —new unique element design
- LONGER, THINNER REACH —EFFECTIVE SPOTLITE

HEXACON ELECTRIC COMPANY
161 WEST CLAY AVENUE, ROSSELLE PARK, NEW JERSEY

Serving Craftsmen for a Quarter of a Century

MODEL PRECISION 612 RELIABLE TUBE TESTING AT MODERATE COST



Employs popular RETMA emission type circuit

- ★ Tests All Modern Tube Types - Fil. Voltages 1/4 to 117 volts.
- ★ Built-in 7 & 9 Pin Straighteners.

- ★ Absolute Free-Point 10 element lever selection.
- ★ Dual Short-Check Sensitivity. ★ Ballast Unit Tests.
- ★ Tests Each Section of Multi-Section Tubes.
- ★ Noise and Condenser Test pin jacks.
- ★ Hi-Speed Roll Chart ★ Micro-Line Adjustment.
- ★ 5 1/4" PACE Meter, 2% Accuracy.
- ★ Dynamic "Under-Load" Test for all popular radio A, B, and C dry batteries.

Model 612-P Deluxe: (Illustrated) Modern 2 color satin brushed aluminum panel. Rubbed natural finish, hardwood cabinet. Net Price: \$89.50
Model 612-P Standard. Net Price: \$84.50

PRECISION Test Equipment is available and on display at leading electronic parts distributors. Ask for latest complete catalog.

Precision Apparatus Co., Inc.

70-31 84th STREET • GLENDALE 27, L. I., N. Y.

Export: 458 E'way N.Y.C., U.S.A. Cables: MORHANEX
In Canada: Atlas Radio Corp. Ltd., Toronto 18, Ontario

NEW TV STATIONS ON THE AIR

(As of February 25, 1956)

The following new stations bring the lists published in previous issues up to date.

STATE, CITY	STATION	CHANNEL	FREQUENCY RANGE (IN MC.)	VIDEO WAVELENGTH (IN FT.)	VIDEO POWER (IN KW.)
Texas Odessa	KOSA-TV	7	174-180	5.61	102
Sweetwater Territories	KPAR-TV	12	204-210	4.79	26
Juneau, Alaska	KINY-TV	8	180-186	5.43	2.63

The frequency of the video carrier = 1.25 + channel lower freq. limit. Total number of TV stations now on the air in U.S.: 477 (116 of which are u. h. f.).

thermo-elements, will have, it was found, an over-all range of 1000:1 at all frequencies in question. The upper voltage would diminish with increasing frequency; for example, it would be about 900 volts at 100 mc. and about 300 volts at 500 mc.

Still another design is the capacitive single-frequency r.f. voltmeter. The essential difference between this design and those described is a fixed capacitive attenuator. Although designed for a single frequency, it may be calibrated and used over a range of frequencies.

A CONTINUOUS FURNACE FOR CURING TAPE resistors, featuring the use of a liquid heat-exchange medium to achieve highly stable temperature control, is now in operation at the National Bureau of Standards in Washington. While the equipment, in which the curing temperature can be held to plus or minus 1 degree centigrade on long-term operations, was built as a lab unit, it is, it was said, well suited for production-line applications. The furnace processes each resistor identically and makes possible the manufacture of closer-tolerance tape resistors for module wafers or printed circuit plates.

The tape resistor processed in this furnace is a self-adhesive type, consisting of a carbon formulation applied to an asbestos-paper tape base. The composition of the formulation and the variety of the carbon determine the resistance value, since the resistors are cut to the same size; .130 by .300 inch. After the resistor has been placed in a printed circuit, it must be cured to fix its resistance value. As many as four resistors, mounted on a ceramic plate, bearing a fired silver conductor pat-

tern, can be cured by placing in an oven and heating to a predetermined temperature for a prescribed period of time. Because of the different carbon formulations, each resistor may require different temperature and time-curing schedules. Since it is clearly impossible to cure the resistors in the assembled circuit, according to individual schedules, a compromise was adopted for curing all resistors. This compromise schedule, based on results obtained from experiments performed on over 6000 tape-resistor specimens, was a governing factor in the design of the continuous furnace.

In the furnace, a continuous belt carrying the resistors, moves axially through an inner pipe. Normally, the tape resistors, when mounted on printed circuit plates, are cured at 300° centigrade, and spend four hours in transit from cold entrance to cold exit. One-hundred seventy-five resistor wafers, used in the Bureau's module setup, can be accommodated by this continuous furnace each hour.

SUNSPOTS, those persistent trouble-makers which cause freak reception, are back in full force and will linger on for quite a while, generating mounting headaches for the mobile 25 to 50-mc. bands, and the low-band television channels as well.

The problem is so acute and will become so bad that the FCC has alerted all commercial mobile operators, including industrial, land transportation, public safety, domestic public, and remote pickup services. The Commission said that it had begun to receive complaints from a number of areas. In some instances, interference was reported to be so disturbing that wired circuits had to be used, while the radio

NEW TV GRANTS SINCE FREEZE LIFT

Continuing the listing of construction permits granted by FCC since lifting of freeze. Additional stations will be carried next month.

STATE	CITY	CALL	CHANNEL	FREQUENCY	POWER*
Wisconsin	Madison	---	3	60-66	100

NEW CALL LETTER ASSIGNMENTS

STATE	CITY	CALL	CHANNEL	FREQUENCY
Idaho	Twin Falls	KHTV	13	210-216
Michigan	Ironwood	WJMS-TV	12	204-210
Tennessee	Memphis	WKNO-TV	10	192-198
Texas	Corpus Christi	KBIS-TV	6	82-88
Virginia	Richmond	WRVA-TV	12	204-210

*ERP=(effective radiated power, kw.)

lines were blacked-out for some hours. The sunspot cycle, which runs an eleven-year course, is expected to reach its worst peak during the winter of '57-'58.

To escape the damaging effects of the sunspot blizzard, the FCC suggested that mobile services consider use of the higher frequencies.

AS THE GENERAL OVERHAUL study of the sixth report of '52 was being made by the Commission, the records showed that over 100 applicants for some 40 channels were waiting for a decision that would tell them whether they would be allowed to live or wither. Contestants in this unfortunate category are scattered all over the country: Tennessee, Ohio, Texas, California, Florida, Nebraska, Washington, and Illinois.

No action on this situation is expected for months. In the meantime, the grant operation had slowed down to a slow crawl; only one commercial TV authorization had been issued as we were going to press; see page 182 of this issue.

THE NEXT FEW YEARS will witness a marked swing to the use of radio in telephone communications, experts are predicting freely.

Microwave equipment, for several years, has been used for long-distance telecommunications; there has been a growing demand for such equipment for short and medium hauls, since radio has been found to be more economical and reliable than wire circuits. Such radio links are being used very successfully between Seattle, Washington, and Vancouver, British Columbia, in country that is extremely mountainous.

In many instances, it has been said, radio systems can be installed more rapidly than pole lines, and additional channels are less costly.

A resounding victory for radio . . . L. W.

PHOTO CREDITS

Page	Credit
31, 46, 47	General Electric Company
35, 36, 37	RCA Service Co., Inc.
42, 43	Sylvania Electric Products Inc.
45	Almo Radio Company
49, 51	Viking of Minneapolis
58, 59	Emerson Radio & Phonograph Corp.
64 (top, Fig. 1), 65 (Figs. 5, 7, & 8), 179, 180	Thomas Alva Edison Foundation Museum
64 (Fig. 2), 65 (Figs. 4, 9, & 10)	Richard Byron Conrad
65 (Fig. 6)	Tetrad
100	Heath Company
103	Ram Electronics Sales Co.

ADDENDUM

In the Editorial Note appearing on page 151 of our January 1956 issue in connection with the article "Choosing a Phono Pickup," we should have included ceramic cartridges along with the crystal units as comparing quite favorably, performance-wise, with the magnetic type, according to the manufacturers of such ceramic devices.

AIREX THE ELECTRONICS SUPERMARKET

TOP M RCHANDISE AT ROCK BOTTOM PRICES

SPECIAL INTRODUCTORY OFFER MATCHED HI-FI CONSOLES

Airex does it again by bringing you these 2 beautiful pieces. Solidly built to last and smartly styled in true decorator fashion. Buy both together and deduct \$5 from prices listed below.

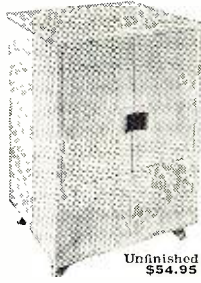

Unfinished \$54.95

AIREX EQUIPMENT CABINET—21" wide x 18" deep x 32" high. 3 1/2" stock throughout. Lift top to accommodate any record changer or player. Record changer compartment is 19 1/2" x 16" x 6". Front equipment compartment—fits forward to hold any tuner-amplifier or combination. Measures 10" wide by 10 1/2" high. Complete with blank panels for tuner & record changer-**PLAYER**. FINISHED IN MAHOGANY, LINED OAK, WALNUT, OR BLOND \$59.95

AIREX SPEAKER ENCLOSURE—21" wide x 18" deep x 32" high. 3 1/2" stock throughout. Available in corner type and square models. Base reflex type. Cut for 15" speaker with 12" adapter board. Acoustically lined with sound absorbent material. UNFINISHED \$49.95 FINISHED IN MAHOGANY, LINED OAK, WALNUT, OR BLOND \$54.95

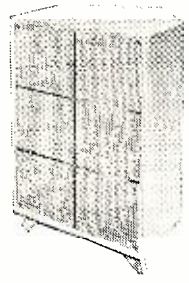

RECORD CHANGER BARGAINS



WEBSTER MDL 140: 3 speed intermix, automatic shut off, dual styli cart. 2 pole motor. Reg. \$37.50. **\$22.95**

WEBSTER MDL 140 GE: 3 speed intermix, with GE reluctance RPX 050 cart., dual sapphire styli, automatic shut off. Reg. \$40. **\$26.95**

GARRARD RC 80: 3 speed, weighted turntable, 4 pole motor, automatic shut off, with heads, line cord & plug. Reg. \$49.50. **\$42.95**

COLLARO RC 54: 3 speed intermix, automatic shut off, weighted turntable, plug-in head. Reg. \$48.75. **\$37.50**

COLLARO RC54 WITH RONETTE DUAL SAPPHIRE STYLI HI-FI CARTRIDGE. **\$39.95**

MONARCH MDL UAG: British made. 3 speed, weighted turntable, intermix automatic shut-off, 4 pole motor, with hi-fi crystal cart. & dual sapphire styli. Reg. \$49.95. **\$24.95**

MONARCH: same as above with RE-COTON-GOLDRING 500 SS reluctance cart. & dual sapphire styli. **\$29.95**

RECORD CHANGER BASES & BOARDS

for the above changers
BASES . . . \$3.89 MOUNTING BOARDS . . \$1.95
12" Alumin. Ball Bearing Phono Slides . . pr. \$1.95

TRIPLE PLAY CART TYPE GE RPX 052 A
Reluct. triple play .003 mill sapphire & .001 mill diam. Silver case. Reg. \$23.37. Ltd. Quantity . . **\$14.95**

TRIPLE PLAY CART TYPE GE RPX 050A
Reluctance. Triple Play. Dual Sapphire Needles. **\$5.49**

45 RPM SPINDLES
GARRARD \$3.49
WEBSTER \$3.89
COLLARO \$3.79
MONARCH \$2.95

STANDARD COIL TYPE PENTODE TUNER
21.25 Mc IF Replacement for almost any type of TV set. 7 1/2" or 2 7/8" shaft. Specify desired length. Knobs to match 69c **\$7.95**

AIREX Hi-Fi Speaker Enclosures

8" Shelf Mdl, unfin. 23 1/2 x 11 x 10 1/2 \$16.95
8" Shelf Mdl, mahog or blond. 23 1/2 x 11 x 10 1/2 19.95
12" Shelf Mdl, unfin. 24 x 21 x 10 1/2 20.95
12" Shelf Mdl, mahog or blond. 24 x 21 x 10 1/2 23.95
15" Floor Mdl, unfin. 20 x 20 x 15 1/2 29.95
15" Floor Mdl, Mahog or blond. 20 x 20 x 15 1/2 34.95
All cabinets completely assembled with grill cloth and acoustical material. 15" floor models come with 12" adapter board.

630-9 30 TUBE 21" TO 27" CHASSIS

• High gain cascade tuner • Fringe area control • AGC control • 90° deflection • No drift operation • Channeloc locks picture & sound together • 18 KV H.V. power supply • Phono connection & switch • 4 microvolt sensitivity
Complete with RCA 12" speaker. Less CRT tube. **\$159.95**

TUBE MOUNTING BRACKETS—\$9.95

TV PICTURE TUBES

21" \$33.95
24" 49.95
27" 69.95
Nationally known Brands. Aluminized. New. 1 Year Guar.

PLASTIC TV MASKS

1 piece lucite. Gold border. Outside mount. 21" \$ 7.95
24" 14.95
27" 17.95

TELECHRON CLOCK TIMER

Automatically turns on & off any appliance. TV set or radio. Built-in heavy duty switch. Handles up to 15 AMP 115 V. Radium hands. Built-in 1 hour sleep switch. Beautiful gold numerated, lucite face plate. Value \$12.50 **\$4.95**

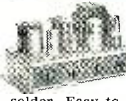

Grommes Hi-Fi Amplifier Kit

10 Watts. 18 watts peak. Resp. 20,000 cps 1 db. Preamp. 4 inputs. Hum—80 db. 2% Hurrn. Dist at 10 watts. Complete with detailed step by step instruction manual, all resistors, condensers, tubes, wire & solder. Easy to make. 2-12AX7, 2-6V6, & 5Y3. Bass & Treble boost. Limited quantity **\$21.95**

WESTERN ELECTRIC POWER AMPLIFIER

Complete with Ruggedized 6S7, 6SC7, 6L6—condensers, chokes, resistors. Many uses. Original cartons. From radar equip. Gov't cost \$95. Tubes worth \$7.75. Complete **\$349**
Send for FREE catalog on Hi-Fi amplifiers, tuners, cabinets & enclosures, Special Kit Catalog. Send post card to be put on mailing list.

All merchandise is brand new, factory fresh & guaranteed. Mail & phone orders filled on receipt of certified check or MO of 20% of items as a deposit. Balance C.O.D., F.O.B. factory N. Y. Prices & specifications subject to change without notice.

AIREX RADIO CORP. 171 Washington St., N.Y. 7, N.Y. (Near Cortlandt) CO 7-5218

Wanted



Want Edison Tin-foil, Treadle, and Water-Power models. (Do NOT want any Edisons made after 1900)

Want Victor Talking Machine Types A, C, D, and E, Monarch Special, Improved Monarch, and Victor O.

Want Double Bell Wonder, Coronet, and Bettini Micro-Reproducer.

Need Early American or Columbia Graphophone illustrated catalogues or literature. Also Victor plaster dog "His Masters Voice" display. Send snapshot and full information to Box 50, RADIO & TELEVISION NEWS, 366 Madison Ave., New York 17, N. Y.

WRITE FOR OUR BARGAIN "TABGRAM"
A Free Bonus with Every Order

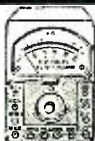

NEW IMPORTED "TAB" POCKET AC-DC Multifester
1000 Ohms Per Volt
Model 27c Hi-accuracy precision VOM. Reads AC & DC Volts: 0, 5, 25, 250, 1000 V. DCMA: 1, 10, 100 MA. OHMS: 0 to ∞. 100 K. Size 1 3/4"D. 4 1/2"L. 3 1/4"W. Test leads. plus 40¢ ship in U.S.A. **\$7.75**

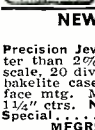

NEW "TAB" MINIATURE METER
0-1 Milliamp
Precision Jeweled D'Arsonval Meter. Better than 2% Accy. Readable long 1 1/2" scale, 20 divisions. Rugged. Well damped. Inexpensive case. Front Edge or Rear Round face mtg. Mounts 1 1/2" hole. 4 screws 1 1/2" ctrs. **NOT SURPLUS.** \$3.85; 2/\$7 Special. **MFGRS: WRITE FOR DISC.**



"TABTRON" HI CURRENT PWR SUPPLY
ONE YEAR GUARANTEE
Variable 0-28VDC. Completely Built. Incls: Full Wave Selenium Rectifier, Transformer, Variac, Volt & Amp Meters, Switch, Terminals & Fuse. 1 Hvy duty Steel Cabinet. Standard 115V/60cy Input or 220V and 3 phase to order. **SPECIFY.**
Stk. No. Cont. Rating W-Meters
T28V12A 0-28 VDC at 5 Amp \$ 50
T28V12A 0-28 VDC at 10 Amp \$125
T28V24A† 0-28 VDC at 24 Amp \$155
T28V50A† 0-28 VDC at 50 Amp \$285

NEW "TABTRON" SELENIUM BRIDGE Gtd. RECTIFIERS One Yr.

FOLLOWING LIST. FULL WAVE BRIDGE

Cont. Volts	18/14	36/28	52/42	130/100
1AMP	\$1.40	\$2.30	\$3.70	\$7.40
2AMP	2.00	2.95	5.30	10.25
3AMP	2.90	4.10	7.50	14.75
4AMP	3.50	6.40	11.25	25.00
6AMP	3.95	11.70	12.75	29.65
10AMP	7.20	17.50	22.00	43.85



NEW 15" HI-FI SPEAKERS
SOLD ON MONEY BACK GUARANTEE
Latest Design, Biggest & Best Ticonal SDC Magnet Assembly Wgt 18 lbs., 8 Ohm V.C. RATED 25 to 50 Watts. 15" Dia. 15" X 15" X 15" (20-20,000 cy) \$89
DUAL-CONE 15" (20-14,000 cy) \$69
WOOFER 15" (20-4000 cy) \$59

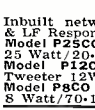

"TAB" HI-FI SPEAKERS
Inbuilt network 2 wires needed for HF & LF Response Famous Hi-Fi mfrs.
Model P25CO 15" Coaxial PM & 5" Tweeter 25 Watt/20-17500 cycles... \$19.50
Model P2CO 12" Coaxial PM & 5" Tweeter 12W/45-15K Cy... \$12.75
Model P8CO 8" Coaxial PM & 2 1/2" Tweeter 8 Watt/70-15K... \$7.75



NEW GE PHONO CARTRIDGES
*GE Original Boxed, \$ \$ \$ Back Gtd
RPX050A* .001 & .003 (SS) \$6.98
RPX052A* Golden Treasure (DS) \$19.98
RPX053A* Golden Treasure (DD) \$28.98
Replacement Needles "TETRAD" Diamond
RPJ013A Dual (DS) .001 & .003 "TETRAD" \$10.99
RPJ01D or RPJ03D Single (S) "TETRAD" \$9.99
RPJ015 or RPJ035 Single (S) "TETRAD" \$11.35
RPJ003 or RPJ004 Single (D) "TETRAD" \$9.99
MG or 78 Single (D) "TETRAD" \$9.89



FINEST HI-FI RECORDING TAPE
7 1/2" Reel—1200 Ft. Per Reel
\$ \$ \$ Back Guarantee
Precision Coated & Silt Gtd. Splice Free. Quality Controlled. Plastic Base. Gtd. Constant Output. Freq. 7 1/2 IPS 40-15K. Oxide Wnd. In. @ \$1.62 ea. 12 @ \$1.55 ea. 24 @ \$1.45 ea. 72 @ \$1.35 ea.

NEW, Unused • Individually Boxed TUBES FULL RETMA WARRANTY
No Electrical or Mechanical Rejects

024	.45	6AV5	.80	6K6	.45	12AX7	.55
1A2	.95	6AV6	.45	6S4	.45	12BA6	.50
1B3	.65	6AX4	.40	6SA7	.50	12BE6	.65
1R5	.50	6AX5	.75	6SJ7	.75	12BY7	.75
1T4	.50	6BA6	.45	6SK7	.50	12BY7	.97
1U5	.45	6BC6	.60	6SL7	.55	12CA7	.64
1X2	.85	6BE6	1.24	6SQ7	.55	12CN7	.56
3V4	.75	6BG6	1.24	6SQ7	.55	12DN7	.56
5U4	.45	6BK7A	1.11	6T4	1.15	12DQ7	.50
5V4	1.28	6BL7	1.90	6T6	.55	25B06	.90
5Y3	.65	6BN6	1.19	6V6	.55	50C5	.42
6AC7	.65	6BQ6	.90	6W4	.35	25W4	1.03
6AG5	.45	6B7A	1.30	6X4	.40	35L6	.69
6AK5	.60	6C4	.60	6X4	.40	35W4	.50
6AL5	.40	6CB6	.50	6X8	.85	35Z5	.45
6AG5	.45	6CD6	1.08	12AT7	.40	50B5	.70
6AT5	.40	12B7	1.22	12BY7	.75	50C5	.52
6AU4	.95	6CL6	1.65	12AV6	.41	50L6	.55
6AU5	1.10	6J5	.40	12AU7	.50	75	.85
6AU6	.45	6J6	.45	12AX4	1.28	83V	1.22



NEW "TABLITE" ELECTRONIC Flash Kit 400II
Compact Camera size case 6 7/8" Hgt. 2 3/4" Dpth. 3" Wdth. Uses New Lo-Cost Flash circuit 3¢ per flash, 1000 to 1200 flashes per set of Batteries. Color number + 40. Flash Pan + 200. Re-cycles 2 sec's. Simplified Kit (child can build). **LESS BATTERIES @ \$29.95. Set of Two (2) 240V Batteries @ \$10**



NEW PROFESSIONAL "TABLITE" Flash Kit 1000II
Includes Four 525MFD/450V Flash Condensers. Operates AC & Batteries. Guide number Color + 200. Fast Pan + 500. **LESS BATTERIES @ \$44.95. SET BATTERIES EXTRA @ \$10**
Flash Lamp Gun, Holder & 10" Wide Range Reflector. Special @ \$3.49. With DX Flash Lamp @ \$13.49
Photoflash Cond. 525MFD/450V/53W Sec'd. New low leakage. Famous mfr. @ \$8; 2/\$15

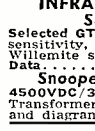

INFRARED SNOOPERSCOPE
See In Dark Tube
Selected GTD. Image Converter Tube. Hi-sensitivity, simplified design 2" dia. Willemite screen. Hi Resolution. Tube & Data... Special @ \$3.90; 2/\$7.50
Snooperscope Power Supply
4500VDC/35MA. Using Dual Doubler Ckt. Incls Transformer, Rectifiers, Sockets, Resistors, Capacitors and diagram 115V/60cy oper... \$13.50



"TAB" TERMS: Money Back Gtd (cost of mds only) \$5 min order F.O.B. N.Y.C. Add ship charges for C.O.D. 25¢. Dep. Tubes gtd. via R-Exp only. Prices shown subject to change.
111 LIBERTY ST., N.Y.C. REC'D 2-6245 DEPT. 3R-N-CABLE "TABPARTS"

INDEX OF Advertisers MARCH 1956

While every precaution is taken to insure accuracy, we cannot guarantee against the possibility of an occasional change or omission in the preparation of this index.

ADVERTISER	PAGE	ADVERTISER	PAGE
A. L. Products Co., Inc.	151	M. R. Company, The	155
Aaron Electronics	174	Major Brand Tube Co.	143
Acro Products Company	162	Mallory & Co., Inc., P. R.	75, Fourth Cover
Airex Radio Corp.	183	Marshall Manufacturing Co.	174
Allied Radio Corp.	9, 97, 98, 99	Merit Coil & Transformer Company	17
Altec Lansing Corporation	28, 122	Microtran	165
American School	143	Milwaukee School of Engineering	74
American Television & Radio Co.	160	Moss Electronic Distributing Co., Inc.	104, 105
Arrow Sales, Inc.	156	Music-Appreciation Records	11
Ashe, Radio Company, Walter	109	National Masterpiece Society, The	179
Audel, Publishers	159	National Company	119
B & K Manufacturing Co.	145	National Electronics of Cleveland	156
Baltimore Technical Institute	133	National Radio Institute	3, 7
Bell Telephone Laboratories	10	National Schools	29
Blonder-Tongue Laboratories, Inc.	124, 126	Newark Electric Company	128
British Industries Corp.	134	Northrop Aeronautical Institute	179
Burstein-Applebee Co.	167	Nuclear Products Co.	168
CBS-Hytron	21	Olson Radio Warehouse	113
Cabinet	159	Ortho-Sonic Instruments, Inc.	131
Candler System Co.	178	Oxford Electric Corporation	108
Capital Electronics	149	Pacific States University	173
Capitol Radio Engineering Institute	13	Peak Electronics Company	152
Century Electronics Co.	136	Philco Corporation	12
Channel Master Corp.	14, 15	Photo Circuits Corp.	180
Clearfield Surplus Sales	173	Pilot Radio Corporation, The	30
Cleveland Institute of Radio Electronics	32	Popular Photography	156
Colman Tool & Machine Co.	179	Post Electronics Company	112
Columbia Electronics	134	Precision Development Corp.	22
Commissioned Electronics, Inc.	174	Precision Apparatus Co., Inc.	182
Concord Radio	118	Precision Electronics, Inc.	158
Cornell-Dubilier	6	Premax Products	161
Coyne Electrical School	139, 165	Premier TV Radio Supply	130
Crown Controls Co., Inc.	167	Prentice-Hall Inc.	174
De-Ro Electronics	162	Presto Recording Corp.	111
DeVry Technical Institute	5	Progressive "Edu-Kits," Inc.	157
Dressner	139	Pyramid Electric Co.	20
Duotone Co., Inc.	172	Quality Electronics	174
Dyna Company	114	R.C.A. Institutes, Inc.	19, 155
Dynamic Electronics-New York, Inc.	128	RW Electronics	142
Eby Sales Co. of N. Y.	168	Radiart Corp., The	6
Editors and Engineers, Ltd.	177	Radio Corporation of America	73, 107
Electronic Chemical Corp.	106	Radio Ham Shack, Inc.	121
Electronic Instrument Co., Inc. (EICO)	33, 34, 139, 149, 151, 155	Radio Kits, Inc.	132
Electronic Specialties Mfg. Co.	148	Radio Products Co.	108
Electro-Voice	Second Cover, 8	Radio & Television News	171
E-Z Way Towers, Inc.	154	Radio-Television Training Association	23
Fair Radio Sales	133	Rad-Tel Tube Co.	154
Fisher Radio Corp.	91, 92, 93, 131	Ram Electronics Sales Co.	153
G & G Radio Supply Co.	151	Rauland-Borg Corporation	26
General Electric	123	Raytheon Manufacturing Company	24, 25
Goodheart, R. E.	151	Rek-O-Kut Company	115
Granco Products, Inc.	118	Research Invention & Manufacturing Co.	114
Greenlee Tool Co.	169	Rex Radio Supply	168
Gyro Electronics	143	Rinehart & Co., Inc.	89, 137, 163
Harjo Sales Co.	148	Ronette Acoustical Corp.	144
Hartley Products Co.	178	Sams & Co., Inc., Howard W.	101, 141
Harvey Radio Co.	138	Sarkes-Tarzan, Inc.	125
Heath Company	77, 78, 79, 80, 81, 82, 83, 84, 85, 86, 87, 88	Science Kits	172
Henry Radio Stores	173	Scott-Mitchell House, Inc.	180
Hershel Radio Co.	176	Seco Mfg. Co.	149
Hexacon Electric Company	182	Service Instruments Co.	146
Hickok Electrical Instrument Company, The	18, 133	Shure Brothers, Inc.	16
HI-FI ANNUAL & Audio Handbook	147	Solar Electronics	153
Hi-Lite Electronic Sales Co.	128	Sonotone Corporation	129
Howard Tools	175	Sperry Gyroscope Company	181
Hughes Research and Development Laboratories	76	Sprague	172
Hyon Electronics, Inc.	135	Stand-Burn Radio & Electronics Co.	158
Indiana Technical College	151	Standard Electrical Products Co.	100
Instructograph Company	173	Stanley Electronics Corp.	170
International Electronics Corp.	120	Stevens Manufacturing Corp.	163
International Radio & Electronics Corp.	116	Stevens Walden, Inc.	181
J. J. Glass Electronics Co.	108	Suprex	108
Jensen Mfg. Co.	139	Supreme Publications	127
Johnson Co., E. F.	178	Sylvania Electric Products, Inc.	27
Jones & Laughlin Steel Corporation	117	"TAB"	184
Karlson Associates, Inc.	168	Telemarine Communications Co.	146
Keil Engineering Products	180	Telephone Engineering Co.	178
Kester Solder Company	165	TeleTest Instrument Corp.	140
Klein & Sons, Mathias	164	Texas Crystals	144
Kuba Tonmoebel Und Apparate-Bau	136	Triad Transformer Corp.	90
Kuhn Electronic Products	166	Triplet Electrical Instrument Co.	3rd Cover
Lafayette Radio	110, 111, 186	Tri-State College	178
Lampkin Laboratories, Inc.	169	Tube Mart	140
Leotron Distributors	162	Tung-Sol Electric, Inc.	185
Lektron Specialties	154	U. S. Crystals, Inc.	158
Leonard Radio	148	United Catalogue Publishers, Inc.	143
L M B Box Chassis	133	United Radio Co.	143
McGee Radio Company	94, 95, 180	Universal TV School	116
McGraw-Hill Book Co., Inc.	180	University Loudspeakers, Inc.	165
		Valparaiso Technical Institute	168
		Viking of Minneapolis	155
		Weller Electric Corporation	161
		Western Electronics Institute	178
		Western Television Institute	149
		World Radio Laboratories	175

Classified

RATE: 50¢ per word. Minimum 10 words. May issue closes March 12th. Send order and remittance to: RADIO & TELEVISION NEWS, 366 Madison Ave., N. Y. C. 17.

RADIO ENGINEERING

COMPLETE radio, electronics theory & practice; television; broadcasting; servicing; aviation, marine, police radio. 18 or 21 months. Catalog. Valparaiso Technical Institute, Dept. N, Valparaiso, Ind.

FOR SALE

TRADE-IN Television Sets \$14. Jones Radio, 1115 Rambler, Pottstown, Pa.

DIAGRAMS—Radio \$1.00; record changers, recorders \$1.25. Television with service data \$2.00. Where model unknown, give part numbers. Kramer's Radio Service, Dept. JA5, 36 Columbus Ave., New York 23, N. Y.

TAPE Recorders, Tapes, Accessories. Unusual Values. Dressner, Box 66R, Peter Stuyvesant Station, N. Y. 9.

BC-348P RECEIVER, brand new, original carton, covers 6 bands, 200-500 kc., 1.5-18 mc. Designed for 28 v.d.c., easily converted to 117 v.a.c. \$75.00 f.o.b. New York. Box 51, % RADIO & TELEVISION NEWS.

DIAGRAMS for repairing radios \$1.00. Television \$2.00. Give make, model. Diagram Service, 106 Oliver Road, Manchester, Conn.

TV Trade-In sets. Philco, R.C.A., Emerson, others. List available. 10"—\$17. 12" to 17"—\$20. up. Washtek Service Co., Dept. R, 956 Southern Blvd., Bronx, N. Y.

TUBES—TV, Radio, Transmitting And Industrial Tubes At Sensibly Low Prices. New, Guaranteed, 1st Quality, Top Name Brands Only. Write For Free Catalog or Call Walker 5-7000, Barry Electronics Corp., 512 Broadway, New York 12N, N. Y.

TAPE Recorders, Tapes; Wholesale Prices. Klarston, 215 E. 88, New York City 28.

HIGH Fidelity mail orders shipped Prepaid And Insured. Distributors of Fisher, Pilot, Harmon Kardon, H. H. Scott, Interelectronics, Garrard, Miracord, Rex, Rek O Kut, Fairchild, Pickering, Electro Voice, Stephens, Wharfdale, Bozak, Reeves, Crestwood, Pentron And Columbia Tape Recorders. All Labels LP Records, Sealed—20% off List. 3 Speed, Dual Track English Tape Deck With 3 Motors—30-15,000 cps. Best Buy at \$79.50. Free Data, Write Today. Fidelity Unlimited, 63-03 39th Ave., Woodside 77, N. Y.

HEAR This. 100 Resistors, 1/2, 1, 2 Watts, \$1.00; 100 Ceramicons, Discs, Tubulars, \$1.00; 10 Volume Controls, \$1.00; 15 TV Coils, \$1.00; 10 Loops, \$1.00; 5 Cheater Cords, \$1.00; 20 Hi Watt Resistors, \$1.25; 10 F.P. Condensers, \$1.25; 25 Trimmers, \$0.50; 25 TV Knobs, \$1.50; 20 Sockets, \$0.75; 50 Radio Knobs, \$0.85; 50 Tie Lugs, \$0.50; 15 Connectors, \$1.00; Single Speed Motor, \$1.25; Triple Speed Motor, \$2.00; 25% With Order, Balance C.O.D.; F.O.B. N.Y.C. Grutman, One East 167th Street, N.Y.C. 52, N. Y.

TELEVISIONS, Trade-ins; Test Equipment. W4-APL, 1420 South Randolph, Arlington 4, Virginia.

SURPLUS, BC-1206-CM, used w/tubes, \$6.95. R15/cwr-7, 75mc superhet receiver, easily converted to 6 or 2 meters, used for 4 function model control, less tubes and case \$5.95. R-3-5 Receiver 2 for \$1.50. Attenuator L-101-A 30 to 100 db. \$9.95. T-17 Microphones, Used-Checked. \$3.50. 249C tubes, \$2.50. New Meters Burlington 3" O-IV-fs, \$2.25, Triplett 3" 0-150VAC, \$2.95, Triplett 3" 0-100 microamps, \$6.95. Capacitor, 8mf, 2500V oil, \$7.95. Minimum order \$2.50. 25% on C.O.D.'s. All orders F.O.B. Dallas. Texas Electronics, Rt. 1, Box 221B, Grand Prairie, Texas.

TV-FM antennas. All types including UHF. Mounts, Accessories. Lowest prices. Wholesale Supply Co., Dept. H, Lunenburg, Mass.

SCINTILLATION Crystals. NE-101 Plastic Phosphors at new low cost, with instructions for use. Scintillation counter circuit \$1. Uranium Yearbook \$2. Geiger tubes only \$5. Geiger counters \$37.50 to \$545. Scintillation counters \$289 to \$3500. Ultraviolet lamps. Metal detectors. Western Radiation Laboratory, 1107 West 24th Street, Los Angeles 7, California.

When you order by mail . . .

please print your name and address clearly, be specific in your order, enclose proper amount, allow ample time for delivery.

March, 1956

REPAIR Diagrams—Service Information—Illustrations! Radios—Record Changers—Recorders \$1.00. Televisions \$2.00. Give Make, Model, (Chassis Number). Rush? Air-Mail Add 20c, T.V. Miltie, Box 101-A Hicksville, New York.

WANTED

WANTED—Electronic Tubes, all types. Also want all types airborne electronic equipment. ART-13; BC-788; I-152; ARC-1; ARN-7, etc. Top dollar paid! Bob Sanett, W6REX, 1524 S. Edris Dr., Los Angeles 35, California.

CYLINDER and old disc phonographs. Edison Concert, Balmoral, Conqueror, Opera, and Oratorio models. Berliner Gramophones and Zono-ophones, Columbia disc and cylinder Graphophones. Betini micro-reproducer. Want old catalogues and literature on early phonos prior to 1919. Will pay cash or trade late hi-fi components. Box 50 % RADIO & TELEVISION NEWS.

AN/APR-4, AN/APR-9, other "APR-," "ARR-," "TS-," ARC-1, ARC-3, ART-13, everything surplus; Tubes, Manuals, Laboratory equipment. Describe, price in first letter. Engineering Associates, 434 Patterson Rd., Dayton 9, Ohio.

WILL Buy All ART-13 T47A Transmitters \$200.00. ART-13 T47 Transmitters \$150.00. BC-788C Altimeters, \$160.00. ARC-3 Complete \$185.00. R5/ARN-7 Radio Compass \$175.00. BC-348 Rec'r Modified \$25.00. BC-348 Rec'r Unmodified \$50.00. ARC-1 Radio Complete \$250.00. BC-312 Receiver \$40.00. BC-342 Receiver \$50.00. Ship via Express C.O.D. Subject to Inspection to: H. Finnegan, 49 Washington Ave., Little Ferry, N. J.

WANTED: ART-13 transmitters and parts—also ARC-1, ARC-3 and ARN-7. Have requirement for ARN-6 material, Iron Core Loops, need all types Collins and Bendix Aircraft Radio equipment. Florida Aircraft Radio & Marine, Inc. P. O. Box 205, International Airport Branch, Miami 48, Florida.

WANTED: Receiver R5/ARN-7, MN-62A Transceivers, RT18/ARC-1, AN/ARC-3, BC-788C, I-152C Collins. Bendix equipment. Test Sets, Dynamotors, Inverters. We pay highest prices. Advise quantity, condition, price first letter. Aircraft Radio Industries, Inc., 15 East 40th St., New York City, telephone LExington 2-6254.

TUBES and equipment bought, sold, and exchanged. For action and a fair deal write B. F. Gensler, W2LN1, 56 Crosby St., N. Y. 12N, N. Y.

HIGHEST prices paid for Surplus Radios—RT18/ARC1—ART 13—R5/ARN7—BC 788C—BC342 Etc. Write W2KUW, 308 Hickory, Arlington, N. J.

TOP Prices Paid For BC-348-H, K. L. R. S. Preferably Unmodified. Write, Giving Complete Information On Model, Condition And Best Price. Industry Services, Inc., 2705 South Oakland Street, Arlington 6, Virginia.

REPAIRS AND SERVICING

HIGH Fidelity Speakers Repaired. Amprite Speaker Service, 70 Vesey St., New York 7, N. Y. Ba. 7-2580.

BUSINESS OPPORTUNITIES

2000 SIGN Slogans & Clock sign \$1.00. Make money with hobbies, Book \$1.00. ABC-RTN1, 2227 So. Park, Buffalo 20, N. Y.

CORRESPONDENCE COURSES

USED Correspondence Courses and Books sold and rented. Money back guarantee. Catalog free. (Courses bought.) Lee Mountain, Pisgah, Ala.

USED Correspondence courses and educational books bought, sold, rented. Free Catalog. Educational Exchange, Menlo, Georgia.

RECORDS

PHONOGRAPH Records Cheap. Catalogue. Paramount, NA—313 East Market, Wilkes-Barre, Penna.

MISCELLANEOUS

1,000 BUSINESS Cards, \$2.99. Samples free. Hontz's, 1009-W Hill, Phillipsburg, N. J.

TUBES FOR THE FINEST IN HI-FI

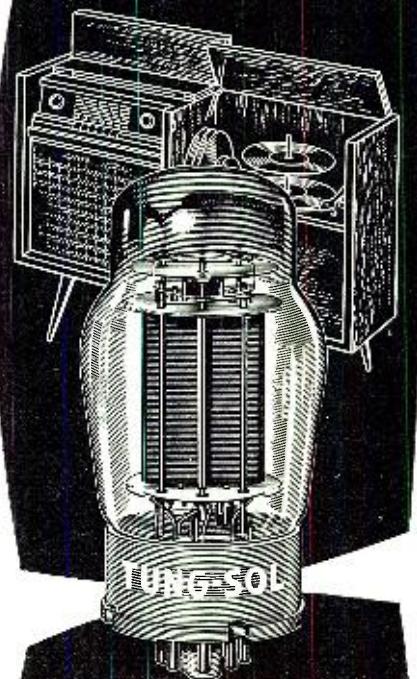

Almost without exception, makers of the finest high-fidelity sets depend upon Tung-Sol Audio Amplifier Tubes to help deliver the performance expected of their products.

Through these tubes—the "5881" and the "6550"—Tung-Sol clearly demonstrates its ability to meet and maintain high-fidelity's critical design requirements in volume production.

This achievement is indicative of the quality and dependability of Tung-Sol Hi-Fi, Radio and TV Tubes . . . products of America's largest independent electron tube manufacturer, Tung-Sol Electric Inc. Newark 4, N. J.

TUNG-SOL
ELECTRON TUBES

Tung-Sol Automotive & Electronic Products

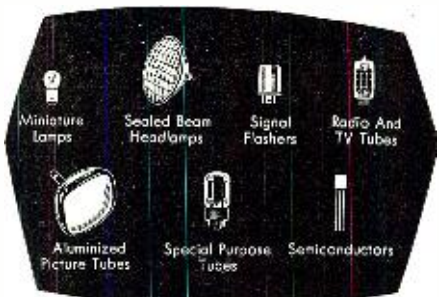

FREE!

LAFAYETTE

CATALOG



132 PAGE ELECTRONIC CATALOG

Packed with the largest selection of Electronic, Radio and T.V. Parts, and equipment, PA, Hi-Fi systems, tubes, antennas, Transistor Kits, parts and components, Test Equipment, new build your own kits, tools, books, Microscope, drafting equipment, Binoculars, Telescopes, All Radio TV and Ham supplies — ALL AT GREAT SAVINGS — For the economy minded servicemen, dealer, engineer and technician. **CHUCK FULL OF BUYS! SEND FOR YOUR FREE COPY TO-DAY.**

Just a few of Lafayette's Values

2 TRANSISTOR POCKET RADIO KIT



Packed into a 2 1/2" x 3 1/2" x 1 1/4" plastic case. This Two Transistor plus crystal diode radio kit offers many surprises, utilizing a regenerative detector circuit with transformer coupled audio stage, gives you high gain and excellent selectivity. Pulls in distant stations with ease with more than ample earphone volume. Kit comes complete with two transistors, crystal diode, loopstick, Arzonne transistor audio transformer, resistors, condensers, plastic case, etc. Including schematic and instructions.

KT-68A Complete Kit less earphones. **11.80**
 Net
 MS-260 New "Super Power" Dynamic Earphone. Ideal for Transistor. Cpu! Imp. 8000 ohm D.C. 2000 ohm **3.95**

HIGH-FIDELITY TURNOVER CARTRIDGE

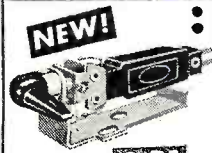

- 40-14000 CYCLE
- NEVER BEFORE AT SUCH A PRICE!

Lafayette brings you one of the finest high-fidelity turnover cartridges, AT AN UNBELIEVABLE PRICE! Frequency response from 40-14000 cycles + 2 db. Has 2 sapphire styli to play all speeds. Needle pressure only 5 grams on LP cond 12-15 grams on 78. Output is .5 volts. Complete with turnover mechanism and knob, fits Webster, Garrard, VM, Collaro and tone arms of leading manufacturers of record changers and players.

Reg. Price ~~8.50~~

PK-79Singly, Each **2.75**
 In lots of 3, Each **2.50**

SLIM HIGH OUTPUT DYNAMIC MICROPHONE



Reg. Price ~~11.50~~ Net **9.95**

A pencil-slim design, high output PA Dynamic Microphone of exceptional quality, at a price that is 1/2 of the price of any comparable microphone on the market today. Very smooth response, 60-10,000 cycles. Omnidirectional, tiltable head. Switch on side gives choice of either high impedance (250 ohms), or low impedance (25 ohms). Instantly removable bracket permits use either on stand or as hand mike. Features exceptional mechanical strength. Cast case with satin chrome finish, 3/8"-27 thread, Acoustically-treated grille head, 3" long; 1 1/4" barrel diameter. Shipping weight 2 lbs.

PA-29In lots of 3, Each **9.25**
 Singly, Each **9.95**

TRANSISTOR CHECKER KIT



● Checks Shorts, Leakage, and Gain A "must" for servicemen, experimenters and engineers. Tests both PNP and NPN type transistors. Gives 2 separate checks; first GOOD-BAD check for shorts and leakage, and second for GAIN. Gray hammettone case 5 1/4" x 3" x 2 1/4". Kit includes case, meter, all parts with full assembly and operating instructions. Simple to build. Fast, accurate. Shpg. wt. 3 lbs.

KT-66 Kit **7.95**

NEW POCKET AC-DC VOM MULTITESTER



2,000 ohm per Volt on AC & DC

● Completely wired — Not a kit Accurate VOM with a sensitivity of 2000 ohms per volt on both AC and DC. Single selector switch, 3" 160 amp. meter. Scales: DC Volts: 0-10-50-500-1000; AC Volts: 0-10-50-500-1000; Ohms: 0-10K, 0-1 Meg; DC Current: 500 ua and 500 ma; Decibel: -20 to +22, +20 to 36; Capacity: 250 mfd to .2 mfd and .005 to 1 mfd. Heavy plastic panel, metal bottom. 4 1/4" x 3 1/2" x 1 3/8". With batteries and test leads. Shpg. wt. 4 lbs.

7.95

RW-27A **7.95**

TRANSISTOR LOOP ANTENNA



TRANSISTOR 455 KC I.F.

Specially designed for transistor circuits, only 1/2" square by 3/4" high. MS-126 In lots of 10, each **79¢**
 Single, Each **89¢**

Fixed impedance tapped to match 800 ohm input. Covers 540-1650 kc with 365 mmf variable cond. size 9/16 x 4 1/8". Net **1.25**

HIGH SENSITIVITY 20,000 OHM PER VOLT DC 10,000 OHM PER VOLT AC MULTITESTER



35 ua 3" METER SILVER CONTACT SELECTOR SWITCH 1% PRECISION RESISTOR

LOOK AT THESE FULL SCALE RANGES!
 D.C. VOLTS: 0-6; 0-30; 0-120; 0-600; 0-1200; 0-6000 Volts—A.C. VOLTS: 0-6; 0-30; 0-120; 0-600; 0-1200 Volts—RESISTANCE: 0-10K; 0-100K; 0-1 Meg; 0-10 Megohms—D.C. CURRENT: 0-60 Microamp; 0-6; 0-60; 0-600 Millamps—DECIBEL: -20 to +17 db (0 db 0.774V)—CAPACITY: 0.001 - 0.1; 0.05 - .15 mfd—INDUCTANCE: 20-2000 millihenry—OUTPUT RANGES: 0-6; 0-30; 0-120; 0-600; 0-1200 Volts

The new Lafayette high sensitivity Multimeter is a complete instrument (not a kit). In addition to its unusual sensitivity of 20,000 OHMS PER VOLT ON D.C. AND 10,000 OHMS PER VOLT ON A.C., and the extraordinary number and scope of its ranges, it is packed with features that would make it cost at least twice as much if made in this country. Uses 1% precision resistors, silver contacts on selector switch, 35 ua 3" meter. Size: 6 1/4" x 4 1/4" x 2 1/2". Complete with batteries and leads. Shipping weight 4 1/2 lbs.

RW-30ASingly, Each **19.95**
 In lots of 3, each **19.25**

The Hi-Fi Phono System Buy Of The Year

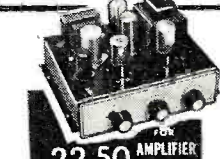

8 WATT PUSH-PULL AMPLIFIER WITH PREAMP FOR G.E. RELUCTANCE CARTRIDGE

This High-Fidelity 8 watt amplifier offers superb reproduction at a lower than ever price. Frequency response = ±1 db at 30 - to 20,000 cycles. Push-pull output for minimum distortion at normal level — only 1% at full 8 watts output. Noise level 90 db below rated output. Separate bass and treble controls — 15 db bass boost and treble attenuation. Self contained pre-amplifier designed for use with variable reluctance and magnetic type cartridges (crystal cartridges cannot be used). Tubes: 1-6SC7, 1-6SL6GT, 2-6V6GT, 1-6X5GT. Output impedance 4-8 and 16 ohm. Size 9" x 7" x 5 1/2". For 110-125 Volt 60 cycle AC operation.



AUTOMATIC HI-FI COMBINATION SYSTEM WITH G.E. 12" 25 WATT SPEAKER

The complete HI-FI Phono system including the Lafayette LA-21 HI-FI 8 watt push-pull amplifier. The latest model Collaro R-C-54 Intermix 3 speed changer, with the G. E. RFX-050A Turnover cartridge and G. E. 12" HI-FI 25 watt PM speaker complete system.

Collaro R-C-54

LA-21 Shpg. wt. 10 lbs.NET **22.50**
 SY 20NET **69.50**

LAFAYETTE TIME + 1/2 TAPE 1800 FT. - 7 INCH REEL



\$2.59 Each, Singly

\$2.45 Each, Lots of 10

AN ENTIRE SYMPHONY ON ONE REEL OF TAPE! NO MORE ANNOYING INTERRUPTIONS!

Lafayette did it again! New plastic base. TIME + 1/2 High Fidelity Recording Tape at an amazingly low price! Over 1 1/2 hrs. of playing time on a single reel at 7 1/2" per second on dual track recording. At 3 1/2" per second you get 3 hours and 12 minutes. The same quality that has made the Lafayette Standard Tape the nation's outstanding value. 40-15,000 cycle response at 7 1/2" per second assures you of the finest professional quality high fidelity recordings. A true Lafayette value backed up with our Money Back Guarantee. You be the judge—try it!

LAFAYETTE TIME + 1/2 TAPE } Lots of 10, Each **\$2.45**
 1800 FT. - 7 INCH REEL } Singly, Each **\$2.59**

CRYSTAL MICROPHONE

COMPARE IT WITH ANY MIKE AT 2 TO 3 TIMES THE PRICE

A quality crystal Microphone for PA systems, house recorders, etc. Frequency response 50 to 10,000 cycles. Output level -52 db. Provides ample output for use with low gain amplifiers. Complete with 5 ft. of shielded cable. Shpg. wt. 3 1/2" lbs.

PA-24 — in lots of 3, each .. **3.95**
 singly, each **4.25**



REMOTE CONTROL FOR SILENT TV VIEWING

● For Hard-of-Hearing

● For Late Listening

One or two people can both see or hear the program with the loud speaker cut-off. The hard-of-hearing can listen to radio or TV without turning the volume so high that others can't stand the noise. Comes complete with miniature phone and 20 ft. cable. Shpg. wt. 3 lbs.

MS-125Net **6.50**



FREE! BUILD YOUR OWN TRANSISTOR RADIOS COMPLETE 8 PAGE BROCHURE

Lafayette Radio DEPT. RC
 BRONX, N.Y. 542 E. Fordham Rd.
 NEWARK, N.J. 24 Central Ave.
 NEW YORK, N.Y. 139 West 2nd St.
 BOSTON, MASS. 110 Federal St.
 Include postage with order.

Send FREE 132-Page Lafayette Catalog

Name _____
 Address _____
 City _____ Zone _____ State _____

ACTUAL SIZE

complete with selector switch...

TRIPLETT

ELECTRICAL INSTRUMENT CO.
Bluffton, Ohio

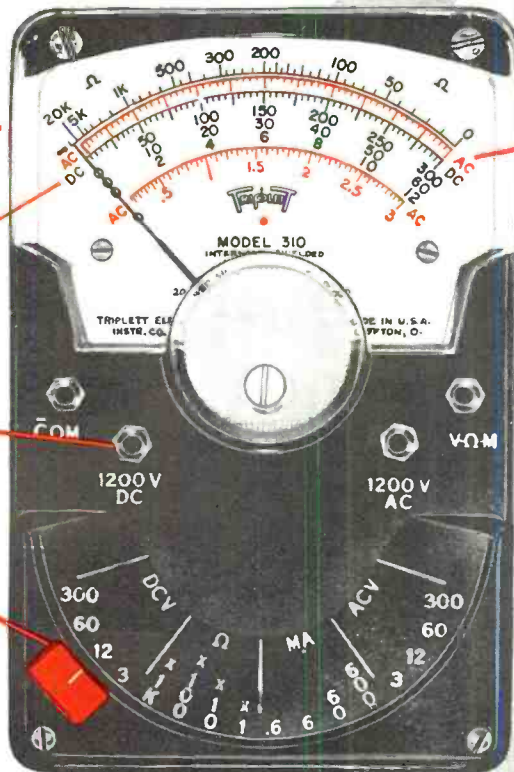

• 20,000 ohms per volt. D.C.

• BANANA-TYPE JACKS—positive connection and long life.

• EXCLUSIVE SELECTOR SWITCH speeds circuit and range settings. The first and only miniature VOM with this exclusive feature for quick, fool-proof selection of all ranges.

• 5,000 ohms per volt. A.C.



CARRYING CASE

Handsome leather carrying case with adequate space for Model 310 tester and accessories. Trouser belt slips through loop on back of the case for out-of-the-way carrying. MODEL 369 CASE—U.S.A. Dealer Net..... \$2.90

• SELF-SHIELDED FOR CHECKING IN STRONG MAGNETIC FIELDS. Self-shielded, rugged, higher-torque Bar-Ring instrument movement (exclusively Triplett).

Model **310** MIGHTY MITE

the only complete miniature V-O-M (AC-DC)

LOOK AT ALL THESE RANGES

DC VOLTS: 0-3-12-60-300-1200 at 20,000 Ohms/Volt.
AC VOLTS: 0-3-12-60-300-1200 at 5,000 Ohms/Volt.
DC MICROAMPERES: 0-600 at 250 Millivolts.
DC MILLIAMPERES: 0-6-60-600 at 250 Millivolts.
OHMS: 0-20,000-200,000 (200-2000 at center scale).
MEG OHMS: 0-2-20 (20,000-200,000 Ohms at center scale).
OUTPUT: Convenient chart in instruction book.
SEE IT AT YOUR JOBBER
AND IT'S ONLY ONE OF TRIPLETT'S MIGHTY NINE VOM LINE!

ONLY **\$29⁵⁰** Dealer Net

BURTON BROWNE ADVERTISING



631
Combination
V-O-M—VTVM

630-NA
For Best Testing
Around The Lab,
Production Line
or Bench

630
The Popular
All-Purpose
V-O-M

630-A
A Good Lab and
Production Line
V-O-M

310
The Smallest
Complete V-O-M
With Switch

630-T
For Telephone
Service

666-HH
Medium Size
For
Field Testing

625-NA
The First V-O-M
With 10,000
Ohms/Volt AC

666-R
Medium Size
With
630 Features

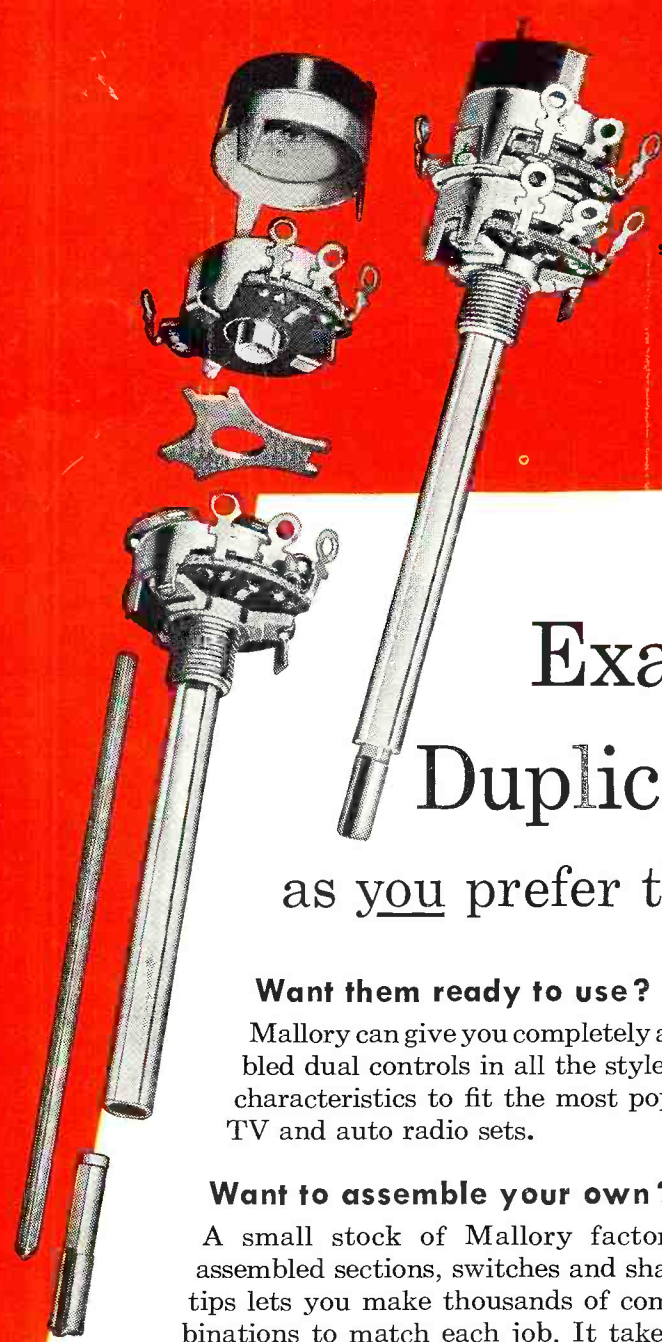

... another
MALLORY
service-engineered
product

Exact Duplicates

as you prefer them

Want them ready to use?

Mallory can give you completely assembled dual controls in all the styles and characteristics to fit the most popular TV and auto radio sets.

Want to assemble your own?

A small stock of Mallory factory-assembled sections, switches and shaft tips lets you make thousands of combinations to match each job. It takes you only a few minutes to complete the control you need, and you save all the time of shopping for the right combination.

You're right either way —

with Mallory. Mallory Dual Controls assure you of duplicating the exact characteristics you require . . . with noise-free, long-lasting, stable controls that assure customer satisfaction. Your Mallory distributor carries a full stock of both types. See him today!

P. R. MALLORY & CO. Inc.
MALLORY

P. R. MALLORY & CO. Inc., INDIANAPOLIS 6, INDIANA

- Capacitors • Vibrators • Resistors • Controls • Switches
- Rectifiers • Power Supplies • Filters • Mercury Batteries